



**Dental Catalog
Catalogo Dentale**

Dental Catalog / Catalogo Dentale



Falcon Medical Italia Srl.

Office address / Sede operativa:

Via S. Donato, 2045

55100 Lucca, Italy

tel: +39 0583 490459

+39 0583 511023

fax: +39 0583 463628

info@falconmedical.it

www.falconmedical.it

Legal address / Sede legale:

Via dei Bichi, 340

55100 S. Marco, Lucca - Italy



The Company

Falcon Medical Italia is the Italian daughter company of Falcon Surgical, a leading manufacturer which for over thirty years has specialized in manufacturing instruments for surgery, dentistry, dental laboratories, cranio maxillo facial surgery, body care and veterinary.

Thanks to continuous innovation and the use of certified raw materials, Falcon Surgical has been able to develop such a comprehensive variety of instruments as to satisfy the varying and increasingly severe requirements of an international audience both in terms of quality and range.

To date Falcon Surgical is present with own subsidiaries in Germany, England, Italy and Poland.

L'azienda

La Falcon Medical Italia è l'emanazione nazionale di un'azienda leader, la Falcon Surgical, che da oltre 30 anni si è specializzata nella produzione di strumenti per odontoiatria, odontotecnica, chirurgia cranio maxillo facciale, veterinaria, chirurgia e bodycare.

Grazie ad una continua innovazione e all'utilizzo di materie prime certificate, la Falcon Surgical è riuscita a realizzare una gamma completa di strumentario capace di soddisfare le più sofisticate esigenze di una platea internazionale sia in termini qualitativi che di gamma.

Ad oggi la Falcon Surgical è presente con proprie filiali in Germania, Inghilterra, Italia, Polonia.



Quality Guarantee

As a result of the experience accumulated in over three decades and the stringent quality control tests both in production and at the final stages of manufacturing Falcon Surgical is in a position to guarantee a consistent level of quality of any product in their range.

Garanzia di qualità

Grazie ad un'esperienza trentennale e ai severi controlli in produzione e finali la Falcon Surgical è in grado di assicurare le più ampie garanzie di qualità costante di ogni suo prodotto.



Customer Care

Our customer care department will be glad to help vis a vis any request for assistance.

Assistenza clienti

Un servizio clienti sarà comunque a Vostra disposizione per ogni tipo di assistenza o richiesta.



Manufacturing Activities

All Falcon Instruments are made using state of the art materials and manufacturing techniques which extend to the use of sophisticated metals and alloys such as titanium and nickel titanium.

All manufacturing activities are performed under Quality Assurance conditions as laid forth by the EN ISO 9001 and 13485 norms (all of which has been certified and is being continuously monitored by recognised international bodies) and in compliance with all laws and directives ruling the distribution of Medical Devices.

La produzione

Tutto lo strumentario Falcon viene prodotto utilizzando materiali e tecniche costruttive allo stato dell'arte che comprendono in alcuni casi metalli o leghe nobili quali (ad esempio) titanio e nichel titanio.

La produzione avviene in regime di Assicurazione Qualità secondo le norme EN ISO 9001 e 13485 (come certificato e costantemente monitorato dai riconosciuti organismi internazionali preposti) e nel rispetto di tutte le Leggi e Direttive che regolano l'immissione in commercio dei dispositivi medici.



Your satisfaction
is our
#1 priority

Contents / Contenuto

Diagnostic / Diagnostica 01 - 12



Photography / Fotografia 13 - 18



Periodontal / Parodontologia 19 - 26



Endodontics / Endodonzia 27 - 36



Restorative / Conservativa 37 - 66



Anesthesia / Anestesia 67 - 74



Atraumatic Extraction / Estrazione atraumatica 75 - 82











Extraction / Estrazione 83 - 104



Dental Surgery / Chirurgia dentale 105 - 120



Implantology / Implantologia	121 - 130	
Micro Instruments / Micro strumenti	131 - 134	
Surgery / Chirurgia	135 - 150	
Impression / Impronta	151 - 158	
Laboratory Instruments / Strumenti per laboratorio	159 - 172	
Orthodontics / Ortodonzia	173 - 194	
Sterilization and Sundries / Sterilizzazione e Varie	195 - 204	
Index / Indice	205 - 223	



Diagnostic
Diagnostica

Diagnostic Diagnostica

Mouth Mirrors / Specchietti per Bocca



Easy
COLOR Instruments



- Made of 18-8 stainless steel
- Sterilizable up to 200° C
- Best reflection and image quality
- Prodotti con acciaio Inox 18-8
- Sterilizzabili fino a 200° C.
- Qualità superiore per immagine e riflessione

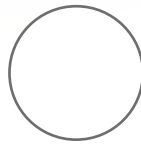

Fig. 2
Ø 18 mm

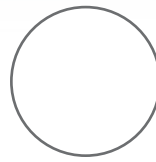

Fig. 3
Ø 20 mm

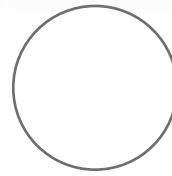

Fig. 4
Ø 22 mm

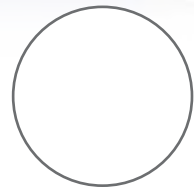

Fig. 5
Ø 24 mm



SS-200 Mirrors		Pack of 12 / Conf. 12 pz.		
		Rear surface / Riflessione dorsale		
Fig.	Ø mm	Chrome / Cromato	Magnifying / Concavo	Plane / Piano
2	18	-	DD.506.020	DD.509.020
3	20	-	DD.506.030	DD.509.030
4	22	DD.503.040	DD.506.040	DD.509.040
5	24	DD.503.050	DD.506.050	DD.509.050

SS-200 Perfection mirrors / Specchietti mod. 'Perfection'



- Wide stem offers comfortable cheek retraction
- Non glare satin finish
- Stelo largo utilizzabile per tenere la guancia divaricata
- Satinato per evitare riflessi di luce



Front surface / Riflessione frontale

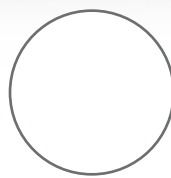

DD.515.040
Fig. 4
Ø 22 mm

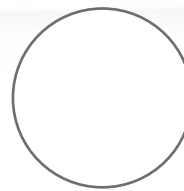

DD.515.050
Fig. 5
Ø 24 mm

Micro mirrors / Micro specchietti



Front surface / Riflessione frontale



DD.494.000
Fig. 000
Ø 10 mm



DD.495.000
Fig. 00
Ø 12 mm

Mirror handles / Manici per specchietti

- Key features
- Extra light
 - Silicone handle
 - Aluminum core
 - Optimal grip

- Caratteristiche
- Ultraleggeri
 - Rivestimento in silicone
 - Anima in alluminio
 - Grip ottimale



Easy
COLOR Instruments



DD.528.010
Black / Nero



DD.528.020
Blue / Blue



DD.528.030
Light Blue / Azzuro



DD.528.040
Brown / Marrone



DD.528.050
Green / Verde



DD.528.060
Grey / Grigio



DD.528.070
Orange / Arancione



DD.528.080
Pink / Rosa



DD.528.090
Purple / Viola



Diagnostic Diagnostica

Mirror handles / Manici per specchietti



Easy
COLOR Instruments



DD.528.100
Red / Rosso



DD.528.110
Turquoise / Turchese



DD.528.120
White / Bianco



DD.528.130
Yellow / Giallo

Mirror handles hollow / Manici vuoti per specchietto



DD.532.080



DD.530.010



DD.545.010

DD.545.015
Pack of 5 pieces / Confezione di 5 pezzi

Mirror handles solid / Manici pieni per specchietto



DD.520.010



DD.522.010

DD.522.015
Pack of 5 pieces / Confezione di 5 pezzi



DD.540.010

DD.540.015
Pack of 5 pieces / Confezione di 5 pezzi



DD.540.020

Explorers double ended / Sonde doppie

Key features

- Extra light
- Silicone handle
- Aluminum core
- Optimal grip

Caratteristiche

- Ultraleggeri
- Rivestimento in silicone
- Anima in alluminio
- Grip ottimale



Easy
COLOR Instruments



DD.140.021
Fig. 5/8



DD.140.011
Fig. 3/6



DD.140.031
Fig. 5/9

Explorers single ended / Sonde singole



DD.350.081
Fig. 8



DD.350.091
Fig. 9



DD.350.171
Fig. 17



DD.350.231
Fig. 23



DD.350.291
Holst
Fig. 29

Probe Single Ended / Sonda Millimetriche Singole



DD.750.151
WHO
Fig. 550B



Diagnostic Diagnostica

Explorers double ended rigid / Sonde doppie rigide

Classic Round 6 mm solid handle
Manico pieno da 6mm

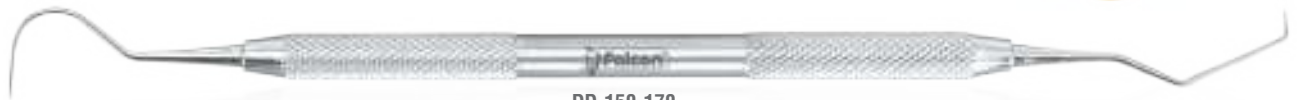

DD.150.170
Fig. 23/17



DD.150.171
Fig. 23/17A



DD.150.160
Fig. 23/16



DD.160.170
Pack of 5 explorers Fig. 23/17 / Confezione di 5 sonde Fig. 23/17

Explorers double ended flexible / Sonde doppie flessibili



DD.101.020
Fig. 2



DD.101.030
Fig. 3



DD.101.050
Fig. 5

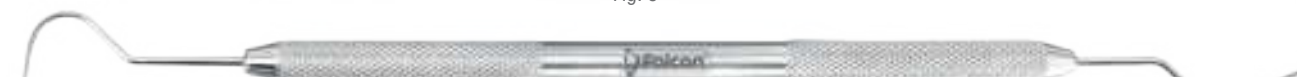

DD.181.023
Fig. TU17/23



DD.151.623
Fig. 6/23



DD.161.050
Pack of 5 explorers Fig. 5 / Confezione di 5 sonde Fig. 5

Explorers single ended rigid / Sonde singole rigide

Classic Round 6 mm solid handle
Manico pieno da 6mm

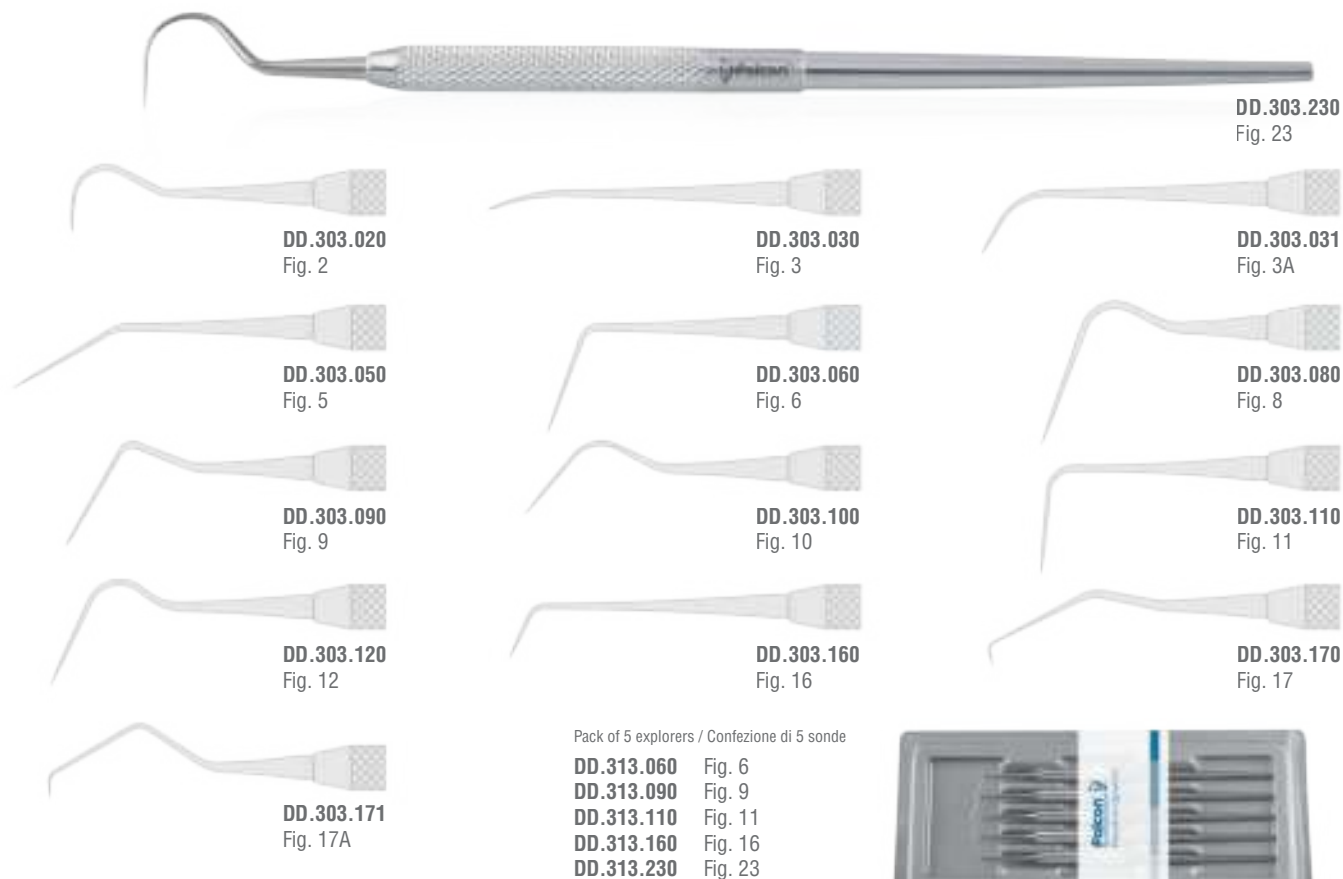

Explorers single ended flexible / Sonde singole flessibili

Classic Round 6 mm solid handle
Manico pieno da 6mm

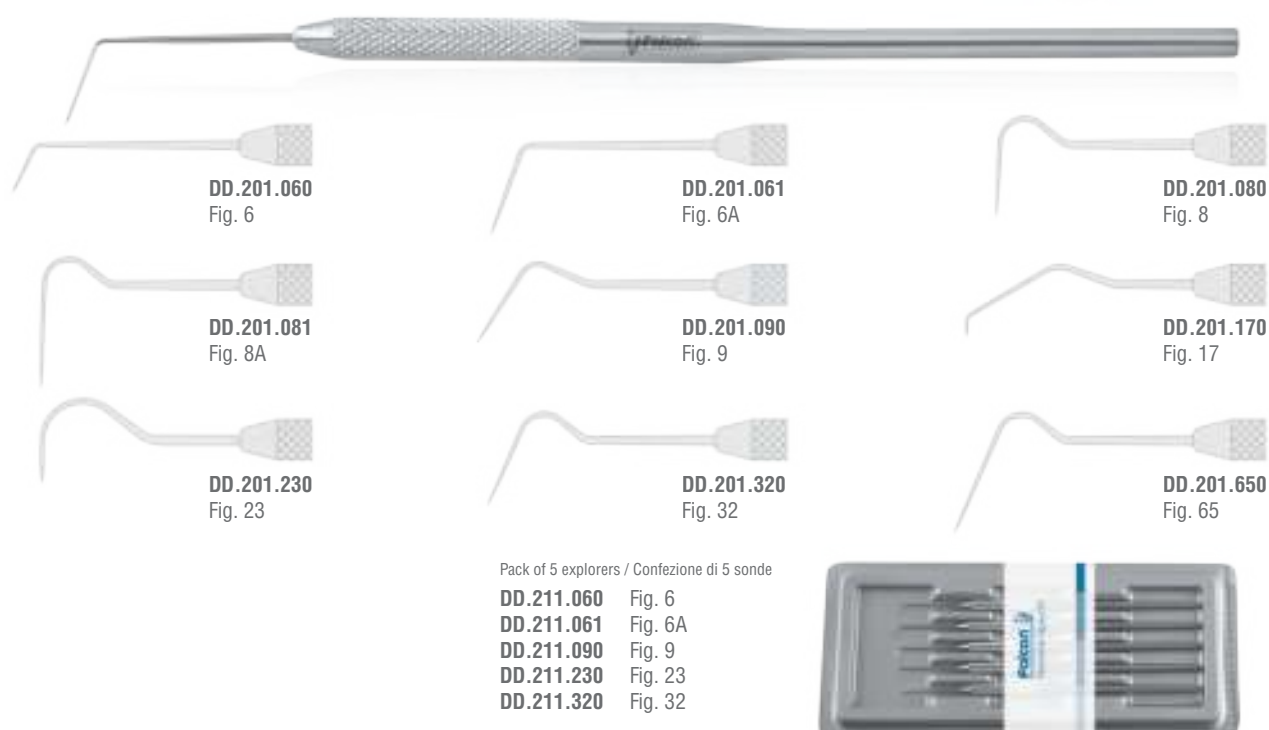

Diagnostic Diagnostica

Expro (explorer-probe combination) / Expro (combinazione sonda / sonda millimetrica)

Color Coded

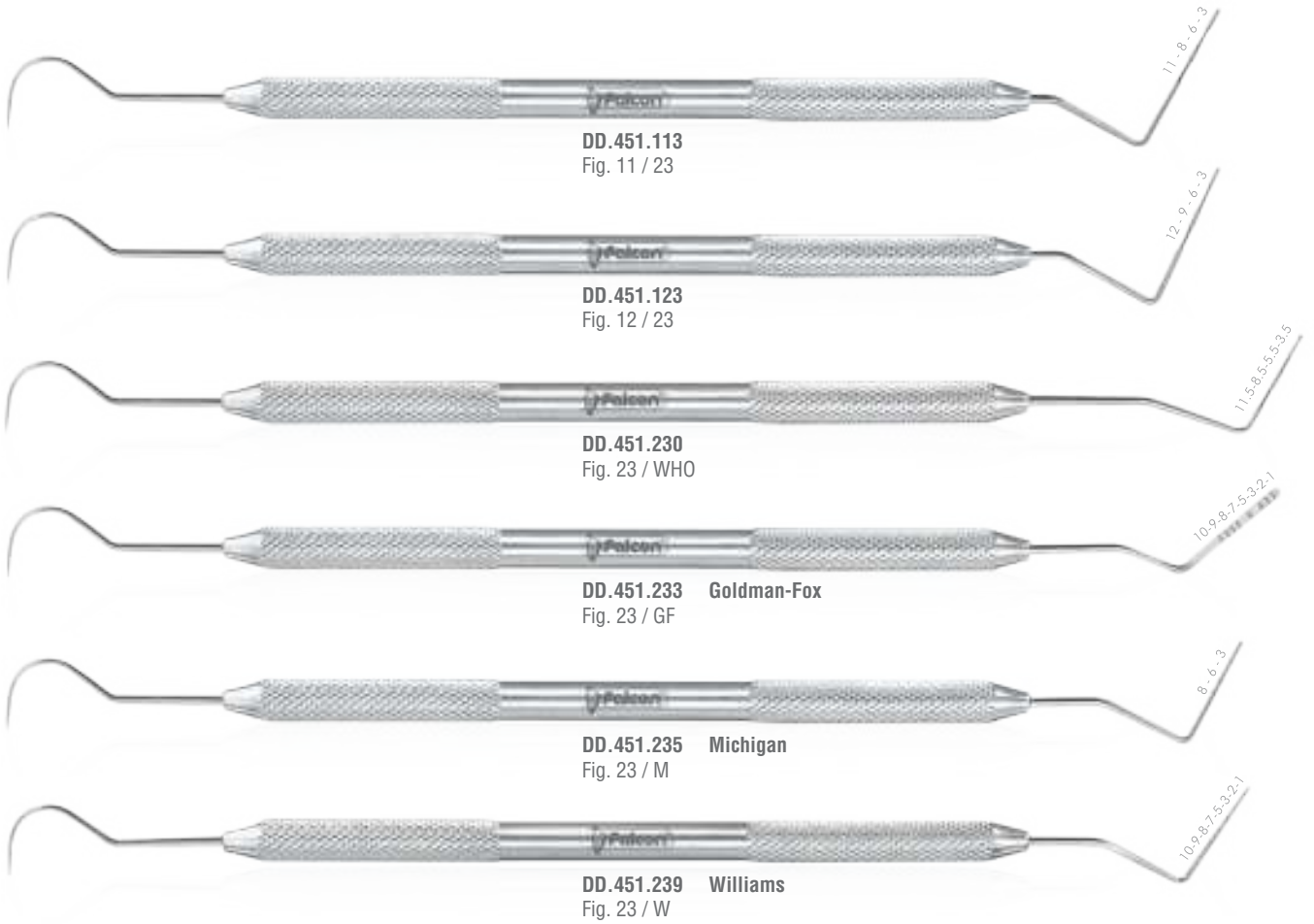

Probes double ended / Sonde doppie millimetriche



Probes Single Ended / Sonde Millimetrique Singole

Color Coded

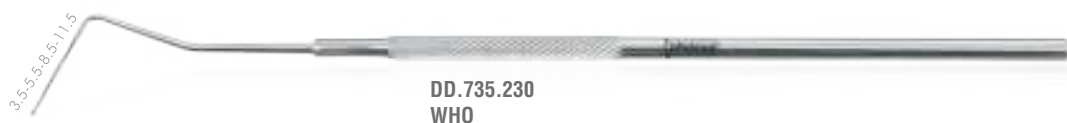
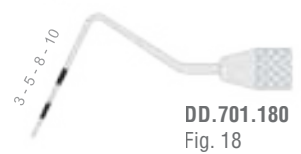
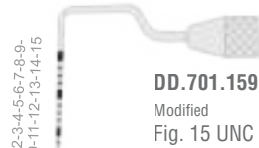
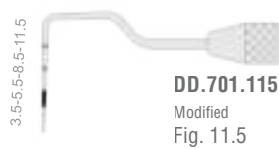
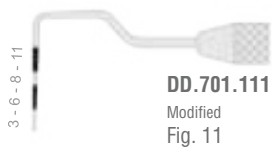

Diagnostic Diagnostica

Tweezers / Pinzette



DD.890.010
College
150 mm



Tweezers / Pinzette

Made of 18-8 non-magnetic stainless steel / Realizzate in acciaio antimagnetico 18-8



DD.900.150
College
150 mm



DD.901.150
Meriam
150 mm



DD.909.050
College
150 mm



DD.929.050
College-Locking
150 mm



DD.934.010
Flagg
160 mm



DD.944.010
Meriam
160 mm



DD.978.130
Perry
130 mm



DD.979.130
Perry
130 mm

Tweezers / Pinzette



DD.911.050
College TOE
150 mm

TOE (Turn over ends)



- Absence of welding leads to:
- Higher corrosion resistance
- Easier to clean



DD.946.010
Meriam TOE
160 mm

- Assenza della saldatura comporta:
- Più elevata resistenza alla corrosione
- Più facili da pulire

Pack of 5 tweezers / Confezione di 5 pinzette

DD.909.055 College
DD.934.015 Flagg
DD.944.015 Meriam



First Examination Instruments Kits, with Flexible Explorer Kit Strumenti Prima Visita, con Sonda Flessibile



Fig. 6A

DD.996.061

Contents / Contenuto
1 x DD.201.061
 1 x DD.509.040
 1 x DD.522.010
 1 x DD.909.050



Fig. 9

DD.996.090

Contents / Contenuto
1 x DD.201.090
 1 x DD.509.040
 1 x DD.522.010
 1 x DD.909.050



Fig. 23

DD.996.230

Contents / Contenuto
1 x DD.201.230
 1 x DD.509.040
 1 x DD.522.010
 1 x DD.909.050

First Examination Instruments Kits, with Rigid Explorer Kit Strumenti Prima Visita, con Sonda Rigida



Fig. 6A

DD.997.060

Contents / Contenuto
1 x DD.303.060
 1 x DD.509.040
 1 x DD.522.010
 1 x DD.909.050



Fig. 9

DD.997.090

Contents / Contenuto
1 x DD.303.090
 1 x DD.509.040
 1 x DD.522.010
 1 x DD.909.050



Fig. 23

DD.997.230

Contents / Contenuto
1 x DD.303.230
 1 x DD.509.040
 1 x DD.522.010
 1 x DD.909.050

Diagnostic Diagnostica

First Examination Instruments Kits, with Rigid Explorer Kit Strumenti Prima Visita, con Sonda Rigida



Fig. 6

DD.997.062
Contents / Contenuto
1 x DD.303.060
1 x DD.509.050
1 x DD.522.010
1 x DD.909.050



Fig. 9

DD.997.092
Contents / Contenuto
1 x DD.303.090
1 x DD.509.050
1 x DD.522.010
1 x DD.909.050



Fig. 23

DD.997.232
Contents / Contenuto
1 x DD.303.230
1 x DD.509.050
1 x DD.522.010
1 x DD.909.050

Tray for first examination kit / Vassoi porta strumenti prima visita (Instruments not included / Strumenti non inclusi)



DZ.094.000
Petite
Stainless Steel for 3 instruments
Acciaio inox per 3 strumenti
185 x 50 x 15 mm



Photography
Fotografia

Photography Fotografia

Intraoral photographic mirrors Specchi per foto intraorali

- Made of stainless steel
- Double sided
- No double reflection
- Provides sharp images
- Realizzati in acciaio inox
- Bilaterali
- Evitano la doppia riflessione
- Immagini ad elevata risoluzione



Autoclavabile
Autoclavabile

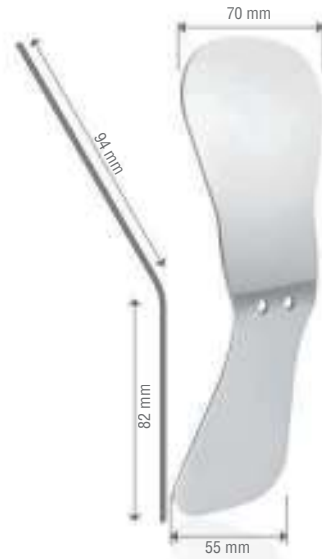

DD.468.010
Adult palatal / child palatal
Palatale adulto/ palatale bambino



DD.468.020
Buccal
Buccale



DD.468.030
Adult palatal / child palatal
Palatale adulto/ palatale bambino



DD.468.040
Adult palatal / adult buccal
Palatale adulto/ buccale adulto



DD.468.050
Lingual upper / lingual lower
Superiore linguale / inferiore linguale



DD.468.060
Adult buccal / child buccal
Buccale adulto/ buccale bambino



DD.468.070
Child palatal / child buccal
Palatale bambino/ buccale bambino

Intraoral photographic mirrors Specchi per foto intraorali



Autoclavabile
Autoclavabile

- Double sided front surface
- No double reflection
- Chromium coated glass
- Provides sharp images

- Bilaterali a riflessione frontale
- Evitano la doppia riflessione
- In vetro cromato
- Immagini ad elevata risoluzione



DD.470.010
Buccal
Buccale



DD.470.011
Buccal - Small
Buccale - Piccolo



DD.470.020
Lingual
Linguale

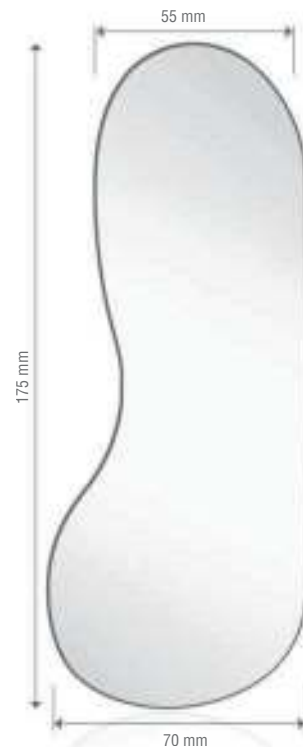

DD.470.021
Lingual - Large
Linguale - Grande



DD.470.040
Palatal - Child
Palatale - bambino



DD.470.030
Palatal - Adult
Palatale - adulto



DD.470.031
Palatal - Adult Large
Palatale - adulto grande



Photography Fotografia

Handle for intraoral photographic mirrors Manico per specchi per foto intraorali



DD.472.010
Aluminum / Alluminio
150 mm

DD.472.020
Aluminum / Alluminio
150 mm

Bendable intraoral photographic large mirrors Specchietti grandi orientabili per foto intraorali



- Bendable at any angle
- Front surface
- No double reflection
- Chromium coated glass
- Provides sharp images
- Autoclavable

- Totalmente orientabili
- Riflessione frontale
- Evitano la doppia riflessione
- In vetro cromato
- Immagini ad elevata risoluzione
- Autoclavabili

DD.471.010 Ø 38mm
DD.471.020 Ø 50mm
200 mm

Sterilization cassette for intraoral photographic mirrors 'Cassette' per sterilizzare specchi per foto intraorali



DZ.085.090
Suitable for all intraoral photographic mirrors
Adatto per tutti gli specchi per foto intraorali
180 x 90 x 20 mm

Photo cheek retractors Apribocca per fotografia



Autoclavable
Autoclavabile

DS.434.010
Falcon
150 mm

DS.434.020
Falcon
160 mm

Photo cheek and lip retractors Divaricatori per fotografia per labbra e guance



DS.435.010B
Simplex
105 mm



DS.435.000B
Simplex 1/2 CUT
105 mm
Pair (Left and Right)
Ends trimmed for easier occlusal view
Coppia (sinistra e destra)
Estremità rifilate per una visione occlusale più semplice



DS.435.020B
Simplex-Falcon
110 mm



DS.435.030B
Simplex-Falcon
170 mm
V-Shape, excellent for pulling back the cheek
V-Shape, eccellente per tirare indietro la guancia



DS.437.010B
Falcon
170 mm
Lip retractor, excellent for occlusal photos
Divaricatore per labbra, eccellente per foto occlusali



DS.435.010
Simplex
105 mm



DS.435.000
Simplex 1/2 CUT
105 mm
Pair (Left and Right)
Coppia (sinistra e destra)



DS.435.020
Simplex-Falcon
110 mm



DS.435.030
Simplex-Falcon
170 mm



DS.437.010
Falcon
170 mm

Photography Fotografia

Contrastors Strumenti di contrasto



Autoclavabile
Autoclavabile

- Gives contrast to your images and eliminates useless elements.
- Suitable for normal and digital photography.
- Black anodized aluminum.

- Utili per un efficace contrasto delle immagini e per evitare elementi inutili.
- Adatti per fotografia tradizionale e digitale.
- In alluminio anodizzato nero.



DD.475.030T
Anterior - Small
Anteriore - piccolo
245 mm

DD.475.040T
Anterior - Large
Anteriore - grande
245 mm



DD.475.050T
Anterior
Anteriore
180 mm



DD.475.060T
Posterior
Posteriore
175 mm



DD.475.070T
Occlusal - Small
Occlusale - piccolo



DD.475.080T
Occlusal - Medium
Occlusale - medio



DD.475.090T
Occlusal - Large
Occlusale - grande



**Periodontal
Parodontologia**

Periodontal Parodontologia

Gracey Curettes / Curettes di Gracey

- Ergonomic, large diameter silicone handle for better grip
- Rigid pattern, thicker tips than standard Gracey
- Manico ergonomico di grosso diametro, in silicone, per maggior grip
- Punta rigide piu' robuste delle Gracey standard



Easy
COLOR Instruments



Gracey Curettes / Curettes di Gracey

- Ergonomic, large diameter silicone handle for better grip
- Rigid pattern, thicker tips than standard Gracey
- Manico ergonomico di grosso diametro, in silicone, per maggior grip
- Punta rigide piu' robuste delle Gracey standard



Easy
COLOR Instruments



DP.999.011
standard
Set of 7 pieces / Serie da 7 pezzi



DP.156.000
rigid
Set of 7 pieces / Serie da 7 pezzi

Curettes / Curettes

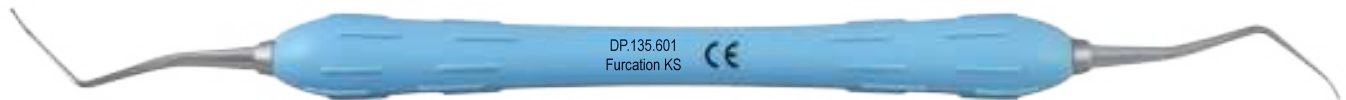

DP.135.601 Furcation KS Fig. 259-260

Scalers / Scalers (Levatartaro)



DP.763.021 Fig. 204S



DP.786.071 Hygienist Fig. 6/7

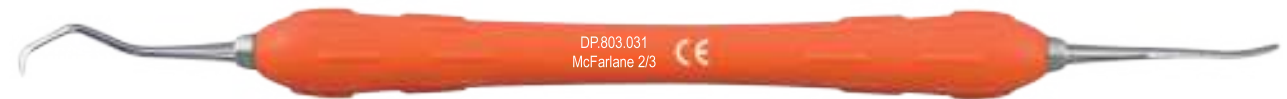

DP.803.031 McFarlane Fig. 2/3



DP.803.051 McFarlane Fig. 4/5



Periodontal Parodontologia

Gracey Curettes / Curettes di Gracey



8 mm hollow handle
Manico vuoto da 8 mm

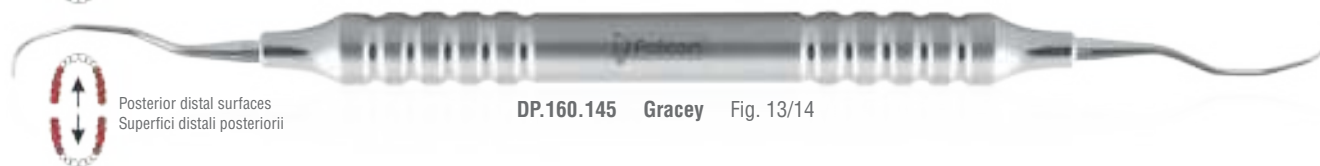
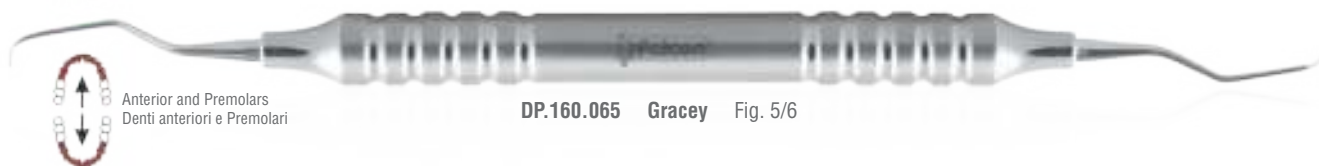
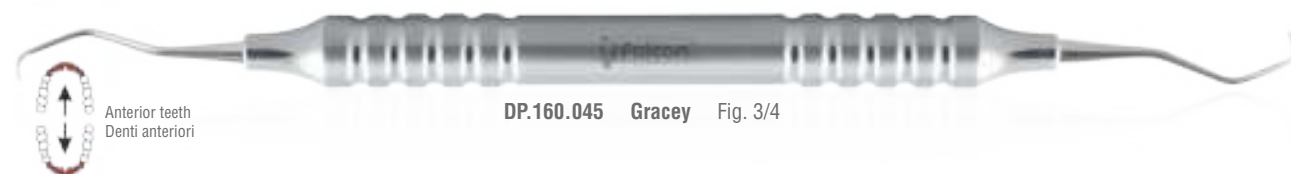
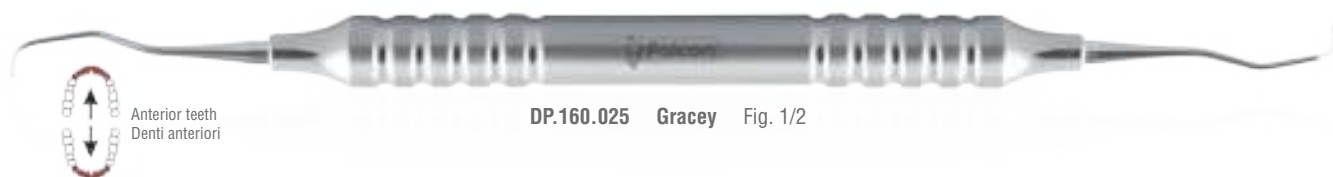

DP.999.020
Gracey set of 7 pieces
Gracey serie da 7 pezzi

Gracey Cuerttes / Curettes di Gracey

Classic Round 6 mm solid handle
Manico pieno da 6mm

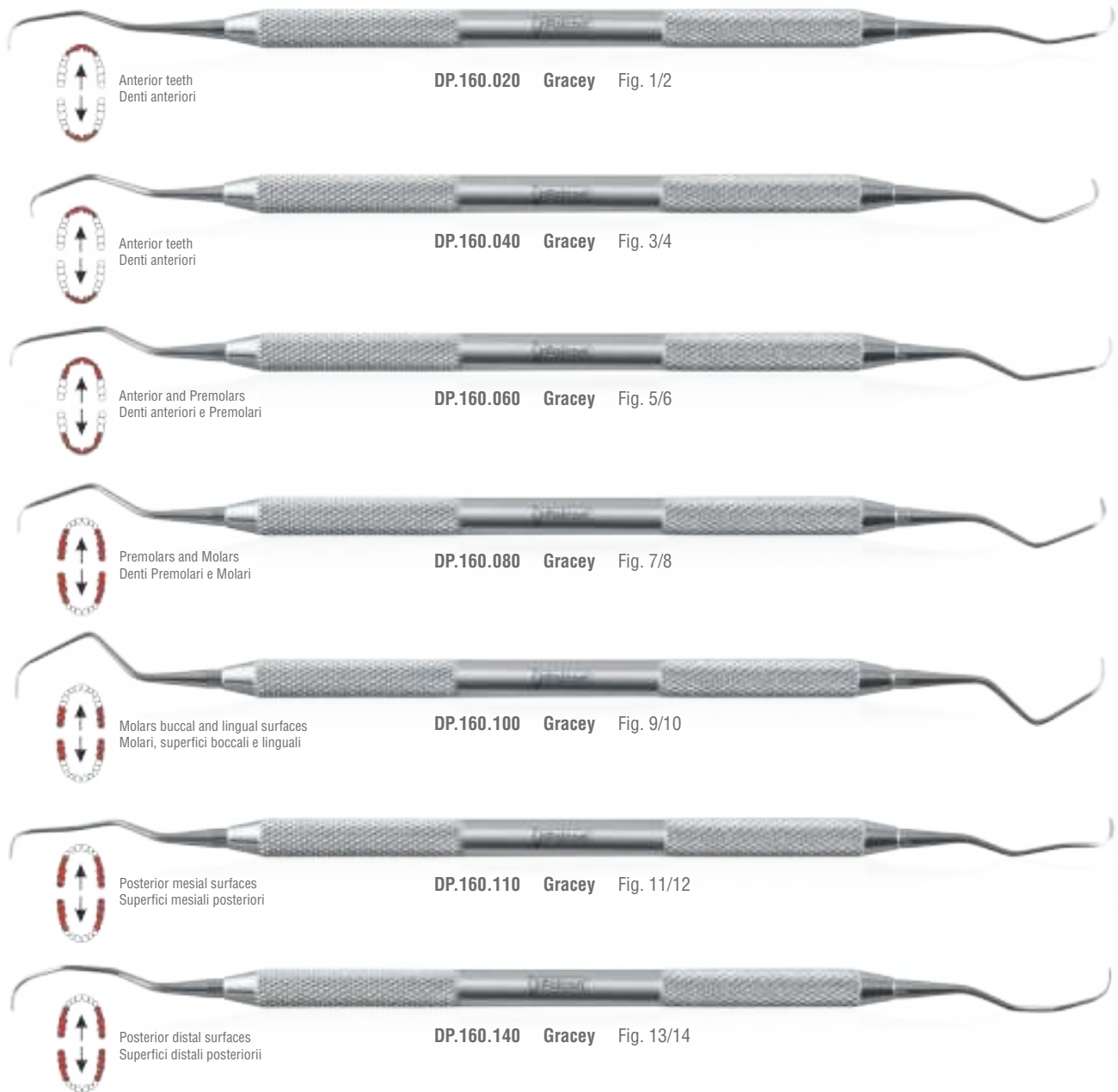

DP.999.015
Gracey set of 7 pieces
Gracey serie da 7 pezzi



Periodontal Parodontologia

Universal curettes / Curettes universali

Classic Round 6 mm solid handle
Manico pieno da 6mm

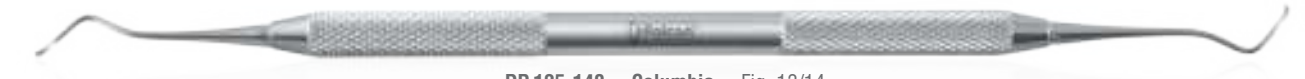

DP.125.140 Columbia Fig. 13/14

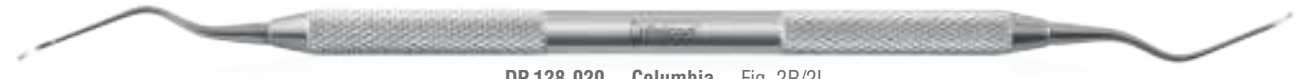

DP.128.020 Columbia Fig. 2R/2L



DP.128.040 Columbia Fig. 4R/4L

Classic-Lite 10 mm hollow handle
Manico vuoto da 10 mm



DP.125.145 Columbia Fig. 13/14



DP.128.025 Columbia Fig. 2R/2L



DP.128.045 Columbia Fig. 4R/4L

Hoe scalars / Curette sopra-gengivali a "zappa"



Goldman-Fox



Fig. 5



Fig. 6

McFarlane

with tungsten carbide tips / con punte al carburo di tungsteno



Fig. 6/7



Fig. 8/9

	Classic Round	Classic-Lite
Fig. 5	DP.365.050	DP.365.055
Fig. 6	DP.365.060	DP.365.065
Fig. 6/7	-	DP.375.075
Fig. 8/9	-	DP.375.095

Scalers / Scalers (levatartaro)

● **Classic Round** 6 mm solid handle
Manico pieno da 6mm

○ **Classic-Lite** 10 mm hollow handle
Manico vuoto da 10 mm

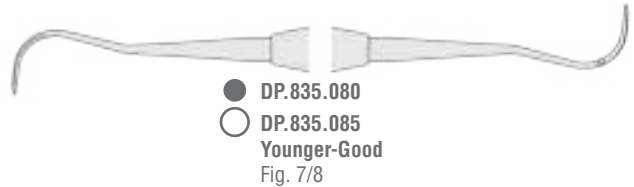
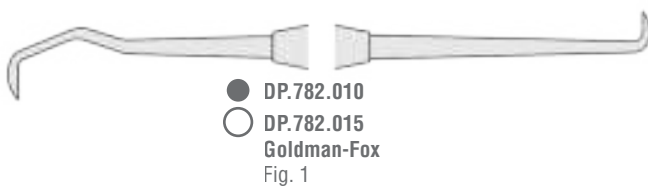
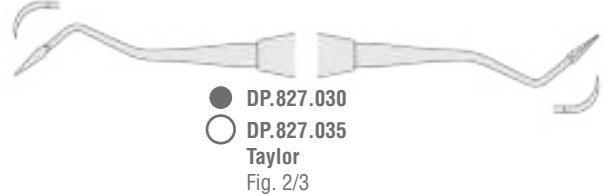
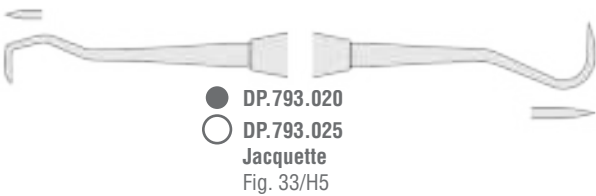
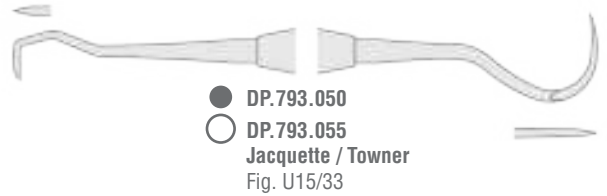
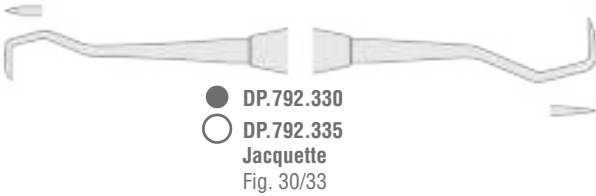
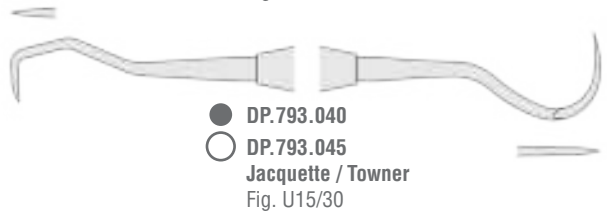
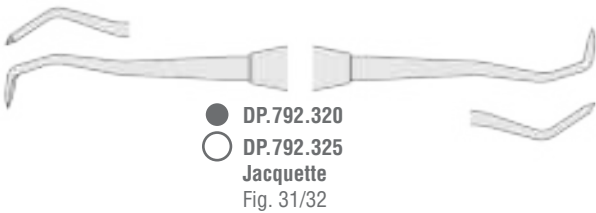
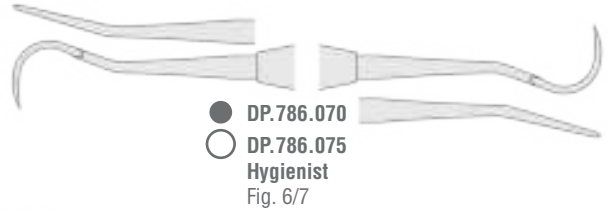
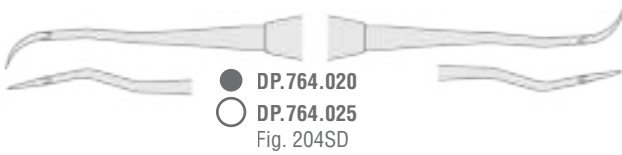
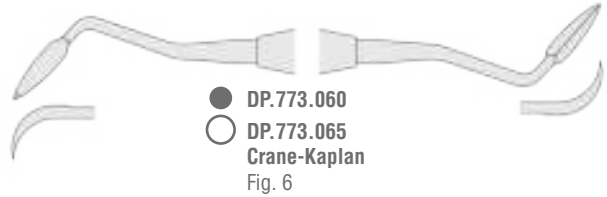
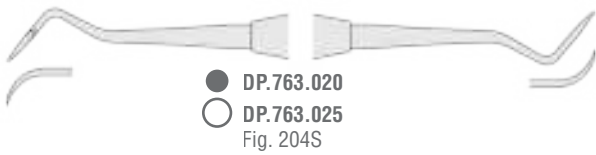
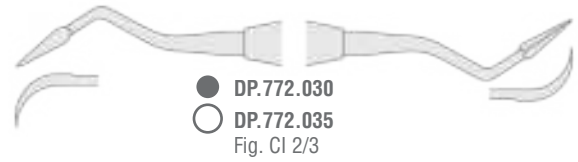
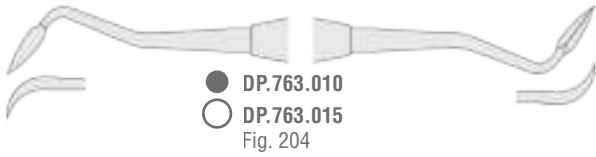

Periodontal Parodontologia

Scalers / Scalars (Levatartaro)

Classic-8 4.5 mm solid handle
Manico pieno da 4,5 mm



Hygienist

Jacquette

Standard

Standard

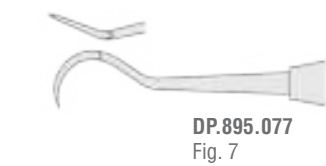
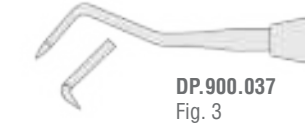
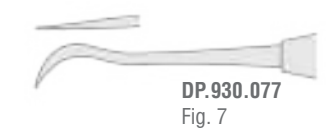
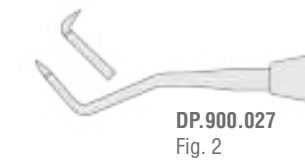
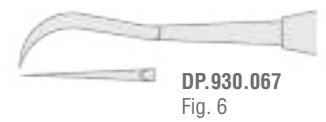
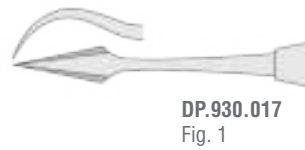

Towner

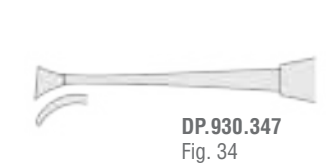
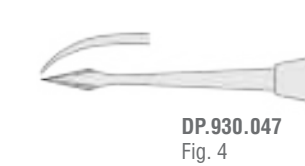
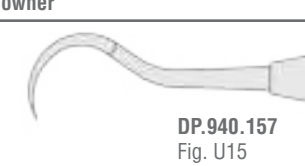

CLASSIC-LITE 10 mm hollow handle
Manico vuoto da 10 mm



Hygienist

Jacquette

Standard

Standard

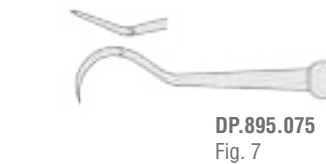
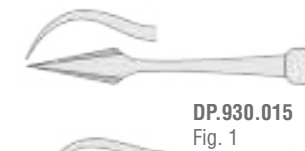

Towner

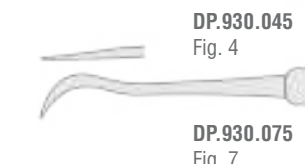
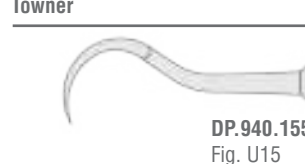



Endodontics
Endodonzia

Endodontics Endodonzia

NiTi Hedstrom files
Lime NiTi tipo Hedstrom



Pack of 6 pcs. / Conf. 6 pz.

ISO Color / No	21 mm	25 mm	28 mm
08	DR.3111.08	DR.3112.08	DR.3113.08
10	DR.3111.10	DR.3112.10	DR.3113.10
15	DR.3111.15	DR.3112.15	DR.3113.15
20	DR.3111.20	DR.3112.20	DR.3113.20
25	DR.3111.25	DR.3112.25	DR.3113.25
30	DR.3111.30	DR.3112.30	DR.3113.30
35	DR.3111.35	DR.3112.35	DR.3113.35
40	DR.3111.40	DR.3112.40	DR.3113.40
45	DR.3111.45	DR.3112.45	DR.3113.45
50	DR.3111.50	DR.3112.50	DR.3113.50
55	DR.3111.55	DR.3112.55	DR.3113.55
60	DR.3111.60	DR.3112.60	DR.3113.60
70	DR.3111.70	DR.3112.70	DR.3113.70
80	DR.3111.80	DR.3112.80	DR.3113.80
Assorted (6 pcs/pack)			
15-40	DR.3111.00	DR.3112.00	DR.3113.00
45-80	DR.3111.01	DR.3112.01	DR.3113.01

NiTi K-files
Lime NiTi tipo K



Pack of 6 pcs. / Conf. 6 pz.

ISO Color / No	21 mm	25 mm	28 mm
08	DR.3101.08	DR.3102.08	DR.3103.08
10	DR.3101.10	DR.3102.10	DR.3103.10
15	DR.3101.15	DR.3102.15	DR.3103.15
20	DR.3101.20	DR.3102.20	DR.3103.20
25	DR.3101.25	DR.3102.25	DR.3103.25
30	DR.3101.30	DR.3102.30	DR.3103.30
35	DR.3101.35	DR.3102.35	DR.3103.35
40	DR.3101.40	DR.3102.40	DR.3103.40
45	DR.3101.45	DR.3102.45	DR.3103.45
50	DR.3101.50	DR.3102.50	DR.3103.50
55	DR.3101.55	DR.3102.55	DR.3103.55
60	DR.3101.60	DR.3102.60	DR.3103.60
70	DR.3101.70	DR.3102.70	DR.3103.70
80	DR.3101.80	DR.3102.80	DR.3103.80
Assorted (6 pcs/pack)			
15-40	DR.3101.00	DR.3102.00	DR.3103.00
45-80	DR.3101.01	DR.3102.01	DR.3103.01

Stainless steel Hedstrom files
Lime in acciaio inox tipo Hedstrom



Pack of 6 pcs. / Conf. 6 pz.

ISO Color / No	21 mm	25 mm	28 mm
10	DR.3161.10	DR.3162.10	DR.3163.10
15	DR.3161.15	DR.3162.15	DR.3163.15
20	DR.3161.20	DR.3162.20	DR.3163.20
25	DR.3161.25	DR.3162.25	DR.3163.25
30	DR.3161.30	DR.3162.30	DR.3163.30
35	DR.3161.35	DR.3162.35	DR.3163.35
40	DR.3161.40	DR.3162.40	DR.3163.40
45	DR.3161.45	DR.3162.45	DR.3163.45
50	DR.3161.50	DR.3162.50	DR.3163.50
55	DR.3161.55	DR.3162.55	DR.3163.55
60	DR.3161.60	DR.3162.60	DR.3163.60
70	DR.3161.70	DR.3162.70	DR.3163.70
80	DR.3161.80	DR.3162.80	DR.3163.80
Assorted (6 pcs/pack)			
15-40	DR.3161.00	DR.3162.00	DR.3163.00
45-80	DR.3161.01	DR.3162.01	DR.3163.01

Stainless steel K-files
Lime in acciaio inox tipo K



Pack of 6 pcs. / Conf. 6 pz.

ISO Color / No	21 mm	25 mm	28 mm
10	DR.3151.10	DR.3152.10	DR.3153.10
15	DR.3151.15	DR.3152.15	DR.3153.15
20	DR.3151.20	DR.3152.20	DR.3153.20
25	DR.3151.25	DR.3152.25	DR.3153.25
30	DR.3151.30	DR.3152.30	DR.3153.30
35	DR.3151.35	DR.3152.35	DR.3153.35
40	DR.3151.40	DR.3152.40	DR.3153.40
45	DR.3151.45	DR.3152.45	DR.3153.45
50	DR.3151.50	DR.3152.50	DR.3153.50
55	DR.3151.55	DR.3152.55	DR.3153.55
60	DR.3151.60	DR.3152.60	DR.3153.60
70	DR.3151.70	DR.3152.70	DR.3153.70
80	DR.3151.80	DR.3152.80	DR.3153.80
Assorted (6 pcs/pack)			
15-40	DR.3151.00	DR.3152.00	DR.3153.00
45-80	DR.3151.01	DR.3152.01	DR.3153.01



Niti pluggers
NiTi pluggers



Pack of 6 pcs. / Conf. 6 pz.

ISO Color / No	21 mm	25 mm	28 mm
15	DR.3131.15	DR.3132.15	DR.3133.15
20	DR.3131.20	DR.3132.20	DR.3133.20
25	DR.3131.25	DR.3132.25	DR.3133.25
30	DR.3131.30	DR.3132.30	DR.3133.30
35	DR.3131.35	DR.3132.35	DR.3133.35
40	DR.3131.40	DR.3132.40	DR.3133.40
45	DR.3131.45	DR.3132.45	DR.3133.45
Assorted (6 pcs/pack)			
15-40	DR.3131.00	DR.3132.00	DR.3133.00



NiTi spreaders
NiTi spreaders

Pack of 6 pcs. / Conf. 6 pz.

ISO Color / No	21 mm	25 mm	28 mm
15	DR.3141.15	DR.3142.15	DR.3143.15
20	DR.3141.20	DR.3142.20	DR.3143.20
25	DR.3141.25	DR.3142.25	DR.3143.25
30	DR.3141.30	DR.3142.30	DR.3143.30
35	DR.3141.35	DR.3142.35	DR.3143.35
40	DR.3141.40	DR.3142.40	DR.3143.40
45	DR.3141.45	DR.3142.45	DR.3143.45
Assorted (6 pcs/pack)			
15-40	DR.3141.00	DR.3142.00	DR.3143.00



NiTi reamers
NiTi reamers

Pack of 6 pcs. / Conf. 6 pz.

ISO Color / No	21 mm	25 mm	28 mm
10	DR.3121.10	DR.3122.10	DR.3123.10
15	DR.3121.15	DR.3122.15	DR.3123.15
20	DR.3121.20	DR.3122.20	DR.3123.20
25	DR.3121.25	DR.3122.25	DR.3123.25
30	DR.3121.30	DR.3122.30	DR.3123.30
35	DR.3121.35	DR.3122.35	DR.3123.35
40	DR.3121.40	DR.3122.40	DR.3123.40
45	DR.3121.45	DR.3122.45	DR.3123.45
50	DR.3121.50	DR.3122.50	DR.3123.50
55	DR.3121.55	DR.3122.55	DR.3123.55
60	DR.3121.60	DR.3122.60	DR.3123.60
70	DR.3121.70	DR.3122.70	DR.3123.70
80	DR.3121.80	DR.3122.80	DR.3123.80
Assorted (6 pcs/pack)			
15-40	DR.3121.00	DR.3122.00	DR.3123.00
45-80	DR.3121.01	DR.3122.01	DR.3123.01



Stainless steel reamers
Reamers in acciaio inox

Pack of 6 pcs. / Conf. 6 pz.

ISO Color / No	21 mm	25 mm	28 mm
10	DR.3171.10	DR.3172.10	DR.3173.10
15	DR.3171.15	DR.3172.15	DR.3173.15
20	DR.3171.20	DR.3172.20	DR.3173.20
25	DR.3171.25	DR.3172.25	DR.3173.25
30	DR.3171.30	DR.3172.30	DR.3173.30
35	DR.3171.35	DR.3172.35	DR.3173.35
40	DR.3171.40	DR.3172.40	DR.3173.40
45	DR.3171.45	DR.3172.45	DR.3173.45
50	DR.3171.50	DR.3172.50	DR.3173.50
55	DR.3171.55	DR.3172.55	DR.3173.55
60	DR.3171.60	DR.3172.60	DR.3173.60
70	DR.3171.70	DR.3172.70	DR.3173.70
80	DR.3171.80	DR.3172.80	DR.3173.80
Assorted (6 pcs/pack)			
15-40	DR.3171.00	DR.3172.00	DR.3173.00
45-80	DR.3171.01	DR.3172.01	DR.3173.01

Endodontics Endodonzia

Endodontic explorers / Sonde per canali



Easy **COLOR** Instruments



DR.584.281
Fig. 27/28



SOFT LINE INSTRUMENTS
soft steel core grip



DR.584.014
Fig. 1
Cream / Crema



DR.584.164
Fig. DG 16
Stewart
Cream / Crema

Classic Round 6 mm solid handle
Manico pieno da 6mm



DR.584.161
Fig. DG 16

DR.584.171
Fig. DG 16/17

DR.584.231
Fig. DG 16/23

Classic Round 6 mm solid handle
Manico pieno da 6mm

Endodontic excavators / Escavatori endodontici



DR.577.320
Fig. 32 L



DR.577.310
Fig. 31 L



DR.577.330
Fig. 33L

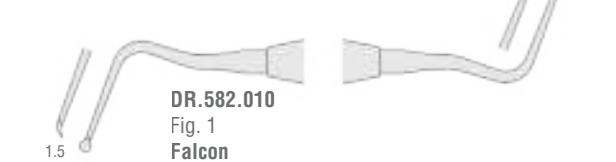

DR.582.010
Fig. 1
Falcon

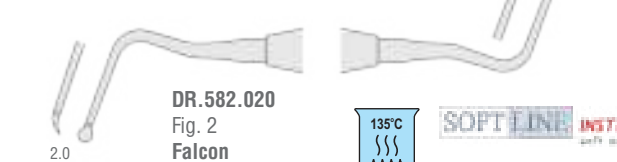

DR.582.020
Fig. 2
Falcon



SOFT LINE INSTRUMENTS
soft steel core grip



DR.582.014
Fig. 1
Falcon
Blue-Orange / Blu-Arancione



DR.582.024
Fig. 2
Falcon
Blue-Orange / Blu-Arancione

Hand pluggers / Otturatori per canali

Classic Round 6 mm solid handle
Manico pieno da 6mm



DR.594.013
Fig. 1
Falcon

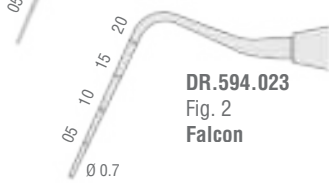

DR.594.023
Fig. 2
Falcon

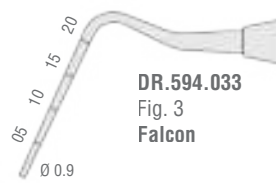

DR.594.033
Fig. 3
Falcon

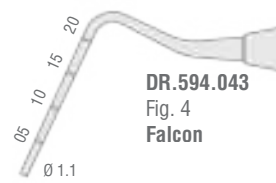

DR.594.043
Fig. 4
Falcon



DR.596.011
Fig. 1
Luks



DR.596.021
Fig. 2
Luks



DR.596.031
Fig. 3
Luks



DR.596.041
Fig. 4
Luks



Autoclavabile
Autoclavabile

SOFT LINE INSTRUMENTS
soft and sure grip

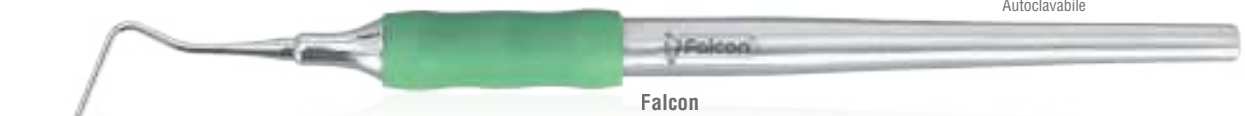

Falcon

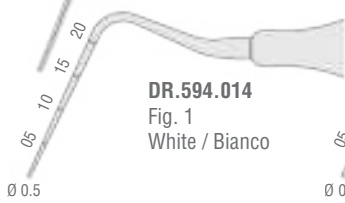

DR.594.014
Fig. 1
White / Bianco

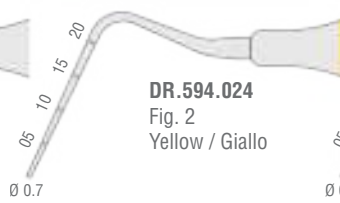

DR.594.024
Fig. 2
Yellow / Giallo

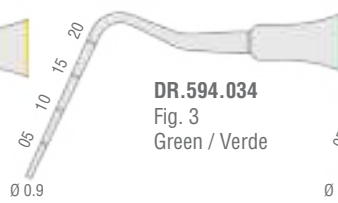

DR.594.034
Fig. 3
Green / Verde

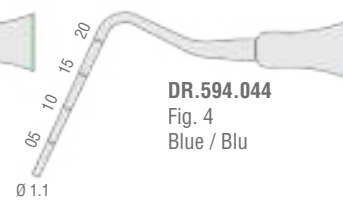

DR.594.044
Fig. 4
Blue / Blu



Autoclavabile
Autoclavabile

Easy COLOR INSTRUMENTS



DR.591.421
Fig. 41-42



Autoclavabile
Autoclavabile

SOFT LINE INSTRUMENTS
soft and sure grip

NiTi hand pluggers / Otturatori per canali NiTi



DR.590.014
Fig. 1
Falcon
Black / Nero



Ø 0.7



DR.590.024
Fig. 2
Falcon
Black / Nero

Ø 1.3

Endodontics Endodonzia

Hand spreaders / Spreader per endodonzia

Classic Round 6 mm solid handle
Manico pieno da 6mm

DR.602.033
Fig. 3
Falcon

DR.602.013
Fig. 1

DR.602.023
Fig. 2

DR.602.043
Fig. 4

DR.602.053
Fig. 5

DR.602.063
Fig. 6

DR.602.073
Fig. 7



Autoclavable
Autoclavabile

SOFT LINE INSTRUMENTS
soft steel extra grip

Falcon

DR.602.014
Fig. 1
White / Bianco

DR.602.024
Fig. 2
Yellow / Giallo

DR.602.034
Fig. 3
Green / Verde

DR.602.044
Fig. 4
Blue / Blu

Micro endodontic pluggers/burnishers / Micro otturatori/brunitori per endodonzia

DR.040.014
Fig. 1
Blue / Blu

DR.040.024
Fig. 2
Blue / Blu

DR.041.004
Fig. 0
White-Cream / Bianco-Crema

DR.041.014
Fig. 1
White-Peach / Bianco-Pesca

DR.045.004
Fig. 0
White-Cream / Bianco-Crema

DR.046.004
Fig. 0
Left / Sinistro
White-Cream / Bianco-Crema

DR.047.004
Fig. 0
Right / Destro
White-Peach / Bianco-Pesca

Perforation repair instruments / Strumenti per cure canalari



Autoclavable
Autoclavabile

SOFT LINE INSTRUMENTS
soft and sure grip

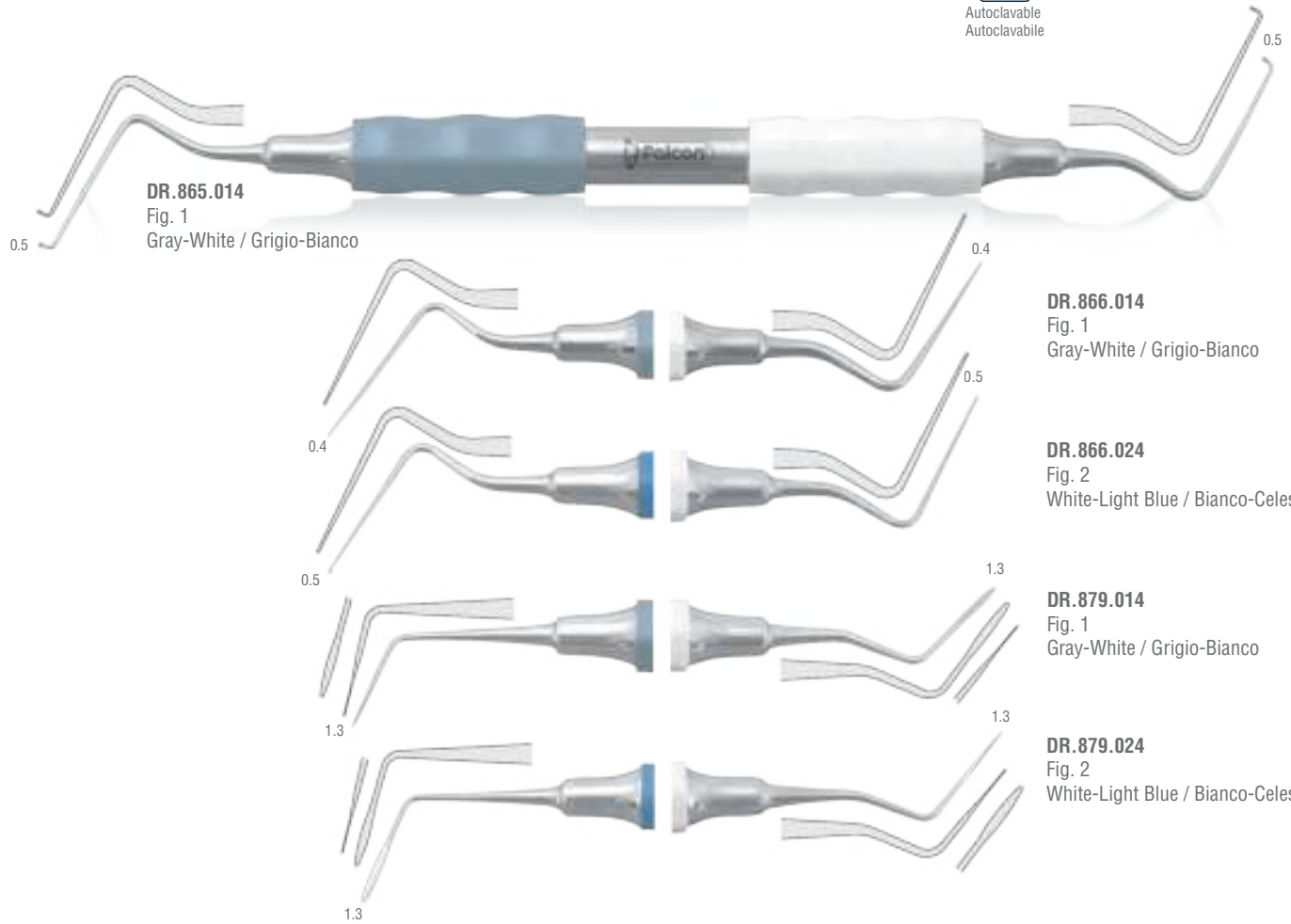

DR.865.014
Fig. 1
Gray-White / Grigio-Bianco

DR.866.014
Fig. 1
Gray-White / Grigio-Bianco

DR.866.024
Fig. 2
White-Light Blue / Bianco-Celeste

DR.879.014
Fig. 1
Gray-White / Grigio-Bianco

DR.879.024
Fig. 2
White-Light Blue / Bianco-Celeste

Endodontic retractors / Divaricatori per endonzia



DS.488.014
Fig. 1
Blue / Blu

DS.488.024
Fig. 2
Red / Rosso

DS.488.034
Fig. 3
Green / Verde



Endodontics Endodonzia

Endodontic curettes / Curette per endodonzia



Autoclavable
Autoclavabile

SOFT LINE INSTRUMENTS
soft and sure grip



DS.126.044
Fig. 2/4
Molt
Red-Pink / Rosso-Rosa

DS.146.014
Fig. 1
Ruddle
Left / Sinistro
Red-Peach / Rosso-Pesca

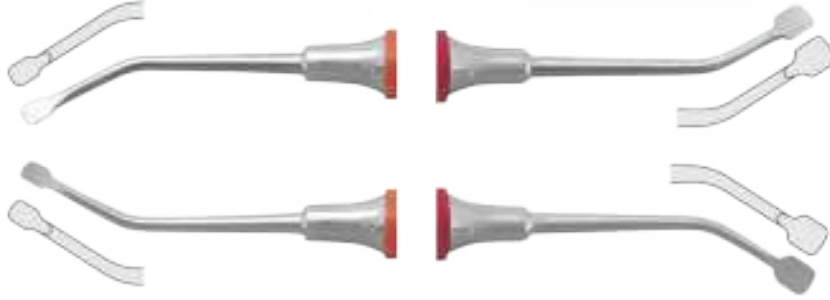

DS.146.024
Fig. 2
Ruddle
Right / Destro
Red-Orange / Rosso-Arancione

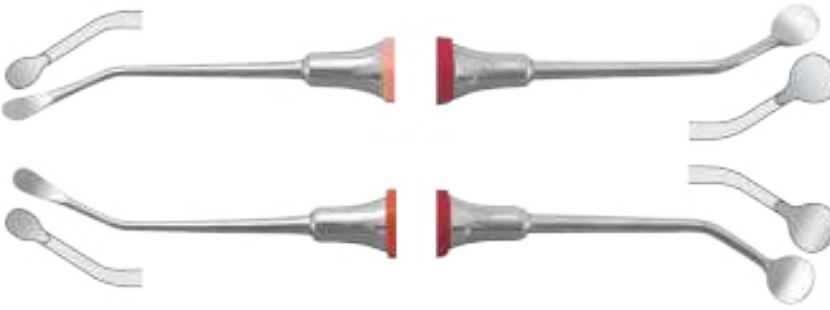

DS.147.014
Fig. 1
Ruddle
Left / Sinistro
Red-Peach / Rosso-Pesca

DS.147.024
Fig. 2
Ruddle
Right / Destro
Red-Orange / Rosso-Arancione

Endodontic forceps / Pinze per endodonzia

Micro forceps for removing broken files
Micro pinze per asportare frammenti di lime

Silver points and broken files removing forceps
Pinze per la rimozione di corpi (lime rotte, punti in argento)



DR.587.030
Straight / Dritto

DR.587.040
Upward / Piegato in alto

DR.587.050
Left / Piegato a sinistra

DR.587.060
Right / Piegato a destra

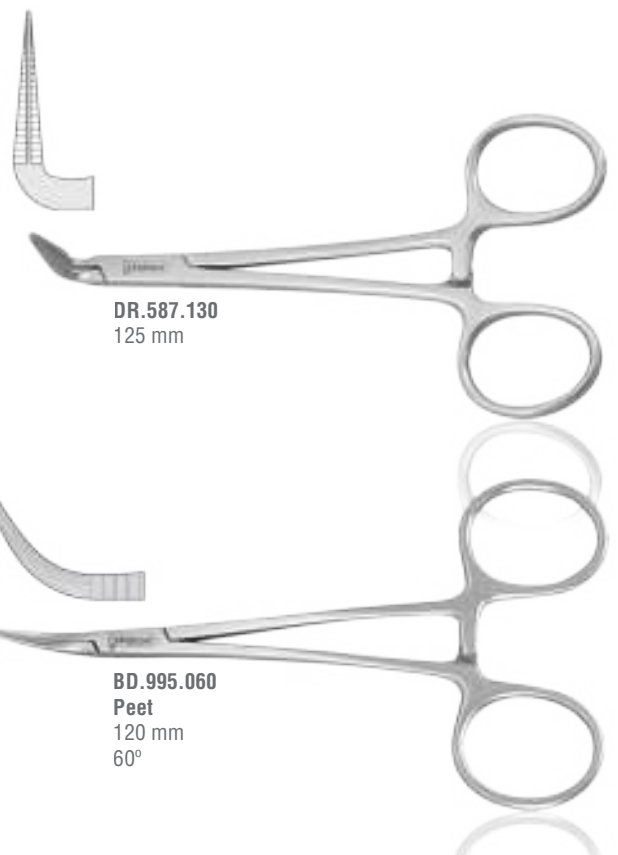

DR.587.130
125 mm

BD.995.060
Peet
120 mm
60°

Endodontic tweezers / Endo pinzetta



DR.586.020
150 mm

Endodontic instruments holder / Porta strumenti canalari



DR.2999.00

Aluminum endodontic instruments cleaner, closed
Pulitore per strumenti canalari in alluminio, fondo chiuso



DZ.572.010
Silver / Argento



DZ.572.050
Spare sponges (pack of 50 pieces)
Spugnetta di ricambio (conf. 50 pezzi)
Ø 55 mm x 5 mm



DZ.572.100
Spare sponges (pack of 50 pieces)
Spugnetta di ricambio (conf. 50 pezzi)
Ø 55 mm x 10 mm

Endometers
Misuratore per strumenti canalari



DZ.573.000
Endo-Ruler Ultima

Contains:
1 Endo-Ruler (laser etched)
10 Disposable medicament cups
3 Disposable foams

Contiene:
1 righello misuratore (stampato a laser)
10 coppette monouso per medicamento
3 spugnette monouso

Spares / Ricambi
DZ.573.010
Disposable medicament cups (pack of 50)
Coppette monouso per medicamento (Conf. 50 pz.)

DZ.573.020
Disposable foams (pack of 10)
Spugnette monouso (Conf. 10 pz.)

Aluminum Endometer
Misuratore per strumenti canalari in Alluminio



DZ.574.010



DZ.575.010
Laser etched / Stampato a laser

Endodontics Endodonzia

Aluminum endodontic tray with cover
Vassoio endodontico in alluminio con coperchio



DZ.555.000
257x116x16mm

Stainless steel endodontic/implant tray with cover
Vassoio per strumenti canalari e per implantologia in acciaio inox con coperchio



DZ.556.000
205 x 100 x 25 mm

Boxes for Endodontic Instruments
Contenitori per strumenti canalari



DZ.565.010
Silver / Argento



DZ.565.020
Green / Verde



DZ.565.030
Golden / Oro



DZ.565.040
Blue / Blu



DZ.565.050
Red / Rosso



**Restorative
Conservativa**

Restorative Conservativa

Compo-Art

Instruments for aesthetic restorations
Strumenti per conservativa estetica



DR.400.011
Super flexible spatula for application and modeling of composite material
Spatola super flessibile per applicare e modellare il composito



DR.400.021
Super flexible twisted spatula for application and modeling of composite in hard to reach areas
Spatola super flessibile per applicare e modellare il composito in aree di difficile accesso



DR.400.031
Round tipped condenser for modeling of composite
Condensatore con punte arrotondate per modellare il composito



DR.400.041
Super flexible spatula for application and modeling of composite material
Spatola super flessibile per applicare e modellare il composito



Compo-Art

Instruments for aesthetic restorations
Strumenti per conservativa estetica



DR.400.051

Sharp pointed instrument to place fissures, grooves and pits creating the ideal occlusal anatomy
Strumento con punte affusolate per trattare fessure, scanalature o piccole cavità e ricreare l'occlusione anatomica dentale



DR.400.061

Sharp instrument for the removal of excess composite and bonding material
Strumento con punte affilate per rimuovere il materiale composito o adesivo in eccesso



DR.400.071

Instrument to determine the vertical and horizontal thickness of composite layers on the anterior restorations
Strumento per rilevare lo spessore orizzontale e verticale degli strati di composito nella conservativa anteriore



DR.400.081

Instrument to determine the vertical and horizontal thickness of composite layers on the posterior restorations
Strumento per rilevare lo spessore orizzontale e verticale degli strati di composito nella conservativa posteriore



Restorative Conservativa

Compo-fill Instruments



Easy
COLOR Instruments

Key features

- Ultra Light weight
- Non-stick tips
- TIN coated

Caratteristiche:

- Ultraleggeri
- Punta antiaderenti
- Rivestimento in nitruro di titanio

Pluggers / Otturatori

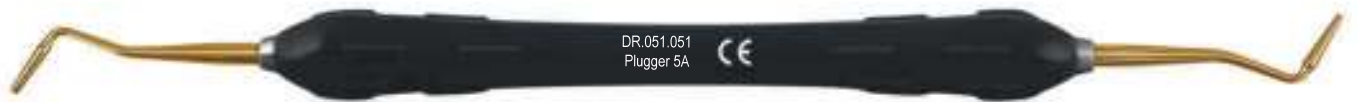

DR.051.051
Plugger 5A

DR.051.051
Fig. 5A

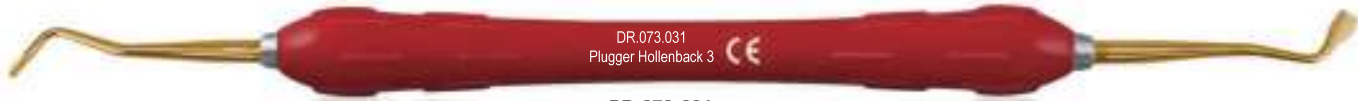

DR.073.031
Plugger Hollenback 3

DR.073.031
Fig. 3
Hollenback



DR.091.011
Plugger Super 1

DR.091.011
Fig. 1
Super



DR.092.011
Plugger Tanner OT

DR.092.001
Fig. OT
Tanner

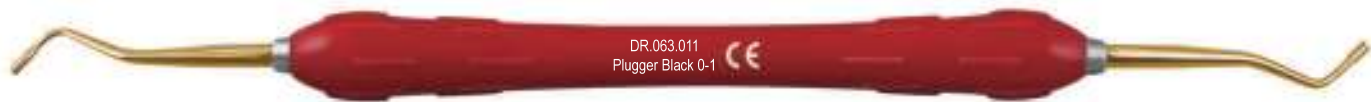

DR.063.011
Plugger Black 0-1

DR.063.011
Fig. 0/1
Black



DR.063.021
Plugger Black 1-2

DR.063.021
Fig. 1/2
Black

Compo-fill
Instruments



Easy
COLOR Instruments

Burnishers / Brunitori



DR.111.211
Acron/Wescott 21B CE

DR.111.211
Fig. 21B
Acorn/ Wescott

DR.121.011
Contract Former 1 CE

DR.121.011
Fig. 1
Contact Former

DR.121.021
Contract Former 2 CE

DR.121.021
Fig. 2
Contact Former

DR.139.021
Ladmore 2 CE

DR.139.021
Fig. 2
Ladmore

DR.139.031
Ladmore 3 CE

DR.139.031
Fig. 3
Ladmore

DR.148.041
White 27-29 CE

DR.148.041
Fig. 27/29
White

DR.100.011
Burnisher 1 CE

DR.100.011
Fig. 1

DR.101.011
Burnisher 1L CE

DR.101.011
Fig. 1L

DR.135.551
Burnisher 155 CE

DR.135.551
Fig. 155



Restorative Conservativa

Compo-fill
Instruments



Easy
COLOR Instruments

Filling Instruments / Strumenti per otturazioni



DR.426.561
Fig. 156 (A6)

DR.426.561
Fig. 156(A6)

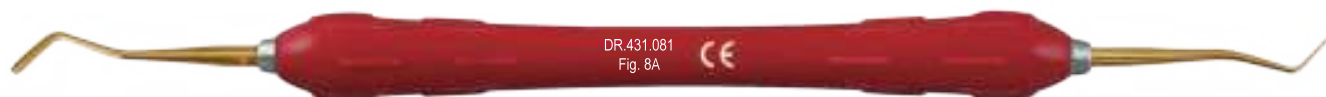

DR.431.081
Fig. 8A

DR.431.081
Fig. 8A



DR.445.011
Boghosian 1

DR.445.011
Fig. 1
Boghosian



DR.445.021
Boghosian 2

DR.445.021
Fig. 2
Boghosian



DR.451.011
Falcon 1

DR.451.011
Fig. 1
Falcon



DR.451.021
Falcon 2

DR.451.021
Fig. 2
Falcon



DR.457.011
Goldstein 1

DR.457.011
Fig. 1
Goldstein

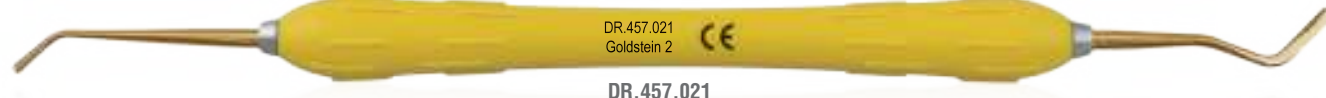

DR.457.021
Goldstein 2

DR.457.021
Fig. 2
Goldstein

Compo-fill
Instruments

Filling Instruments / Strumenti per otturazioni



Easy
COLOR Instruments



DR.457.031
Goldstein 3
CE
DR.457.031
Fig. 3
Goldstein



DR.457.041
Goldstein 4
CE
DR.457.041
Fig. 4
Goldstein



DR.458.011
Goldstein-Mini 1
CE
DR.458.011
Fig. 1
Goldstein-Mini

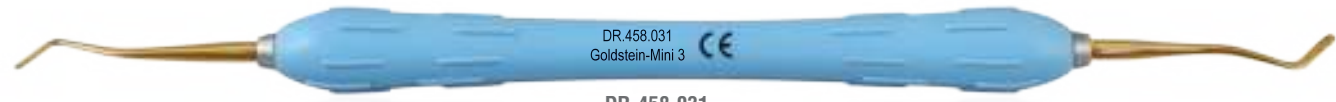

DR.458.031
Goldstein-Mini 3
CE
DR.458.031
Fig. 3
Goldstein-Mini



DR.458.041
Goldstein-Mini 4
CE
DR.458.041
Fig. 4
Goldstein-Mini



DR.459.011
Goldstein-Micro 1
CE
DR.459.011
Fig. 1
Goldstein-Micro



DR.460.051
Gregg 4-5
CE
DR.460.051
Fig. 4/5
Gregg

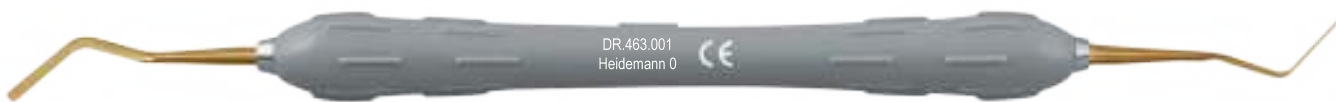

DR.463.001
Heidemann 0
CE
DR.463.001
Fig. 0
Heidemann



Restorative Conservativa

Compo-fill
Instruments



Easy
COLOR Instruments

Filling Instruments / Strumenti per otturazioni



DR.463.011
Heidemann 1 CE

DR.463.011
Fig. 1
Heidemann

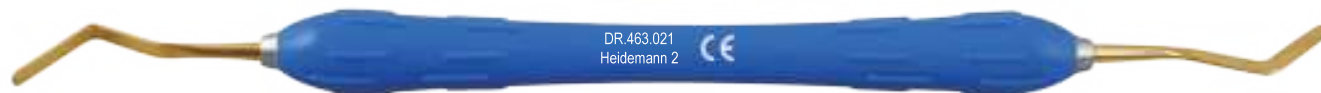

DR.463.021
Heidemann 2 CE

DR.463.021
Fig. 2
Heidemann



DR.513.031
W3 CE

DR.513.031
Fig. W3



DR.425.011
Fig. 1 CE

DR.425.011
Fig. 1

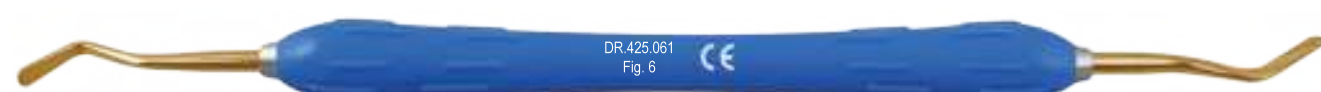

DR.425.061
Fig. 6 CE

DR.425.061
Fig. 6



DR.426.781
Fig. 178 CE

DR.426.781
Fig. 178

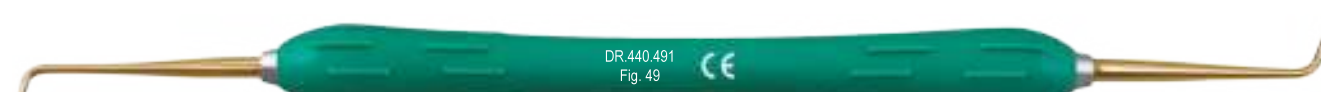

DR.440.491
Fig. 49 CE

DR.440.491
Fig. 49

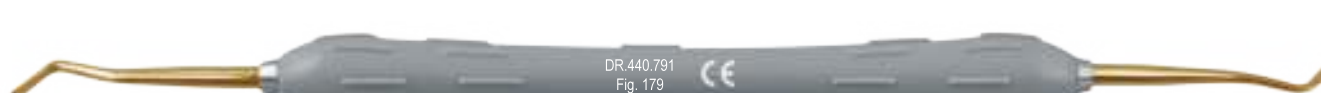

DR.440.791
Fig. 179 CE

DR.440.791
Fig. 179

Filling Instruments / Strumenti per otturazioni



Easy
COLOR Instruments

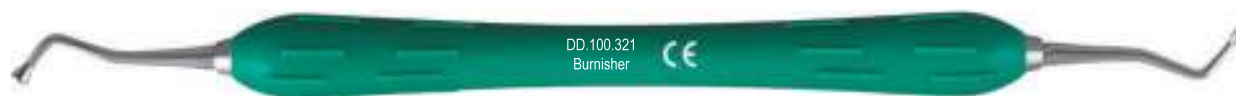

DD.100.321
Burnisher

DR.100.321
Fig. 31/32

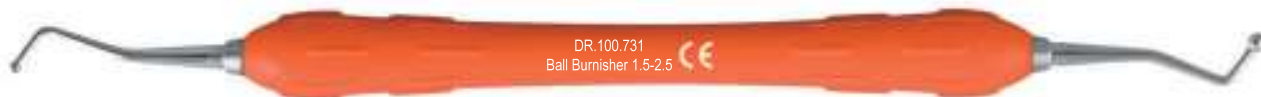

DR.100.731
Ball Burnisher 1.5-2.5

DR.100.731
Fig. 471/473



DR.121.111
Packer-Modeller 10

DR.121.111
Fig. 482/483

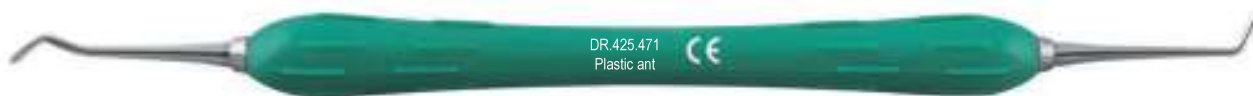

DR.425.471
Plastic ant

DR.425.471
Fig. 43/47



DR.870.011
Carrier

DR.870.011
Fig. 29H/30H

Carvers / Strumenti per modellare

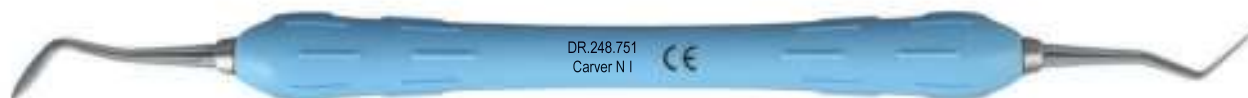

DR.248.751
Carver N I

DR.248.751
Fig. N 1
Nyström I

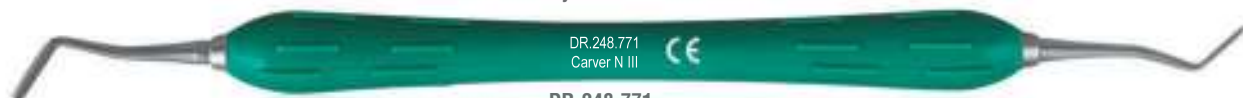

DR.248.771
Carver N III

DR.248.771
Fig. N 3
Nyström III

Gingival Margin Trimmers / Trimmer per il margine gengivale



DR.370.011
GM Trim distal 1.2

DR.370.011
Fig. 121/122



DR.370.021
GM Trim mesial 1.2

DR.370.021
Fig. 125/126



Restorative Conservativa

Excavators / Escavatori



Easy
COLOR Instruments



Amalgam carriers / Spingi amalgama

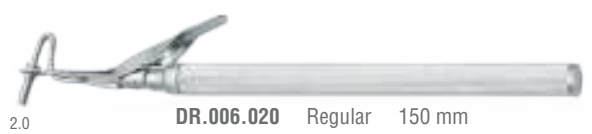

For micro filling / Per micro otturazioni



Amalgam well / Mortaio per amalgama



Restorative Conservativa

Amalgam Pluggers/Condensers / Otturatori/condensatori per amalgama

Classic-8 6 mm solid handle
Manico pieno da 6mm



Standard

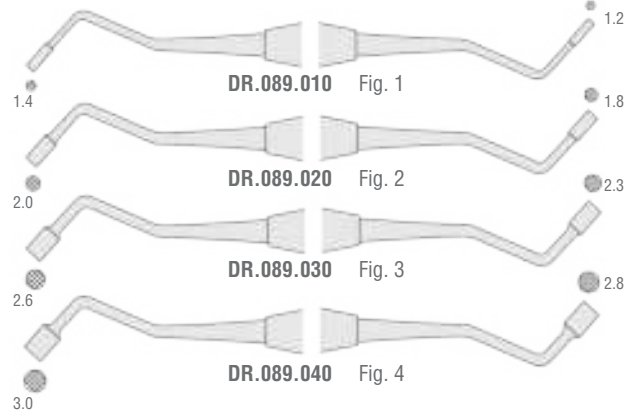
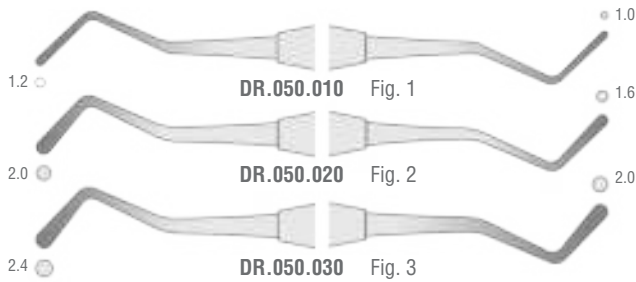

Falcon

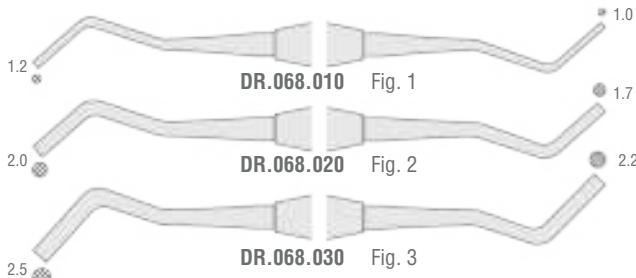

Standard

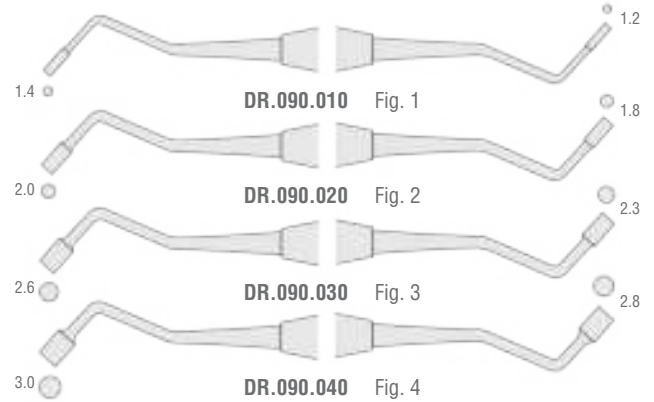

Falcon

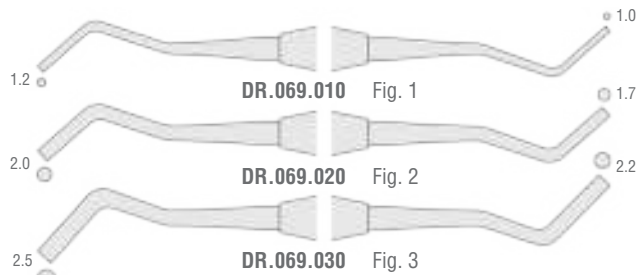

Markley

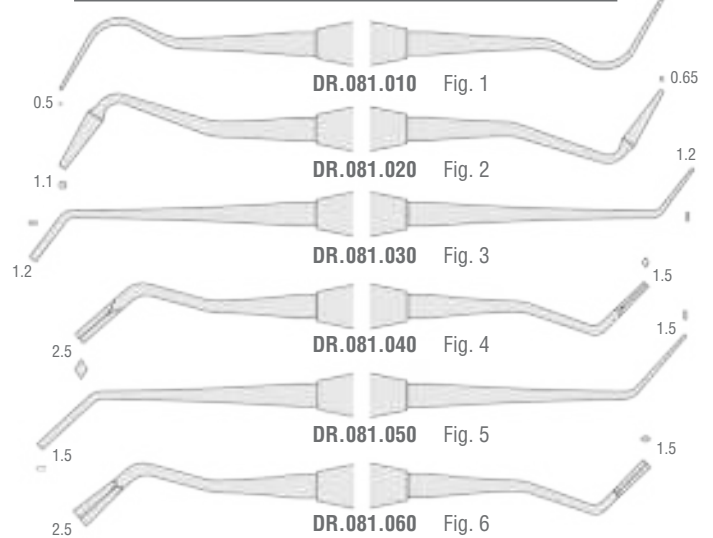

Wards

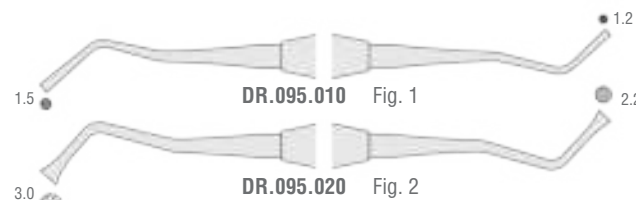

Classic-8

5.5 mm solid handle
Manico pieno da 5,5 mm
Black



Burnishers / Brunitori

Classic Found
6 mm solid handle
Manico pieno da 6mm

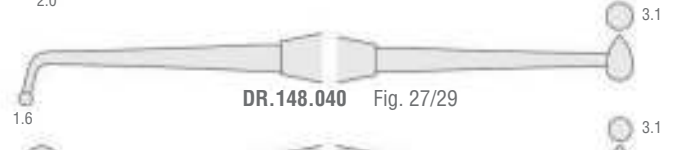
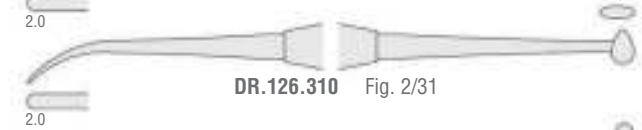
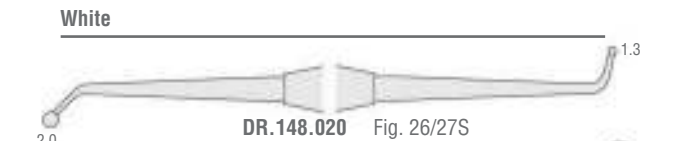
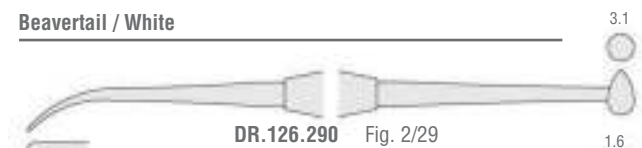
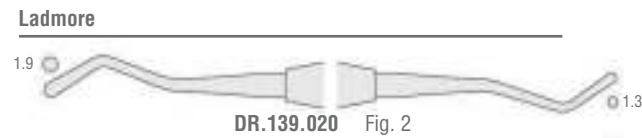
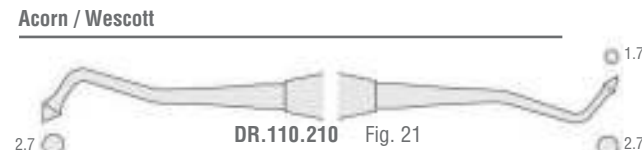
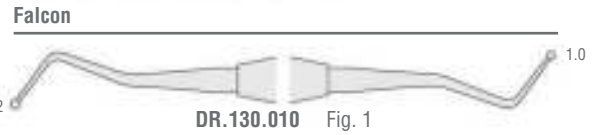
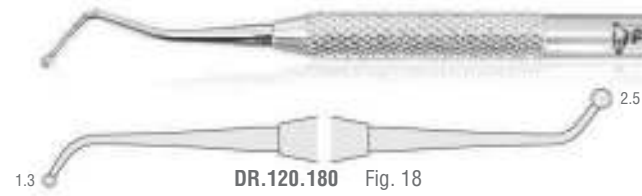

Classic-Lite
8.0 mm hollow handle
Manico vuoto da 8,0 mm

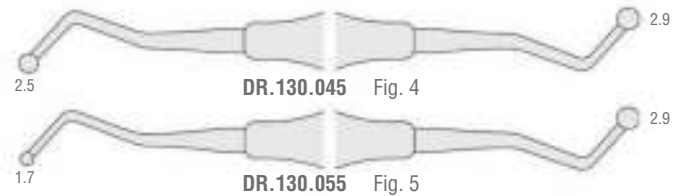
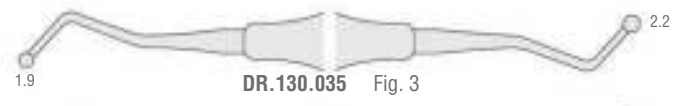
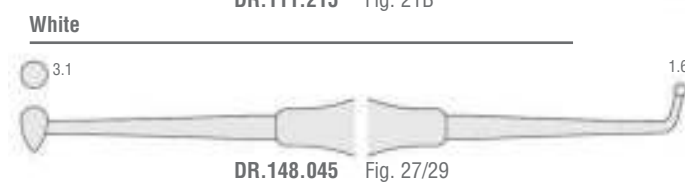
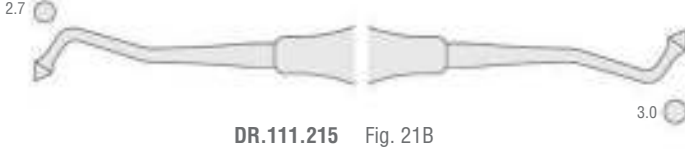
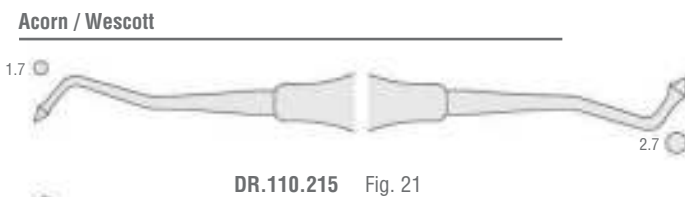

Restorative Conservativa

Burnishers / Brunitori

Classic-8 5.5 mm solid handle
Manico pieno da 5,5 mm

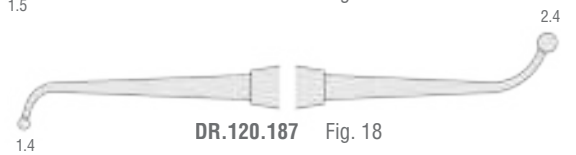
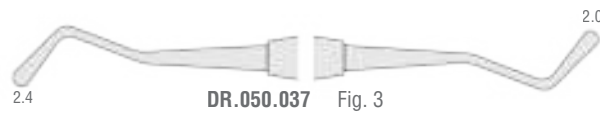
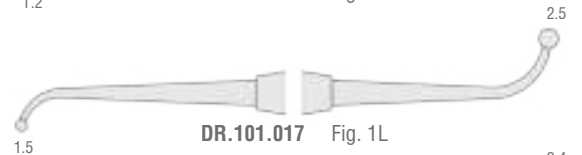
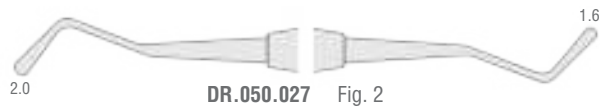
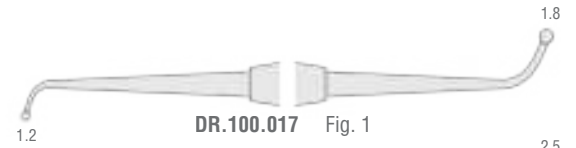
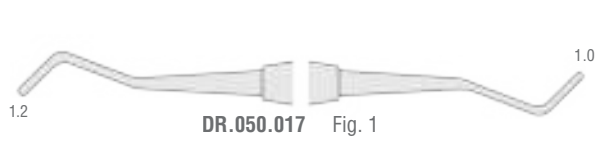

Applicators for calcium hydroxide / Applicatori per sottofondo

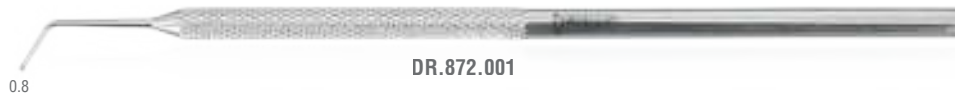

Applicator for medicaments / Applicatore per medicamenti



Composite/Plastic Filling Instruments / Strumenti per otturazioni plastiche

Classic Round
6 mm solid handle
Manico pieno da 6mm

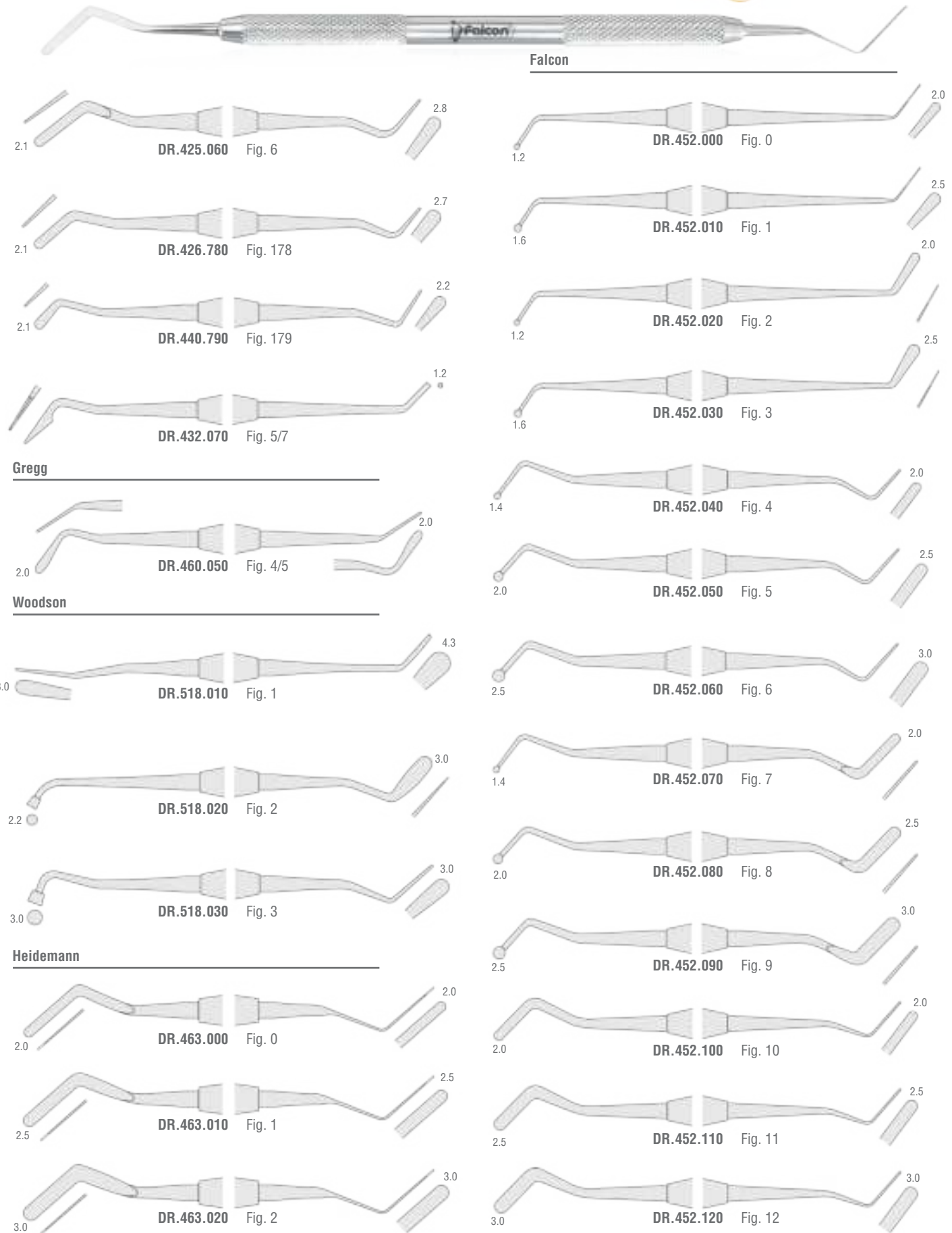

Restorative Conservativa

Composite/Plastic Filling Instruments / Strumenti per otturazioni plastiche

CLASSIC-LITE
8.0 mm hollow handle
Manico vuoto da 8,0 mm

Falcon

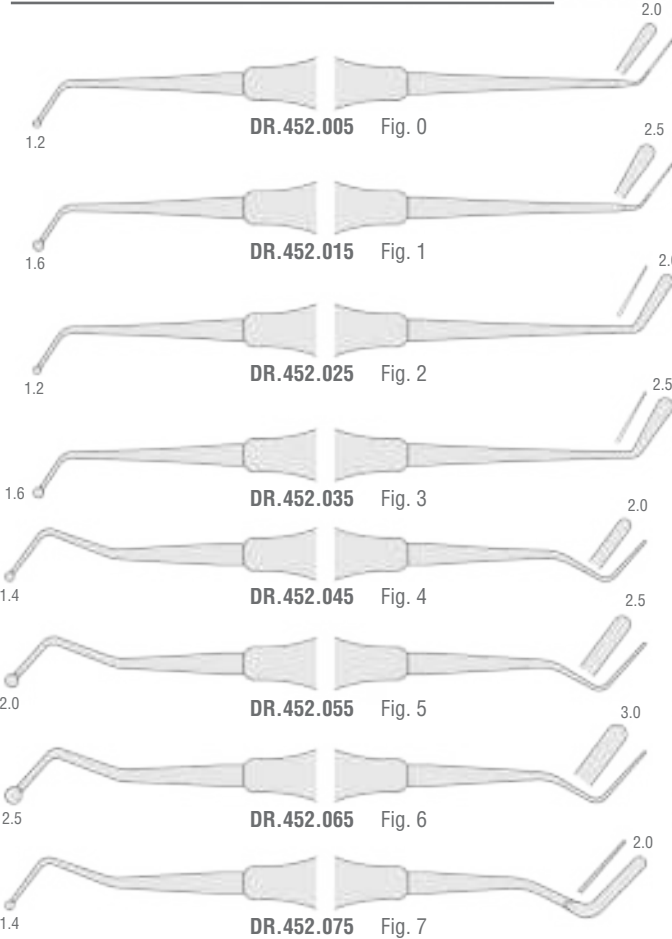

Falcon

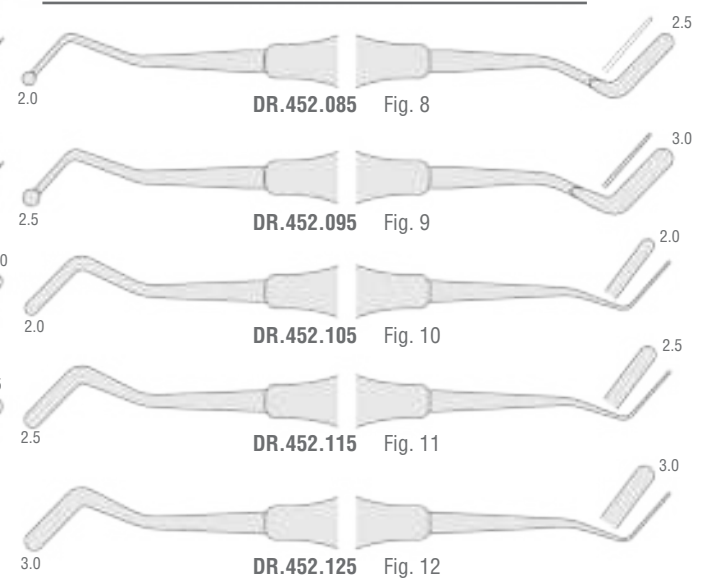

Heidemann

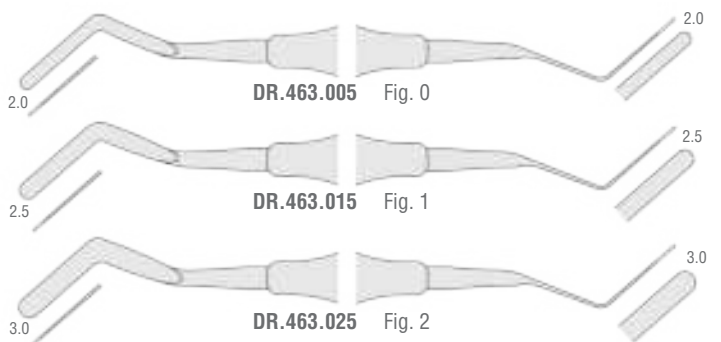

Classic-8
5.5 mm solid handle
Manico pieno da 5,5 mm

Heidemann

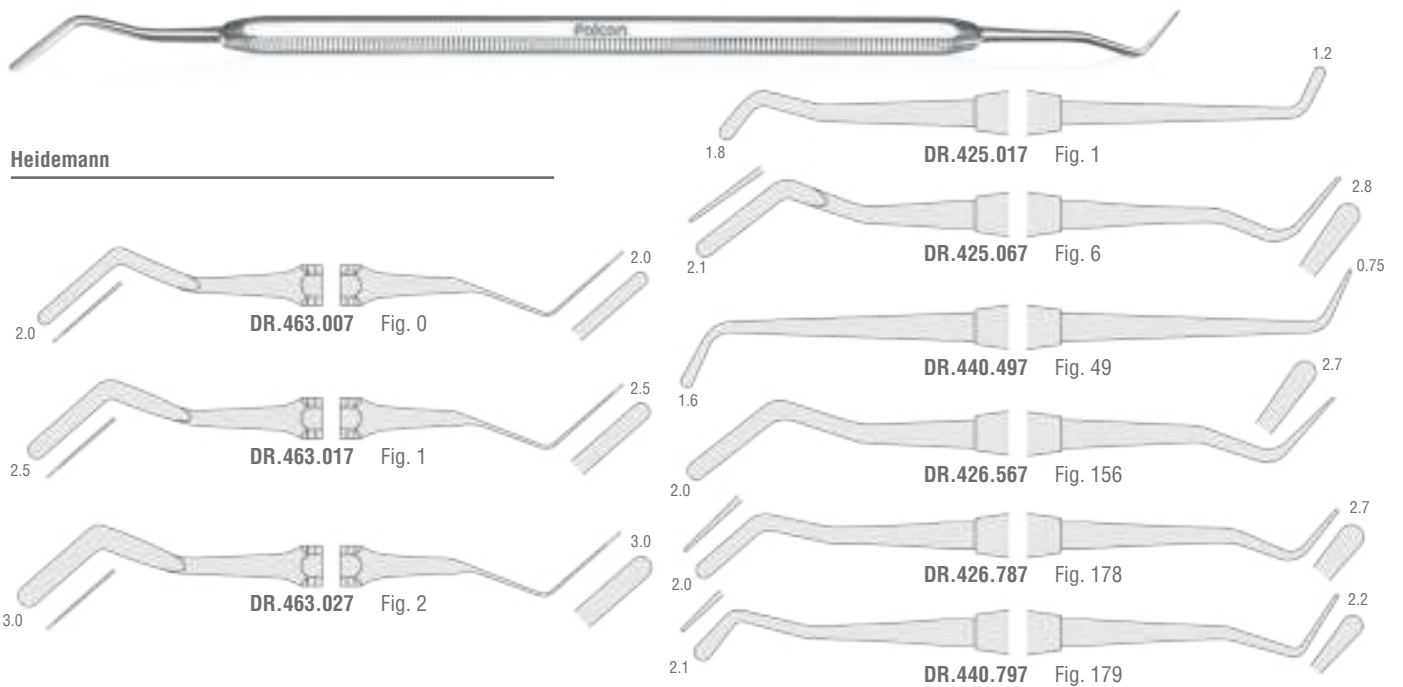

Cement Spatulae / Spatoline per cemento



DR.960.011 Fig. 1



DR.960.021 Fig. 2



DR.960.031 Fig. 3



DR.959.008 Fig. 00



DR.960.008 Fig. 0



DR.960.018 Fig. 1



DR.960.028 Fig. 2



DR.960.038 Fig. 3



DR.960.048 Fig. 4



DR.974.038 Weston



DR.980.027



DR.996.005

Glass mixing slabs / Piastre di miscelazione In vetro

- DR.998.010 95 x 70 x 5 mm
- DR.998.020 120 x 80 x 5 mm
- DR.998.030 150 x 80 x 12 mm



Restorative Conservativa

Gingival Margin Trimmers / Trimmer per il margine gengivale

Classic Round 6 mm solid handle
Manico pieno da 6mm



Blacks

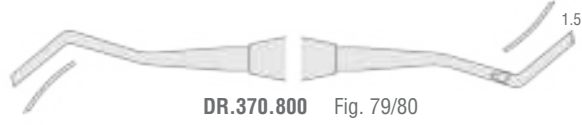
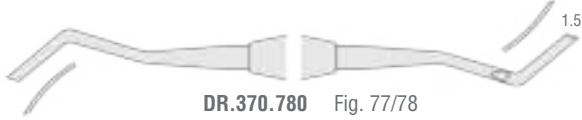

Ferrier

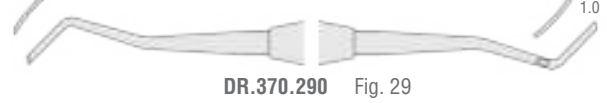
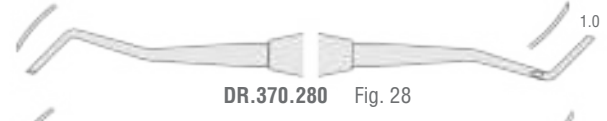
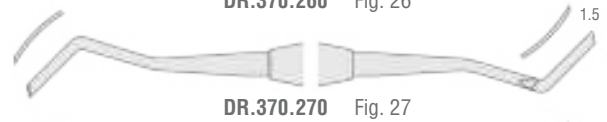
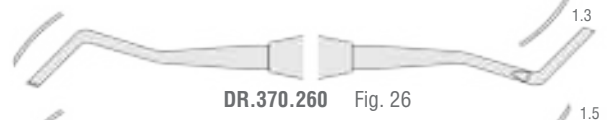

Excavators / Escavatori



Classic Round 6 mm solid handle
Manico pieno da 6mm

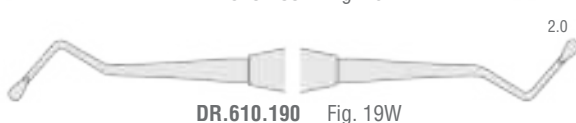
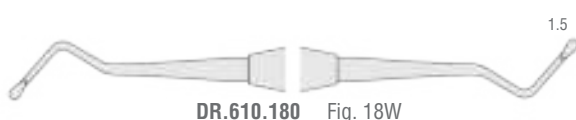
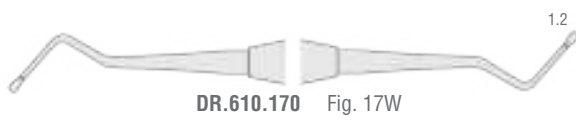
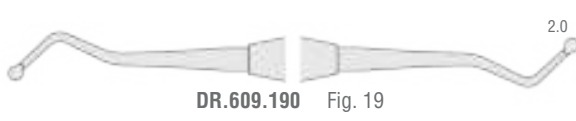
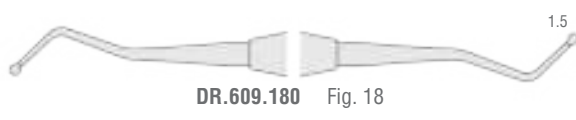
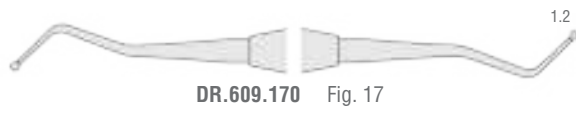
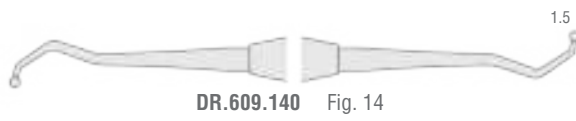

Falcon

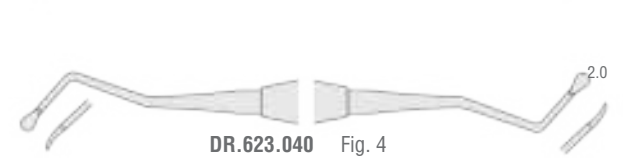
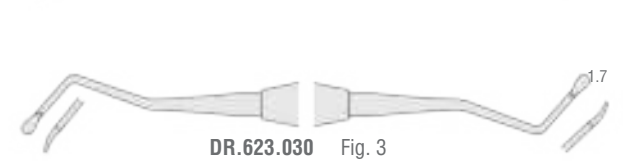
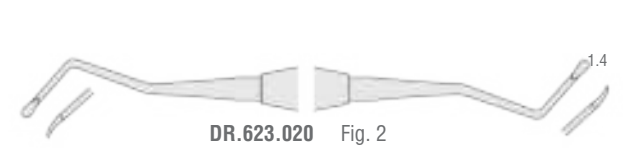
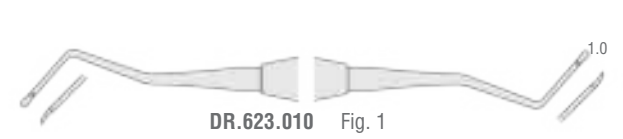
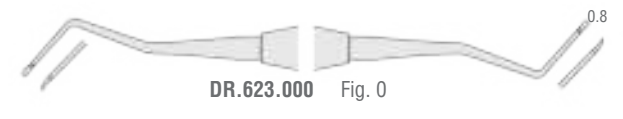

Carvers / Strumenti per modellare

Classic Round 6 mm solid handle
Manico pieno da 6mm

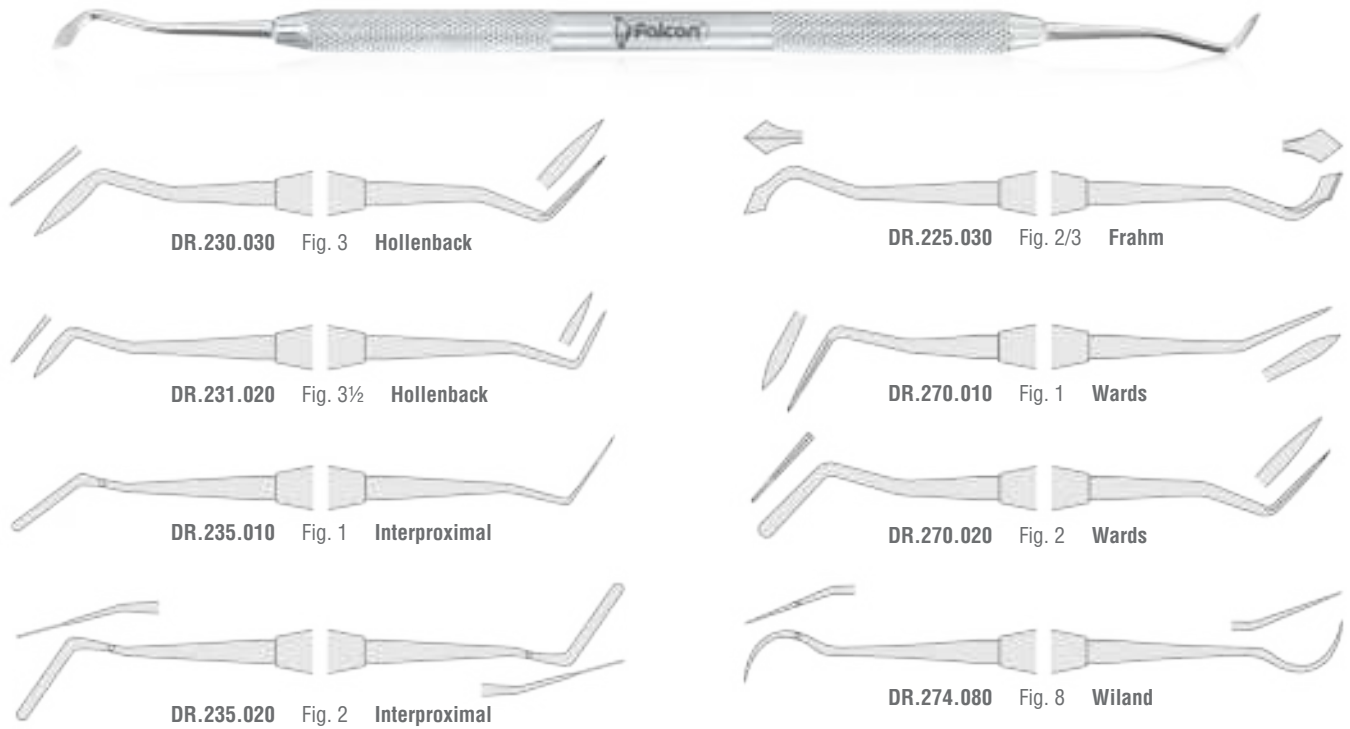

Finishing knives / Strumenti per rifinire otturazioni

Classic-Lite 10 mm hollow handle
Manico vuoto da 10 mm



Cleoid-Discoïd / Cleoidi-Discoïdi

Classic Round 6 mm solid handle
Manico pieno da 6mm

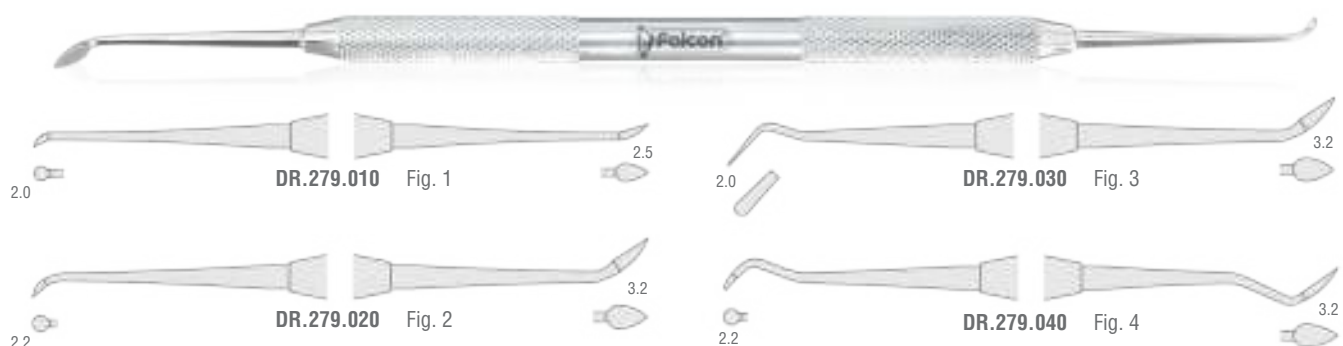

Restorative Conservativa

Falcon automatic crown and bridge remover Leva ponti e corone automatico Falcon

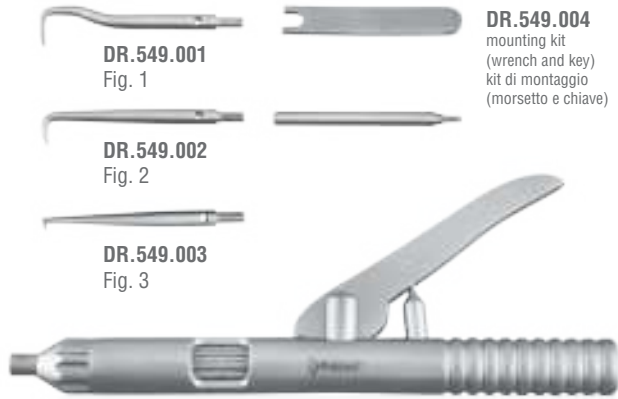

DR.549.001
Fig. 1

DR.549.002
Fig. 2

DR.549.003
Fig. 3

DR.549.004
mounting kit
(wrench and key)
kit di montaggio
(morsetto e chiave)

DR.549.000
Contents / Contiene:
1 Crown remover / Levacorone
3 Tips / Punta
1 Mounting kit (wrench and key)
kit di montaggio (morsetto e chiave)

DR.549.010
Set of 3 tips and mounting kit
Serie di 3 punte e kit di montaggio

Morrel manual crown remover with spring Levacorone manuale Morrel con molla

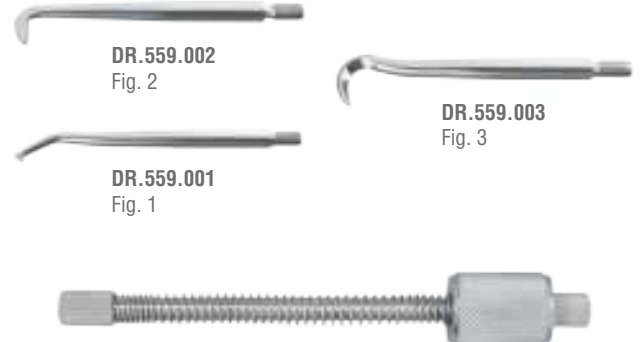

DR.559.002
Fig. 2

DR.559.001
Fig. 1

DR.559.003
Fig. 3

DR.560.000
Complete with 3 tips
Completo con 3 punte

DR.559.010
Set of 3 tips
Serie di 3 punte

Falcon manual crown remover double ended Levacorone doppio manuale Falcon

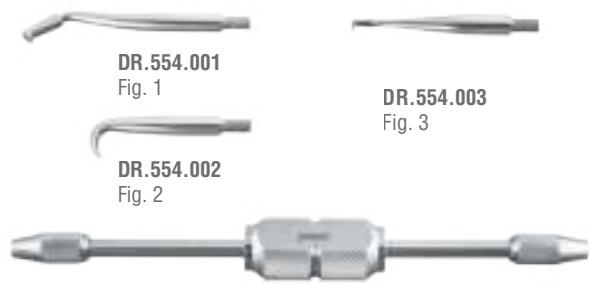

DR.554.001
Fig. 1

DR.554.002
Fig. 2

DR.554.003
Fig. 3

DR.554.000
Complete with 3 tips
Completo con 3 punte

DR.554.010
Set of 3 tips
Serie di 3 punte

Morrel manual crown remover Levacorone manuale Morrel



DR.559.002
Fig. 2

DR.559.001
Fig. 1

DR.559.003
Fig. 3

DR.559.000
Complete with 3 tips
Completo con 3 punte

DR.559.010
Set of 3 tips
Serie di 3 punte

Falcon manual crown remover double ended Levacorone doppio manuale Falcon



DR.555.001
Fig. 1

DR.555.002
Fig. 2

DR.555.000
Complete with 2 tips
Completo con 2 punte

DR.555.010
Set of 2 tips
Serie di 2 punte

Falcon manual crown remover single ended Levacorone singolo manuale Falcon



DR.555.001
Fig. 1

DR.555.002
Fig. 2

DR.556.000
Complete with 2 tips
Completo con 2 punte

Crown pliers / Pinze per corone



DR.532.160
Wynman-Falcon
160 mm
With Tungsten Carbide inserts
Con riporti al Carburo di Tungsteno



DR.531.160
Falcon
160 mm
With Tungsten Carbide inserts
Con riporti al Carburo di Tungsteno



DR.539.010
Furrer
160 mm



DR.535.000
With 10 tips
Con 10 punte

DR.535.010
Spare tips (5 pairs)
Punte di ricambio (5 paia)

Crown spreaders / Apricorone



DR.570.000
Falcon



DR.571.030
Fig. 3



Fig. 0
DR.571.000



Fig. 1
DR.571.010



Fig. 2
DR.571.020

Forceps for articulating paper / Pinzette per carta per articolazioni



DR.700.010
Miller
150 mm



DR.700.020
Miller
150 mm



DR.698.010
Falcon
150 mm



DR.699.010
Falcon
Full arch



Restorative Conservativa

Matrix bands / Matrici

Super flexible 0.04 mm
Super flessibile 0.04 mm



DR.799.050 5 mm x 10 m
DR.799.060 6 mm x 10 m
DR.799.070 7 mm x 10 m

Flexible 0.05 mm
Flessibile 0.05 mm



DR.800.050 5 mm x 10 m
DR.800.060 6 mm x 10 m
DR.800.070 7 mm x 10 m

Siqveland (pack of 12 / conf.12 pz.)



DR.809.010 Narrow / Stretta



DR.809.020 Wide / Larga

Matrix retainers / Porta matrici



DR.829.050
Falcon 5mm
with cheek protector/ con protezione guancia



DR.840.010
Tofflemire junior



DR.830.121
Fig. 12A
Ivory



DR.830.085 5 mm
DR.830.086 6 mm
DR.830.087 7 mm
Fig. 8
Ivory



DR.840.020
Tofflemire senior



DR.830.120
Fig. 12
Ivory



DR.830.089
Fig. 8N
Ivory



DR.840.030
Tofflemire universal



DR.832.010 Left/ Sinistro
DR.832.020 Right/ Destro
Nystrom



DR.835.010 Narrow / Stretta
DR.835.020 Wide / Larga
Siqveland



DR.855.010
Strip clamp straight
Morsetto per matrici dritto

Matrix pliers / Pinza per matrici



DR.820.170
Falcon
170 mm

Rubber dam clamps kits / Kit uncini per diga



DR.904.020

Contents / Contenuto:

- DR.906.100 Clamp / Uncino fig. 00
- DR.906.110 Clamp / Uncino fig. 0
- DR.906.120 Clamp / Uncino fig. 1
- DR.906.130 Clamp / Uncino fig. 2
- DR.906.140 Clamp / Uncino fig. 2A
- DR.906.530 Clamp / Uncino fig. 7
- DR.906.550 Clamp / Uncino fig. 8
- DR.906.560 Clamp / Uncino fig. 8A
- DR.906.090 Clamp / Uncino fig. 9
- DR.906.590 Clamp / Uncino fig. 14
- DR.906.600 Clamp / Uncino fig. 14A
- DR.906.212 Clamp / Uncino fig. 212
- DR.904.010 Clamps tray / Vassoio uncini



DR.904.030

Contents / Contenuto:

- DR.905.001 Clamp / Uncino fig. A
- DR.905.002 Clamp / Uncino fig. AW
- DR.905.003 Clamp / Uncino fig. BW
- DR.905.004 Clamp / Uncino fig. C
- DR.905.005 Clamp / Uncino fig. DW
- DR.905.006 Clamp / Uncino fig. E
- DR.905.007 Clamp / Uncino fig. EW
- DR.905.008 Clamp / Uncino fig. FW
- DR.905.009 Clamp / Uncino fig. G
- DR.905.013 Clamp / Uncino fig. K
- DR.905.014 Clamp / Uncino fig. L
- DR.905.015 Clamp / Uncino fig. M
- DR.904.010 Clamps tray / Vassoio uncini

Rubber dam clamps tray / Vassoio porta-uncini



DR.904.010

Falcon

185 x 90 x 20 mm



Restorative Conservativa

Rubber dam clamps / Uncini per diga

The range of 17 Rubber Dam clamps on this page is complete for any requirement. These clamps simplify the vast and confusing range of rubber dam clamps available in the market. These clamps substitute many existing patterns, comparison with old pattern clamps are given in brackets beside Figure.

La gamma dei 17 modelli di uncini rappresentati su questa pagina è in grado di coprire qualsiasi necessità e quindi di semplificare la vasta e talvolta confusa varietà di modelli presenti sul mercato. Ciascuno degli uncini in gamma può quindi sostituire molti dei vecchi modelli usati sin qui secondo le indicazioni fra parentesi a fianco di ciascun codice.



DR.905.001

Fig. A

(14,18A)

Molars, deciduous molars and part erupted teeth.

Molari, molari decidui e denti parzialmente spuntati.



DR.905.002

Fig. AW

(14,18A)

Molars, deciduous molars and part erupted teeth.

Molari, molari decidui e denti parzialmente spuntati.



DR.905.003

Fig. BW

(4,5,8,14)

Molars with good gingival retraction.

Molari con buona retrazione gengivale.



DR.905.004

Fig. C

(6,9,15,212)

Incisors, canines and bicuspid.

Incisivi, canini e bicuspidi.



DR.905.005

Fig. DW

(2, 7)

Small molars & large bicuspid.

Molari piccoli e bicuspidi grandi.



DR.905.006

Fig. E

(00,0,2,2A,9,15,18A)

All Incisors, canines and premoals with limited gingival retraction.

Tutti gli incisivi, canini e premolari con retrazione gengivale limitata.



DR.905.007

Fig. EW

(00,0,2,2A,9,15,18A)

All Incisors, canines and premoals with limited gingival retraction.

Tutti gli incisivi, canini e premolari con retrazione gengivale limitata.



DR.905.008

Fig. FW

(14A)

Very stable molar clamp.

Uncino molto stabile per molari.



DR.905.009

Fig. G

(1,2,2A)

Small 3rd molars, deciduous molars, bicuspid & canines.

Piccoli terzi molari, molari decidui, bicuspidi e canini.



DR.905.010

Fig. GW

(1,2,2A)

Small 3rd molars, deciduous molars, bicuspid & canines.

Piccoli terzi molari, molari decidui, bicuspidi e canini.



DR.905.011

Fig. HW

(14W)

Extended arch version of AW.

Versione estesa ad arco di AW.



DR.905.012

Fig. JW

(26A)

Large molars with deep gingival fit.

Grandi molari con inserimento gengivale profondo.



DR.905.013

Fig. K

(3,4,5,7A,8,10,11,26,7,8A)

General winged molar clamp.

Uncino alato per molari.



DR.905.014

Fig. L

(0)

Large jaw version of E.

Versione di E per mandibole di grandi dimensioni.



DR.905.015

Fig. M

(2)

Winged clamp for bicuspid.

Uncino alato per bicuspidi.



DR.905.016

Fig. NW

Medium size molar clamp.

Uncino medio per molari.



DR.905.017

Fig. PW

(9UW,W5)

Large, bland molar clamp.

Uncino grande per molari.

Rubber dam clamps / Uncini per diga

Anterior / Anteriori



DR.906.090
Fig. 9



DR.906.210
Fig. 210



DR.906.211
Fig. 211



DR.906.212
Fig. 212

Premolars / Premolari



DR.906.100
Fig. 00



DR.906.110
Fig. 0



DR.906.120
Fig. 1



DR.906.130
Fig. 2



DR.906.140
Fig. 2A



DR.906.020
Fig. 27



DR.906.150
Fig. 206



DR.906.180
Fig. 209

Molars / Molari



DR.906.500
Fig. 3



DR.906.510
Fig. 4



DR.906.530
Fig. 7



DR.906.550
Fig. 8



DR.906.560
Fig. 8A



DR.906.570
Fig. 12A



DR.906.580
Fig. 13A



DR.906.590
Fig. 14



DR.906.600
Fig. 14A



DR.906.370
Fig. 26



DR.906.620
Fig. 201



DR.906.660
Fig. 205



Restorative Conservativa

Plastic anatomical rubber dam frames Telai anatomico in plastica per diga



DR.937.060 85 x 105mm
Young



DR.937.020 115 mm
DR.937.030 80 mm



DR.937.040 98 x 74 mm
DR.937.050 148 x 102 mm

Stainless Steel Rubber dam frames Telai per diga in acciaio



DR.938.110 110 mm
DR.938.130 130 mm
DR.938.150 150 mm
Young



DR.937.000 150 mm
Falcon



DR.937.010 155 x 90 mm
Falcon

Rubber dam clamp forceps / Pinze per uncini



DR.928.170
IV
170 mm



DR.929.170
Falcon
170 mm



DR.926.170
Brewer
170 mm



DR.931.170
Stokes
170 mm



DR.932.170
Stokes/Palmer
170 mm

Rubber dam punches / Pinze per forare la diga



DR.940.160
Ainsworth
160 mm



DR.946.160
IV
160 mm

Rubber dam template / Dima per diga

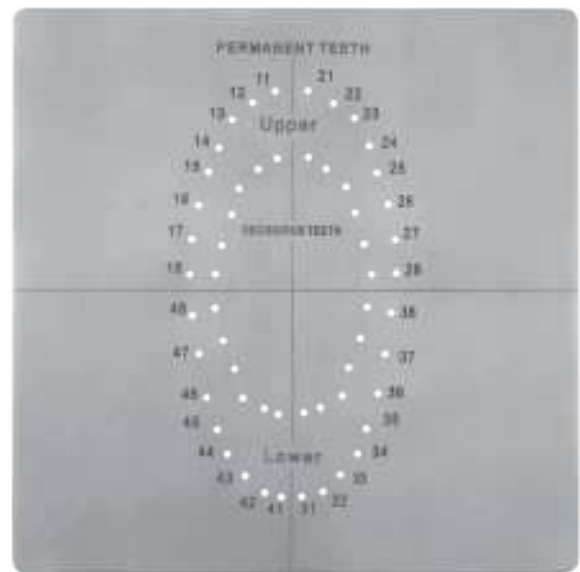

DR.948.000
150 x 150 mm
Autoclavable
Autoclavabile

Restorative Conservativa

Rubber dam Instruments set / Set di strumenti per diga

DR.900.000

Contents / Contenuto:

- a** DR.906.100 Clamp / Uncino fig. 00
- b** DR.906.110 Clamp / Uncino fig. 0
- c** DR.906.120 Clamp / Uncino fig. 1
- d** DR.906.130 Clamp / Uncino fig. 2
- e** DR.906.140 Clamp / Uncino fig. 2A
- f** DR.906.530 Clamp / Uncino fig. 7
- g** DR.906.550 Clamp / Uncino fig. 8
- h** DR.906.560 Clamp / Uncino fig. 8A
- i** DR.906.590 Clamp / Uncino fig. 14
- j** DR.906.600 Clamp / Uncino fig. 14A
- k** DR.906.090 Clamp / Uncino fig. 9
- l** DR.906.212 Clamp / Uncino fig. 212
- m** DR.904.010 Clamps tray / Vassoio uncini
- n** DR.928.170 Forceps / Pinza IV
- o** DR.938.130 Frame / Telaio Young 130 mm
- p** DR.946.160 Punch / Pinza per forara IV
- q** DR.948.000 Template / Dima per diga
- r** DZ.086.030 Tray / Vassoio
- s** DZ.430.090 Rack / Griglia



The set contains 1 each of the following instruments
Il set contiene 1 ciascuno dei seguenti strumenti



Rubber dam Instruments set / Set di strumenti per diga

DR.900.001

Contents / Contenuto:

- a DR.905.001** Clamp / Uncino fig. A
- b DR.905.002** Clamp / Uncino fig. AW
- c DR.905.003** Clamp / Uncino fig. BW
- d DR.905.004** Clamp / Uncino fig. C
- e DR.905.005** Clamp / Uncino fig. DW
- f DR.905.006** Clamp / Uncino fig. E
- g DR.905.007** Clamp / Uncino fig. EW
- h DR.905.008** Clamp / Uncino fig. FW
- i DR.905.009** Clamp / Uncino fig. G
- j DR.905.013** Clamp / Uncino fig. K
- k DR.905.014** Clamp / Uncino fig. L
- l DR.905.015** Clamp / Uncino fig. M
- m DR.904.010** Clamps tray / Vassoio uncini
- n DR.926.170** Forceps / Pinza Brewer
- o DR.938.130** Frame / Telaio Young 130 mm
- p DR.940.160** Punch / Pinza per forara Ainsworth
- q DR.948.000** Template / Dima per diga
- r DZ.086.030** Tray / Vassoio
- s DZ.430.100** Rack / Griglia



The set contains 1 each of the following instruments
Il set contiene 1 ciascuno dei seguenti strumenti



Restorative Conservativa

Rubber dam Instruments set / Set di strumenti per diga

DR.900.002

Contents / Contenuto:

- a** DR.906.100 Clamp / Uncino fig. 00
- b** DR.906.110 Clamp / Uncino fig. 0
- c** DR.906.120 Clamp / Uncino fig. 1
- d** DR.906.130 Clamp / Uncino fig. 2
- e** DR.906.140 Clamp / Uncino fig. 2A
- f** DR.906.530 Clamp / Uncino fig. 7
- g** DR.906.550 Clamp / Uncino fig. 8
- h** DR.906.560 Clamp / Uncino fig. 8A
- i** DR.906.090 Clamp / Uncino fig. 9
- j** DR.906.590 Clamp / Uncino fig. 14
- k** DR.906.600 Clamp / Uncino fig. 14A
- l** DR.906.212 Clamp / Uncino fig. 212
- m** DR.904.010 Clamps tray / Vassoio uncini
- n** DR.928.170 Forceps / Pinza IV
- o** DR.938.130 Frame / Telaio Young 130 mm
- p** DR.940.160 Punch/ Pinza per forara Ainsworth
- q** DR.948.000 Template / Dima per diga
- r** DZ.086.030 Tray / Vassoio
- s** DZ.430.100 Rack / Griglia



The set contains 1 each of the following instruments
Il set contiene 1 ciascuno dei seguenti strumenti





Anaesthesia
Anestesia

Intraligamental Syringes / Siringhe Intraligamentali

SS-2000
Stainless Steel Series

DA.010.180
Metric Thread
1.8 ml.
Falcon-Ject Ultima



- Made of 18-8 stainless steel
- Longer life than brass syringes
- No chipping of chrome
- Guaranteed quality
- Sterilizable by any method
- Prodotte in acciaio Inox 18-8
- Maggior durata rispetto al modello in ottone
- Assenza di cromatura che si può scagliare
- Qualità garantita
- Sterilizzabili con qualsiasi metodo

- Injects 0.05 ml with every click
- Exact dosage every time
- Supplied with angled and straight tubes
- Suitable for use with all 1.8ml dental cartridges
- Inietta 0,05ml, ad ogni scatto
- Dosaggio esatto ogni volta
- Fornita con terminale dritto o ad angolo
- Adatta con tutte le fiale da 1,8 ml, per uso dentale

DA.020.180
Metric Thread
1.8 ml.
Falcon-Ject



- Injects 0.06 ml with every click
- Exact dosage every time
- Suitable for use with all 1.8ml dental cartridges
- Inietta 0,06 ml ad ogni scatto.
- Dosaggio esatto ogni volta
- Adatta con tutte le fiale da 1,8 ml per uso dentale

DA.021.180
Metric Thread
1.8 ml.
Falcon-Ject



DA.094.180
Metric Thread
1.8 ml.
P-Ject



DA.035.000
Autoclavable plastic protection tube
Protezione in plastica autoclavabile



Self and Manual Aspirating Syringes / Siringhe ad aspirazione sia manuale che automatica

Self Aspiration: How it works

During use, the thumb pressure on the plunger or thumb disc stretches the diaphragm over a small metal projection inside of the syringe nozzle, increasing pressure inside of the cartridge. As the thumb pressure is released, pressure inside the cartridge lessens and aspiration occurs automatically. (Instruction for use are supplied with the product)

Auto aspirazione: Come funziona

Durante l'uso, la pressione esercitata sullo stantuffo o sul disco fa dilatare il diaframma posto sull'estremità della fiala. Questo contribuisce ad aumentare la pressione all'interno della fiala. Rilasciando lo stantuffo si determina una caduta della pressione che automaticamente si trasforma in aspirazione. (Istruzioni fornite con il prodotto)

SS-2000
Stainless Steel Series



DA.115.180
Metric Thread
1.8 ml.
Disc System



Disc System

Dual self aspiration system:

Disc system syringe has dual aspiration feature to achieve self aspiration.

Aspiration before injection:

Insert syringe in tissue and press Thumb disc to achieve aspiration.

Aspiration during injection:

Automatic aspiration occurs whenever pressure on the plunger is released.

A Disco

Duplici sistema auto aspirante:

La siringa a disco ha duplice effetto auto aspirante

Aspirazione prima dell'iniezione:

Inserire la siringa nel tessuto e premere il disco per ottenere l'aspirazione.

Aspirazione durante l'iniezione:

Al rilascio dello stantuffo si verifica una aspirazione automatica

DA.315.180
Metric Thread
1.8 ml.
Projection System



Projection System

Aspiration during injection:

Automatic aspiration occurs whenever pressure on the plunger is released.

A Proiezione

Aspirazione durante l'iniezione:

Al rilascio dello stantuffo si verifica una aspirazione automatica

DA.517.180
Metric Thread
1.8 ml.
Type-A



Dual aspiration system, self and manual aspirating syringes

During injection, aspiration can be achieved either manually by retracting the plunger backward or simply releasing pressure on plunger will produce self aspiration.

DA.557.180
Metric Thread
1.8 ml.
Type-C



Siringa a duplice effetto aspirante manuale o automatico

Durante l'iniezione si può ottenere l'aspirazione - o sollevando lo stantuffo (aspirazione manuale) - o rilasciando lo stantuffo (aspirazione automatica)

Manual Aspirating Syringes / Siringhe ad aspirazione manuale

SS-2000
Stainless Steel Series

DA.595.180
Metric Thread
1.8 ml.
Euro



DA.635.180
Metric Thread
1.8 ml.
T - Handle



DA.705.180
Metric Thread
1.8 ml.
3 - Ring



DA.801.180
Metric Thread
1.8 ml.
Euro
Breech loading, ring handle
Caricamento laterale, manico ad anello



DA.806.180
Metric Thread
1.8 ml.
Euro
Breech loading, T-handle
Caricamento laterale, manico a T





Brass Series Syringes / Siringhe serie ottone

- Made of brass
- Chrome plated
- All Brass series syringes have stainless steel plungers
- Guaranteed quality
- Sterilizable by any method
- Prodotte in ottone
- Cromate
- Tutte le siringhe della serie ottone hanno gli stantuffi in acciaio inox.
- Qualità garantita
- Sterilizzabili con qualsiasi metodo

Intraligamental syringes / Siringhe intraligamentali

DA.060.180
Metric Thread
1.8 ml.
Pistol - Ject



- Injects 0.20 ml with every click
- Exact dosage every time
- Lever action for high injection pressure
- Suitable for use with all 1.8ml dental cartridges

- Inietta 0,20 ml ad ogni scatto.
- Dosaggio esatto ogni volta
- Elevata pressione di iniezione grazie all' azione della leva
- Adatta con tutte le fiale da 1,8 ml per uso dentale

DA.095.180
Metric Thread
1.8 ml.
P-Ject



- Injects 0.06 ml with every click
- Exact dosage every time
- Suitable for use with all 1.8ml Dental cartridges

- Inietta 0,06 ml ad ogni scatto.
- Dosaggio esatto ogni volta
- Adatta con tutte le fiale da 1,8 ml per uso dentale

Self Aspirating Syringes / Siringhe autoaspiranti

DA.145.180
Metric Thread
1.8 ml.
Disc System



Anaesthesia Anestesia

Manual Aspirating Syringes / Siringhe ad aspirazione manuale



DA.520.180
Metric Thread
1.8 ml.
Type-A



DA.560.180
Metric Thread
1.8 ml.
Type-C



DA.561.180
Metric Thread
1.8 ml.
P-Ject



Special aspiration tip for use with 1.8ml cartridges with hole. (May also be used with traditional cartridges. (without aspiration).

Per aspirazione con cartucce 1,8 ml munite di stantuffo con speciale incavo. Possono essere usate anche con cartucce tradizionali. (Senza aspirazione)

DA.721.180
Metric Thread
1.8 ml.
3 - Ring



DA.735.180
Metric Thread
1.8 ml.
2 - Ring





Manual Aspirating Syringes / Siringhe ad aspirazione manuale

DA.620.180
Metric Thread
1.8 ml.
Euro



DA.819.180
Metric Thread
1.8 ml.
Euro
Breech loading, ring handle
Caricamento laterale, manico ad anello



DA.820.180
Metric Thread
1.8 ml.
Euro
Breech loading, ring handle
Caricamento laterale, manico ad anello



DA.821.180
Metric Thread
1.8 ml.
Euro
Breech loading, T - handle
Caricamento laterale, manico a T



Non-aspirating syringe / Siringa non aspirante

DA.835.180
Metric Thread
1.8 ml.
Euro
Breech loading, T - handle
Caricamento laterale, manico a T



Anaesthesia Anestesia

Needle Re-cappers / Base riponi ago

SS-2000
Stainless Steel Series

Falcon Needle Re-Cappers are the ideal way to prevent needle stick injuries when recapping needles. Place the upturned needle cap into Falcon Re-Capper and re-sheathing becomes a simple one hand procedure.

Il Falcon Needle Re-capper (base riponi ago) consente di riporre l' ago nel suo cappuccio dopo l'uso evitando spiacevoli ferite. Porre il cappuccio con l'apertura rivolta verso l'alto nel Falcon Needle Re-capper, Il re-instrimento dell' ago nel suo cappuccio diviene un' operazione sicura da eseguire con una sola mano.



DA.980.000
Needle Re-Capper



DA.990.000
Needle Re-Capper
Ultima



Atraumatic Extraction
Estrazione atraumatica

Atraumatic Extraction

Estrazione atraumatica

Luxating Hybrids / Leve ibride

HYBRIDS

A combination of a perioste and a luxating root elevator, to cut the periodontal ligaments in preparation for tooth extraction and minimize trauma.

IBRIDE

Le leve ibride nascono dal connubio tra un periostoma ed una leva lussatrice per tagliare i legamenti parodontali prima dell'estrazione del dente, minimizzando i traumi all'osso e ai tessuti circostanti dovuti all'estrazione.



DE.917.010
2,5 mm
Straight, micro serrated
Dritta, micro zigrinata



DE.917.020
2,5 mm
Curva, micro zigrinata
Curved, micro serrated



DE.917.030
2,5 mm
Distale a baionetta, micro zigrinata
Bayonet distal, micro serrated



DE.917.040
2,5 mm
Distale mesiale, micro zigrinata
Mesial, micro serrated



DE.917.050
4,0 mm
Distale a baionetta, micro zigrinata
Bayonet distal, micro serrated



DE.917.060
4,0 mm
Mesiale a baionetta, micro zigrinata
Bayonet mesial, micro serrated



DE.917.070
3,5 mm - Bernhard
Dritta, micro zigrinata
Straight, micro serrated

Luxating Hybrids / Leve ibride

HYBRIDS

A combination of a periosteal elevator and a luxating root elevator, to cut the periodontal ligaments in preparation for tooth extraction and minimize trauma.

IBRIDE

Le leve ibride nascono dal connubio tra un periotomo ed una leva lussatrice per tagliare i legamenti parodontali prima dell'estrazione del dente, minimizzando i traumi all'osso e ai tessuti circostanti dovuti all'estrazione.



DE.917.110
3,5 mm - Bernhard
Dritta
Straight



DE.917.120
3,5 mm - Bernhard
Sinistra
Left



DE.917.130
3,5 mm - Bernhard
Destra
Right



DE.917.140
3,5 mm - Bernhard
Distale a baionetta
Bayonet distal



DE.917.150
3,5 mm - Bernhard
Mesiale a baionetta
Bayonet mesial



DE.917.160
4,5 mm
Mesiale
Mesial



DE.917.170
4,5 mm
Distale
Distal



Atraumatic Extraction

Estrazione atraumatica

Periotomes / Periotomi

PERIOTOMES

Periotomes are dental instruments used to cut periodontal ligaments for atraumatic tooth extractions and dental implant placement. They have thin sharp blades to facilitate the removal of teeth with minimal damage to surrounding alveolar bone.

PERIOTOMI

I periotomi sono strumenti dentali utilizzati per scollare i legamenti del dente, per permettere un'estrazione atraumatica ed un miglior posizionamento dell'impianto dentale.

La lama fine e affilata facilita la rimozione dei denti in maniera minimamente invasiva permettendo di danneggiare al minimo l'osso alveolare circostante.



DP.690.015 Fig. 1



DP.690.025 Fig. 2



DP.690.035 Fig. 3

Ergo - form periotome kit / Ergo - form kit periotomo



DP.698.000
Kit with 4 tips / Kit con 4 punte



DP.698.010 Fig. 1



DP.698.020 Fig. 2



DP.698.030 Fig. 3



DP.698.040 Fig. 4



DP.698.001
Handle / Manico

Luxating Elevators / Leve "Luxation"

Ergo-form Elevators



Falcon



DE.920.015 Fig. 1



DE.920.025 Fig. 2



DE.920.035 Fig. 3



DE.920.045 Fig. 4



DE.920.055 Fig. 5



DE.920.065 Fig. 6



DE.920.075 Fig. 7



Falcon



DE.920.010 Fig. 1



DE.920.020 Fig. 2



DE.920.030 Fig. 3



DE.920.040 Fig. 4



DE.920.050 Fig. 5



DE.920.060 Fig. 6



DE.920.070 Fig. 7



DE.920.000
Set of 7 / Serie di 7



Atraumatic Extraction Estrazione atraumatica

Syndesmotomes / Sindesmotomi



DE.929.010
110 mm



DE.930.000
Fig. 0



DE.930.010
Fig. 1



DE.930.020
Fig. 2



DE.930.030
Fig. 3



DE.930.040
Fig. 4



DE.930.050
Fig. 5



DE.930.060
Fig. 6



DE.930.070
Fig. 7



DE.930.080
Fig. 8



DE.930.090
Fig. 9



DE.930.110
Fig. 11

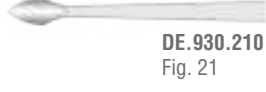

DE.930.210
Fig. 21

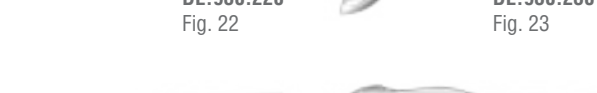

DE.930.220
Fig. 22



DE.930.230
Fig. 23



DE.930.240
Fig. 24



DE.930.250
Fig. 25



DE.930.260
Fig. 26



DE.930.270
Fig. 27



DE.930.280
Fig. 28



DE.930.290
Fig. 29

Syndesmotomes Sets / Serie di Sindesmotomi



DE.931.010
Set of 11 tips (fig. 0-11) + 1 handle in box
Serie di 11 punte (fig. 0-11) + manico con vassoio

DE.931.020
Set of 20 tips (fig. 0-29) + 1 handle in box
Serie di 20 punte (fig. 0-29) + manico con vassoio



Chompret



DE.925.010
Fig. 1



DE.925.020
Fig. 2



DE.925.030
Fig. 3



DE.925.040
Fig. 4

Atraumatic Extraction Forceps / Pinze per estrazione atraumatica

Deep and Secure Grip

Fine and sharp beaks cut trough periodontium to achieve contact with root structure.

Reduce Fracture of Crown and Roots

Anatomically shaped to perfectly match the teeth and allow to reach deep and large contact areas to provide secure grip, thus avoiding fracture of the brittle crown.

Reduce Trauma of Soft Tissues

The fine beaks fit in areas where standard design cannot be applied and reduce trauma to the soft tissues as they are reflected rather than crushed.

Presenza Profonda e Sicura

Le punte fini e taglienti tagliano il parodonto permettendo di raggiungere la struttura delle radici.

Riduzione delle fratture di corone e radici

La sagoma anatomica permette di adattarsi perfettamente ai denti e di raggiungere zone di contatto ampie e profonde evitando la frattura delle (fragili) corone.

Riduzione di Traumi ai Tessuti Molli

Le punte rastremate consentono di raggiungere zone inaccessibili ai modelli in uso comune e permettono quindi di ridurre i traumi ai tessuti molli che vengono divaricati anzichè schiacciati.



DE.910.340

Fig. 34

Upper Incisors
Incisivi e canini superiori



DE.910.341

Fig. 34A

Upper Incisors
Incisivi e canini superiori



DE.910.350

Fig. 35

Upper Bicuspid
Premolari superiori

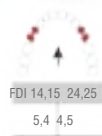

DE.910.351

Fig. 35A

Upper Bicuspid
Premolari superiori



DE.910.360

Fig. 36

Lower Incisors and Canines
Incisivi e canini inferiori

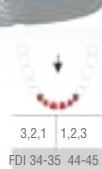

DE.910.361

Fig. 36A

Lower Incisors and Canines
Incisivi e canini inferiori

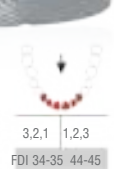

Atraumatic Extraction Estrazione atraumatica

Atraumatic Extraction Forceps / Pinze per estrazione atraumatica



DE.910.343
Fig. 34M
Upper Incisors
Incisivi e canini superiori



DE.910.344
Fig. 34N
Upper Incisors and Canines
Incisivi e canini superiori



DE.910.353
Fig. 35M
Upper Bicusps
Premolari superiori

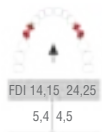

DE.910.354
Fig. 35N
Upper Bicusps
Premolari superiori



DE.910.361
Fig. 36M
Lower Incisors, Canines and Bicusps
Incisivi, canini e premolari inferiori



DE.910.364
Fig. 36N
Lower Incisors, Canines and Bicusps
Incisivi, canini e premolari inferiori



DE.910.674
Fig. 67N
Upper Molars
Molari superiori

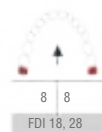

DE.910.794
Fig. 79N
Lower Molars
Molari inferiori

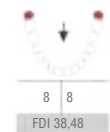



Extraction
Estrazione

Extraction Estrazione

Instrument Sets for Extraction and Oral Surgery / Set strumenti per estrazione e per la chirurgia orale

DE.999.001

Set of 9 pieces / Serie di 9 pezzi
Contents / Contenuto:

- DE.750.331 Extracting forceps fig. 33A / Pinza per estrazione fig. 33A
- DE.750.511 Extracting forceps fig. 51A / Pinza per estrazione fig. 51A
- DE.750.671 Extracting forceps fig. 67A / Pinza per estrazione fig. 67A
- DE.750.790 Extracting forceps fig. 79 / Pinza per estrazione fig. 79
- DE.086.020 Elevator Flohr left fig. 2 / Leva Flohr sinistra fig. 2
- DE.086.030 Elevator Flohr right fig. 3 / Leva Flohr destra fig. 3
- DE.025.060 Elevator Bein 3mm fig. 6 / Leva Bein 3mm fig. 6
- DE.270.125 Elevator Winter left fig. 12L / Leva Winter sinistra fig. 12L
- DE.270.127 Elevator Winter right fig. 12R / Leva Winter destra fig. 12R



DE.999.002

Set of 9 pieces / Serie di 9 pezzi
Contents / Contenuto:

- DE.750.331 Extracting forceps fig. 33A / Pinza per estrazione fig. 33A
- DE.750.511 Extracting forceps fig. 51A / Pinza per estrazione fig. 51A
- DE.750.671 Extracting forceps fig. 67A / Pinza per estrazione fig. 67A
- DE.750.790 Extracting forceps fig. 79 / Pinza per estrazione fig. 79
- DE.086.020 Elevator Flohr left fig. 2 / Leva Flohr sinistra fig. 2
- DE.086.030 Elevator Flohr right fig. 3 / Leva Flohr destra fig. 3
- DE.025.060 Elevator Bein 3mm fig. 6 / Leva Bein 3mm fig. 6
- BN.414.140 Falcon-Grip Needle holder Mathieu 140mm TC / Falcon-Grip porta aghi Mathieu 140mm TC
- BN.298.160 Falcon-Grip Needle holder Mayo-Hegar 160mm TC / Falcon-Grip porta aghi Mayo-Hegar 160mm TC



Root Elevators / Leve per radici

Ergo-form Elevators



Tips are made of special grade stainless steel and are TIN coated:

Benefits:

- Edge stays sharp longer
- Longer life than ordinary stainless steel elevators
- Improved smoothness for easy sliding in and out
- Non toxic TIN coating

Available in new and existing best selling models

Punte realizzate con acciai speciali e rivestite con Nitruro di Titanio

Vantaggi:

- Maggiore durata dell'affilatura
- Maggiore durata rispetto alle leve in acciaio tradizionale
- Le superfici lisce rendono l'intervento più agevole
- Rivestimento TIN atossico

Disponibili in modelli nuovi e tradizionali



Falcon
Serrated / Zigrinate

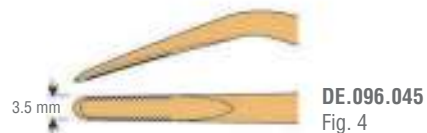
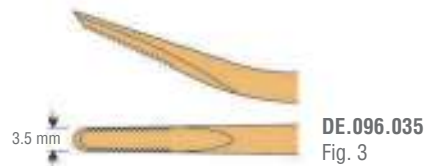
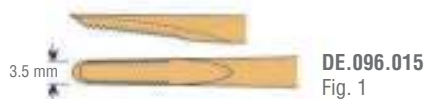
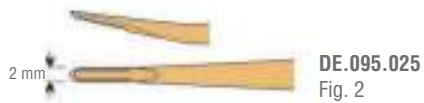

Bein

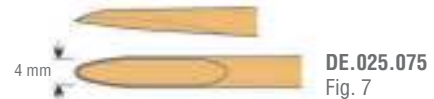

Extraction Estrazione

Root Elevators / Leve per radici

Ergo-form Elevators



3.5 mm
DE.086.025
Fig. 2
Flohr



3.5 mm
DE.086.035
Fig. 3
Flohr



2.5 mm
DE.290.015
Fig. 1
Heidebrink



2.5 mm
DE.290.025
Fig. 2
Heidebrink



2.5 mm
DE.290.035
Fig. 3
Heidebrink



4.0 mm
DE.285.115
Fig. 11
Bernhard



4.0 mm
DE.285.065
Fig. 6
Bernhard



4.0 mm
DE.285.075
Fig. 7
Bernhard



10 mm
DE.060.305
Fig. 30
Cryer



10 mm
DE.060.315
Fig. 31
Cryer



3.0 mm
DE.050.015
Fig. 1
Coupland



3.5 mm
DE.050.025
Fig. 2
Coupland



4.0 mm
DE.050.035
Fig. 3
Coupland



3.0 mm
DE.190.085
Warwick-James



6.5 mm
DE.190.055
Warwick-James



6.5 mm
DE.190.075
Warwick-James

Root Elevators / Leve per radici



Apical



Coupland

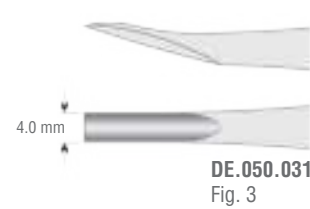
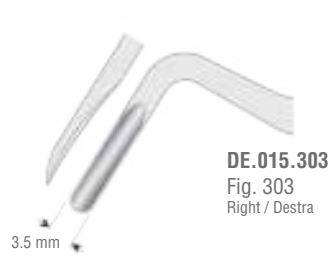
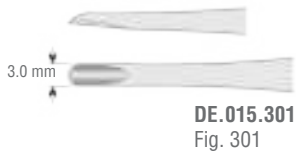

Bein



Cryer

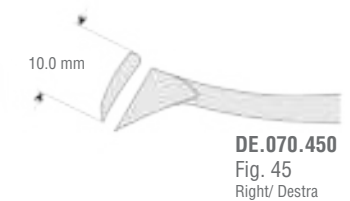
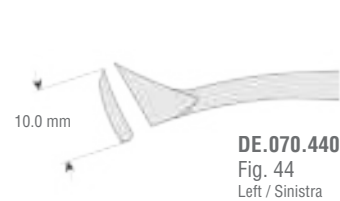
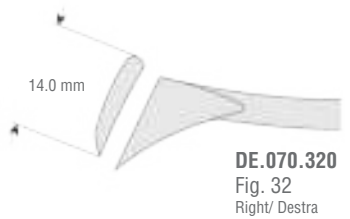
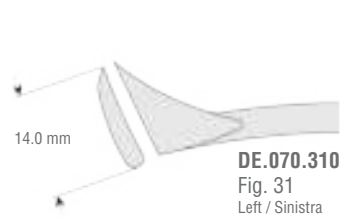
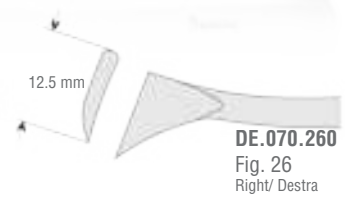
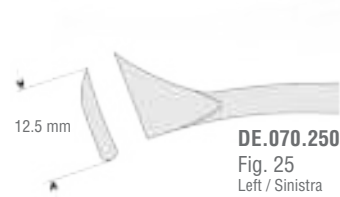

Extraction Estrazione

Root Elevators / Leve per radici



Seldin



Hyllin

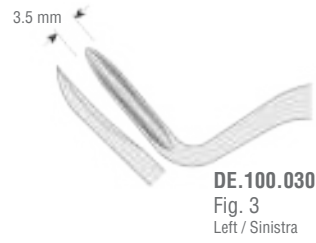
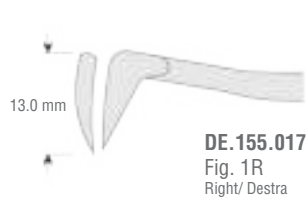
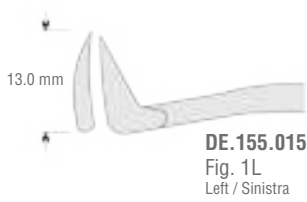

Flohr

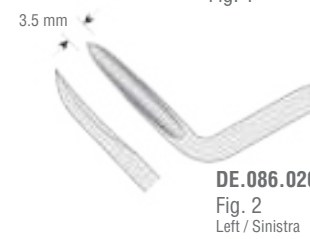

Schmeckebeier

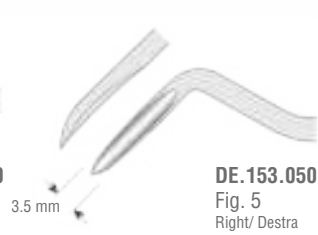
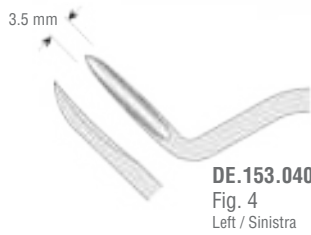

Friedman

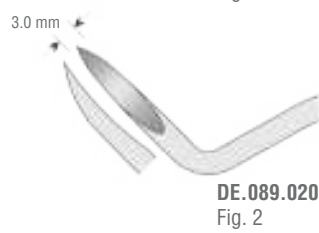

Root Elevators / Leve per radici

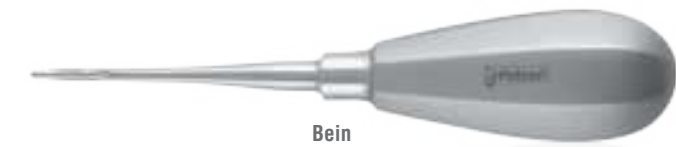

Bein

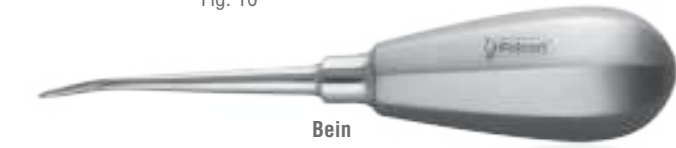
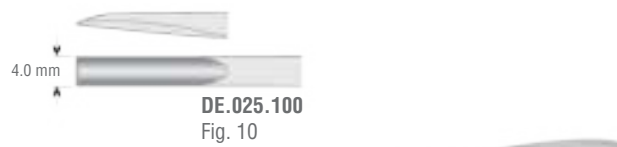
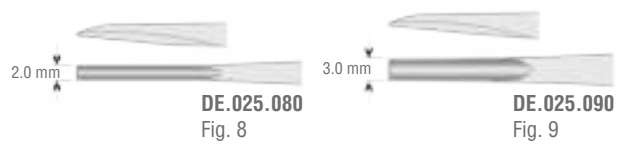
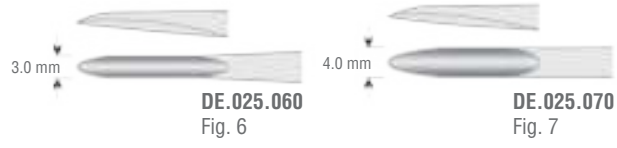
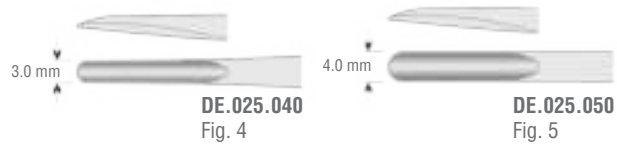
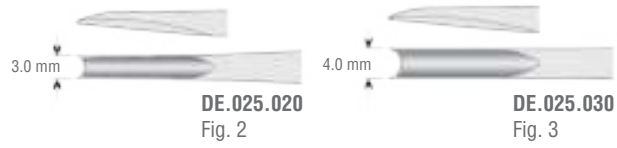
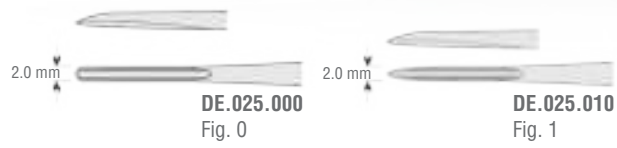

Bein

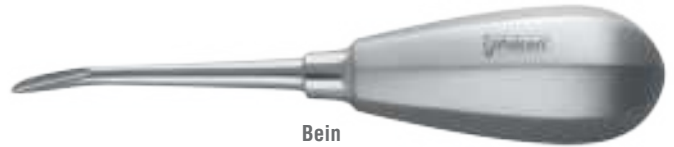

Bein

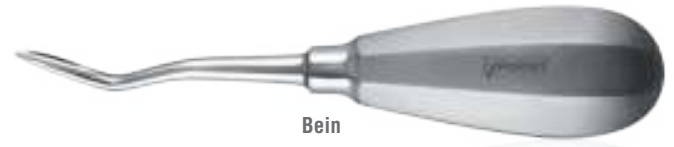
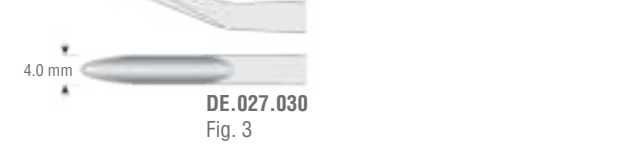

Bein



Extraction Estrazione

Root Elevators / Leve per radici



Cryer



Lindo-Levian

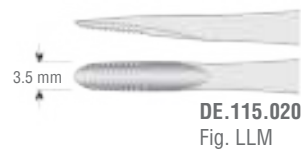

Warwick-James

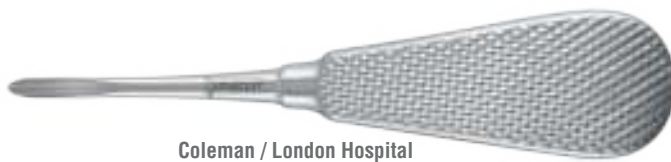

Coleman / London Hospital

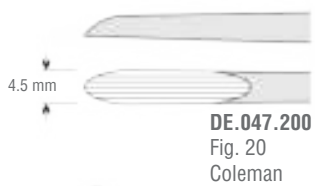

Root Elevators / Leve per radici



Bein



2.0 mm

DE.025.011
Fig. 1



3.0 mm

DE.025.061
Fig. 6



4.0 mm

DE.025.071
Fig. 7



14.0 mm

DE.110.010
Fig. 1
Left / Sinistra



14.0 mm

DE.110.020
Fig. 2
Right / Destra



Flohr



3.5 mm

DE.086.011
Fig. 1

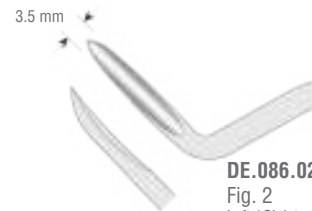

3.5 mm

DE.086.021
Fig. 2
Left / Sinistra



3.5 mm

DE.086.031
Fig. 3
Right / Destra

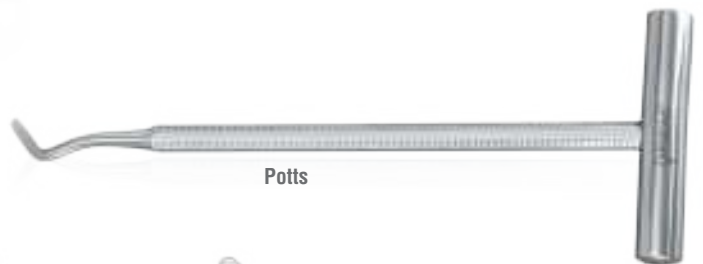

Potts



11.0 mm

DE.255.060
Fig. 6
Left / Sinistra



11.0 mm

DE.255.070
Fig. 7
Right / Destra



Schlemmer



11.0 mm

DE.154.010
Fig. 1



11.0 mm

DE.154.020
Fig. 2



Extraction Estrazione

Root Elevators / Leve per radici

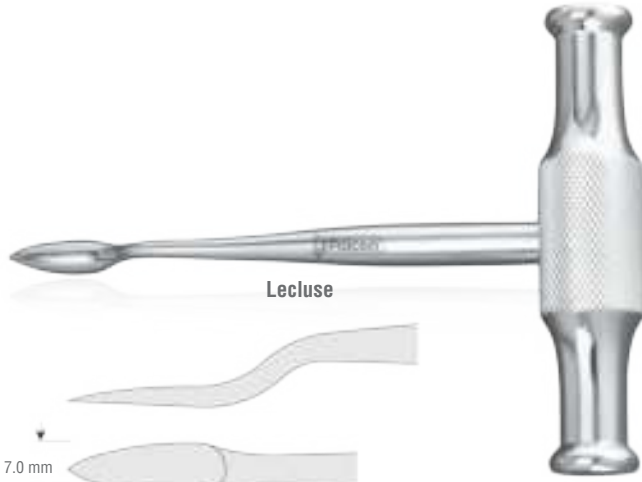

7.0 mm
DE.247.010
Fig. 1

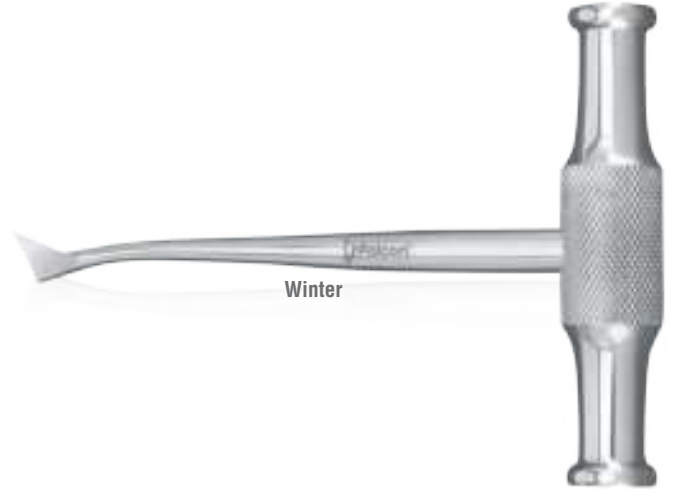

4.0 mm
DE.270.015
Fig. 1L
Left / Sinistra

4.0 mm
DE.270.017
Fig. 1R
Right / Destra

8.0 mm
DE.270.115
Fig. 11L
Left / Sinistra

8.0 mm
DE.270.117
Fig. 11R
Right / Destra

10.0 mm
DE.270.125
Fig. 12L
Left / Sinistra

10.0 mm
DE.270.127
Fig. 12R
Right / Destra

12.0 mm
DE.270.135
Fig. 13L
Left / Sinistra

12.0 mm
DE.270.137
Fig. 13R
Right / Destra

13.0 mm
DE.270.145
Fig. 14L
Left / Sinistra

13.0 mm
DE.270.147
Fig. 14R
Right / Destra



7.5 mm
DE.265.320
Fig. 320
Left / Sinistra

7.5 mm
DE.265.321
Fig. 321
Right / Destra

10.0 mm
DE.265.322
Fig. 322
Left / Sinistra

10.0 mm
DE.265.323
Fig. 323
Right / Destra

13.0 mm
DE.265.350
Fig. 350
Left / Sinistra

13.0 mm
DE.265.351
Fig. 351
Right / Destra

Root tip picks / Leve per frammenti di radici

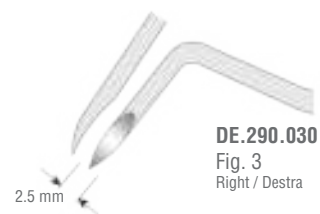
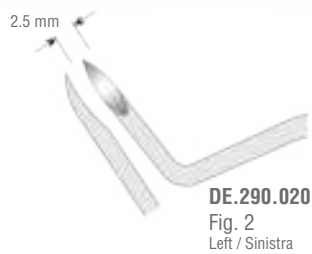
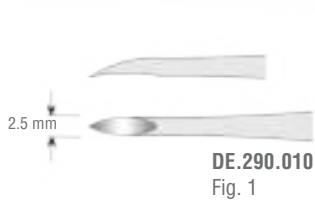

Extraction Estrazione

Extraction Forceps / Pinze Per Estrazione

500 SERIES

Children Pattern / Per Bambini



4.0 mm

DE.500.137

Fig. 13S

Lower Premolars / Premolari Inferiori



5.5 mm

DE.500.227

Fig. 22S

Lower Molars / Molari Inferiori



4.0 mm

DE.500.307

Fig. 30S

Upper Roots / Radici Superiori



3.5 mm

DE.500.337

Fig. 33S

Lower Roots / Radici Inferiori



4.0 mm

DE.500.370

Fig. 37

Upper Incisors / Incisivi Superiori



4.0 mm

DE.500.380

Fig. 38

Lower Incisors and Canines / Incisivi e Canini Inferiori



5.0 mm

DE.500.390

Fig. 39

Upper Molars / Molari Superiori



5.5 mm

DE.500.395

Fig. 39L

Upper Molars, Left / Molari Superiori, Sinistri

Extraction Forceps / Pinze Per Estrazione

500 SERIES

Children Pattern / Per Bambini



DE.500.397

Fig. 39R

Upper Molars, Right / Molari Superiori, Destri



DE.500.517

Fig. 51S

Upper Roots / Radici Superiori



DE.500.001

Set of 10 / Serie di 10

Contents / Contenuto:

- DE.500.137** Fig. 13S
- DE.500.227** Fig. 22S
- DE.500.307** Fig. 30S
- DE.500.337** Fig. 33S
- DE.500.370** Fig. 37
- DE.500.380** Fig. 38
- DE.500.390** Fig. 39
- DE.500.395** Fig. 39L
- DE.500.397** Fig. 39R
- DE.500.517** Fig. 51S



Extraction Estrazione

Extraction Forceps / Pinze Per Estrazione

500 SERIES

Children Pattern / Per Bambini



DE.650.030

Fig. 3

Upper Molars / Molari Superiori



DE.650.050

Fig. 5

Lower Incisors / Incisivi Inferiori



DE.650.060

Fig. 6

Lower Molars / Molari Inferiori



DE.650.070

Fig. 7

Lower Roots / Radici Inferiori



DE.650.517

Fig. 51S

Upper Roots / Radici Superiori

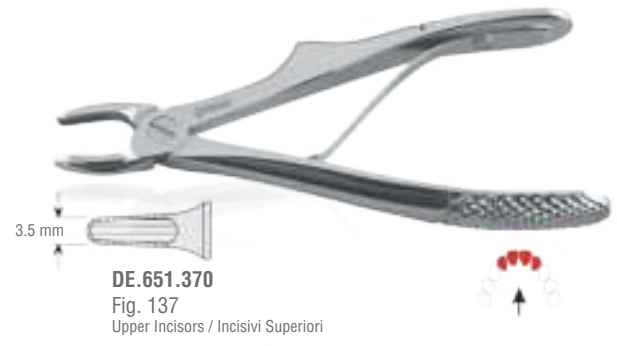

DE.651.370

Fig. 137

Upper Incisors / Incisivi Superiori



DE.651.390

Fig. 139

Upper Premolars / Premolari Superiori



DE.650.000

Set of 7 / Serie di 7

Contents / Contenuto:

DE.650.030 Fig. 3

DE.650.050 Fig. 5

DE.650.060 Fig. 6

DE.650.070 Fig. 7

DE.650.517 Fig. 51S

DE.651.370 Fig. 137

DE.651.390 Fig. 139

Extraction Forceps European Pattern / Pinze Per Estrazione Mod. Europeo

750 SERIES Standard Grip / Manico Standard



DE.750.010
Fig. 1
Upper Centrals & Canines/Cuspids
Incisivi e Canini Superiori



DE.750.020
Fig. 2
Upper Laterals & Canines/Cuspids
Incisivi e Canini Superiori



DE.750.040
Fig. 4
Lower Incisors & Canines/Cuspids
Incisivi e Canini Inferiori

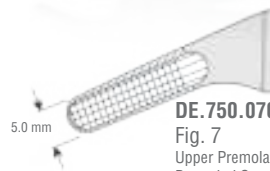

DE.750.070
Fig. 7
Upper Premolars & Bicuspids
Premolari Superiori



DE.750.080
Fig. 8
Lower Premolars/Bicuspids / Premolari Inferiori

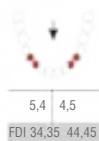

DE.750.130
Fig. 13
Lower Premolars/Bicuspids
Premolari Inferiori

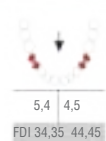

DE.750.170
Fig. 17
Upper Molars, Right
Molari Superiori, Destri

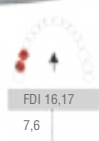

DE.750.180
Fig. 18
Upper Molars, Left
Molari Superiori, Sinistri

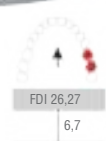

Extraction Estrazione

Extraction Forceps European Pattern / Pinze Per Estrazione Mod. Europeo

750 SERIES

Standard Grip / Manico Standard



7.0 mm
DE.750.181
Fig. 18A
Upper Molars
Molari Superiori



7.0 mm
DE.750.190
Fig. 19
Upper Third Molars
Denti Del Giudizio Superiori

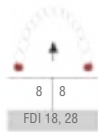

7.0 mm
DE.750.210
Fig. 21
Lower Molars
Molari Inferiori

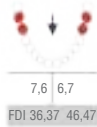

7.0 mm
DE.750.220
Fig. 22
Lower Molars
Molari Inferiori

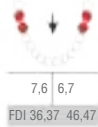

7.0 mm
DE.750.230
Fig. 23
Lower Molars, Right
Molari Inferiori, Destri

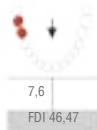

7.0 mm
DE.750.240
Fig. 24
Lower Molars, Left
Molari Inferiori, Sinistri

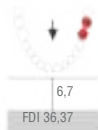

4.0 mm
DE.750.290
Fig. 29
Upper Roots
Radici Superiori



3.0 mm
DE.750.295
Fig. 29N
Upper Roots
Radici Superiori



Extraction Forceps European Pattern / Pinze Per Estrazione Mod. Europeo

750 SERIES Standard Grip / Manico Standard



DE.750.330
Fig. 33
Lower Roots
Radici Inferiori



DE.750.331
Fig. 33A
Lower Roots
Radici Inferiori



DE.750.335
Fig. 33M
Lower Roots
Radici Inferiori



DE.750.450
Fig. 45
Lower Roots
Radici Inferiori



DE.750.463
Fig. 46L
Lower Roots
Radici Inferiori



DE.750.510
Fig. 51
Upper Roots
Radici Superiori



DE.750.511
Fig. 51A
Upper Roots / Radici
Superiori



DE.750.515
Fig. 51M
Upper Roots
Radici Superiori



Extraction Estrazione

Extraction Forceps European Pattern / Pinze Per Estrazione Mod. Europeo

750 SERIES Standard Grip / Manico Standard



DE.750.670
Fig. 67
Upper Third Molars
Denti Del Giudizio Superiori

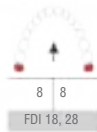

DE.750.671
Fig. 67A
Upper Third Molars
Denti Del Giudizio Superiori



DE.750.730
Fig. 73
Lower Molars
Molari Inferiori

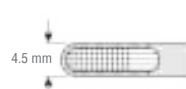
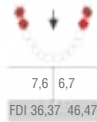

DE.750.740
Fig. 74
Lower Roots
Radici Inferiori



DE.750.743
Fig. 74N
Lower Roots
Radici Inferiori

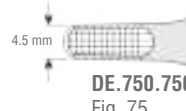

DE.750.750
Fig. 75
Lower Premolars/Bicuspsids
Premolari Inferiori

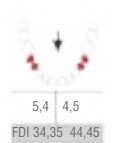

DE.750.790
Fig. 79
Lower Third Molar
Denti Del Giudizio Inferiori



DE.750.861
Fig. 86A
Lower Molars
Molari Inferiori

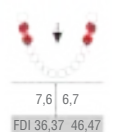

Extraction Forceps European Pattern / Pinze Per Estrazione Mod. Europeo

750 SERIES Standard Grip / Manico Standard



DE.750.863
Fig. 86C
Lower Molars
Molari Inferiori

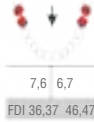

DE.750.870
Fig. 87
Lower Molars
Molari Inferiori

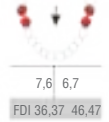

DE.751.450
Fig. 145
Very Fine Roots, Lower
Radici, Molto Fini, Inferiori

1.5 mm



DE.751.510
Fig. 151½
Very Fine Roots, Upper
Radici, Molto Fini, Superiori

1.5 mm



DE.753.490
Fig. 349
Very Fine Roots, Upper
Radici, Molto Fini, Superiori

2.0 mm



DE.753.590
Fig. 359
Very Fine Roots, Lower
Radici, Molto Fini, Inferiori

2.0 mm



DE.750.000
Set of 10 / Serie di 10
Contents / Contenuto:

- DE.750.010** Fig. 1
- DE.750.070** Fig. 7
- DE.750.130** Fig. 13
- DE.750.170** Fig. 17
- DE.750.180** Fig. 18
- DE.750.220** Fig. 22
- DE.750.331** Fig. 33A
- DE.750.511** Fig. 51A
- DE.750.671** Fig. 67A
- DE.750.790** Fig. 79

Extraction Estrazione

Extraction Forceps European Pattern / Pinze Per Estrazione Mod. Europeo

800 SERIES
Anatomical Grip / Manico Anatomico



DE.800.010
Fig. 1
Upper Centrals & Canines/Cuspids
Incisivi e Canini Superiori

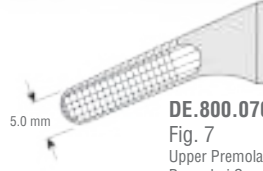

DE.800.070
Fig. 7
Upper Premolars/Bicuspids
Premolari Superiori



DE.800.130
Fig. 13
Lower Premolars/Bicuspids
Premolari Inferiori



DE.800.170
Fig. 17
Upper Molars, Right
Molari Superiori, Destri

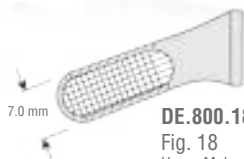

DE.800.180
Fig. 18
Upper Molars, Left
Molari Superiori, Sinistri

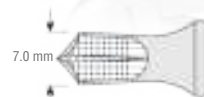

DE.800.220
Fig. 22
Lower Molars
Molari Inferiori

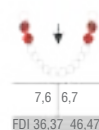

Extraction Forceps European Pattern / Pinze Per Estrazione Mod. Europeo

800 SERIES Anatomical Grip / Manico Anatomico



DE.800.331
Fig. 33A
Lower Roots
Radici Inferiori



DE.800.511
Fig. 51A
Upper Roots
Radici Superiori

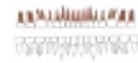

DE.800.671
Fig. 67A
Upper Third Molars
Denti Del Giudizio Superiori

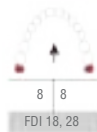

DE.800.790
Fig. 79
Lower Third Molars
Denti Del Giudizio Inferiori



- DE.800.000**
Set of 10 / Serie di 10
Contents / Contenuto:
- DE.800.010** Fig. 1
 - DE.800.070** Fig. 7
 - DE.800.130** Fig. 13
 - DE.800.170** Fig. 17
 - DE.800.180** Fig. 18
 - DE.800.220** Fig. 22
 - DE.800.331** Fig. 33A
 - DE.800.511** Fig. 51A
 - DE.800.671** Fig. 67A
 - DE.800.790** Fig. 79



Extraction Estrazione

Extraction Forceps / Pinze Per Estrazione



DE.881.225
Fig. 122L
Lower Molars, Left
Molari Inferiori, Sinistri



DE.881.227
Fig. 122R
Lower Molars, Right
Molari Inferiori, Destri



DE.898.010
Fig. 1
Witzel
Upper Roots
Radici Superiori



DE.898.020
Fig. 2
Witzel
Lower Roots
Radici Inferiori

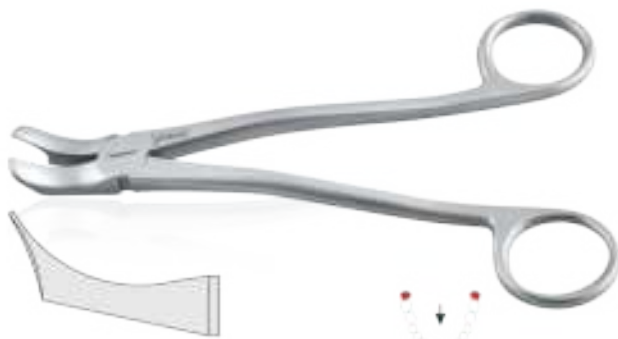

DE.900.010
Fig. 1
Lower Third Molars
Denti Del Giudizio Inferiori

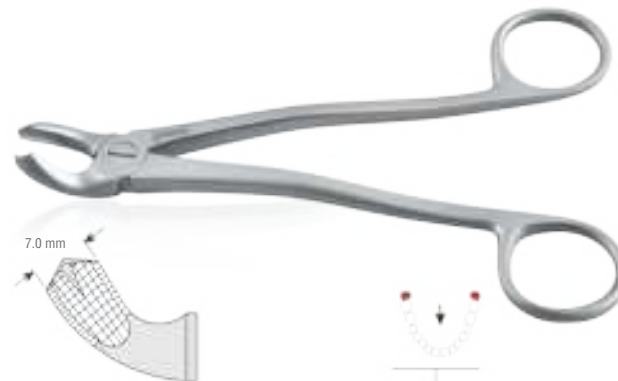

DE.900.020
Fig. 2
Lower Third Molars
Denti Del Giudizio Inferiori



Extraction tweezers / Pinzetta per frammenti



DE.975.010
Fig. 1
Albrecht



DE.975.020
Fig. 2
Albrecht



Dental Surgery
Chirurgia dentale

Retractors / Divaricatori



DS.416.010
Uni. of Minnesota
140 mm



DS.416.011
Minnesota-Simion
135 mm



DS.416.012
Minnesota Serrated
135 mm



DS.416.013
Minnesota-Urban
135 mm



DS.416.030
Cawood-Minnesota
155 mm



DS.416.020
Cawood-Minnesota
145 mm



DS.416.040
Cawood-Minnesota
Müller
165 mm



DS.380.010
Bishop
140 mm



DS.375.020
Austin
Fig. 2



DS.375.100
Austin - Kay



FC.927.180
Boulder Henry
180 mm



FC.920.180
Shepard
180 mm



FC.826.100
Laster
100 mm



FC.833.155
Ward
155 mm



30 x 19 mm

FB.330.150
Kilner
150 mm

33 x 25 mm

Retractors/ Divaricatori



**DS.405.010
Hilger**

Fits any simple stem mouth mirror handle
Adatto per qualsiasi manico per specchietto



**DS.405.000
Hilger**
with handle
con manico



DP.714.010 Small / Piccolo
DP.714.020 Medium / Medio
DP.714.030 Large / Grande
Henahan



**FB.310.200
Falcon**
200 mm



**DS.380.020
Bishop**
150 mm



DS.427.010 100 mm
DS.427.020 105 mm
DS.427.030 115 mm
Oringer

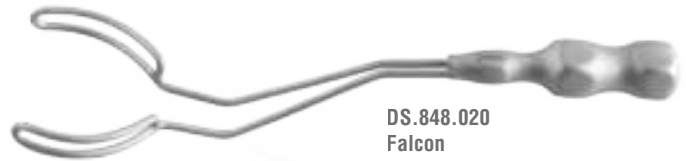

**DS.848.020
Falcon**

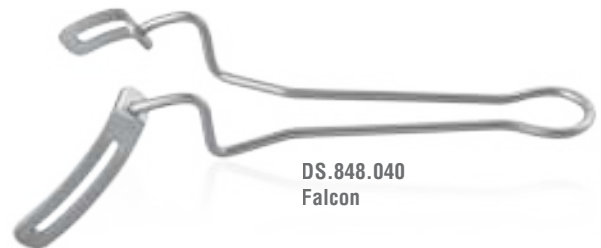

**DS.848.040
Falcon**

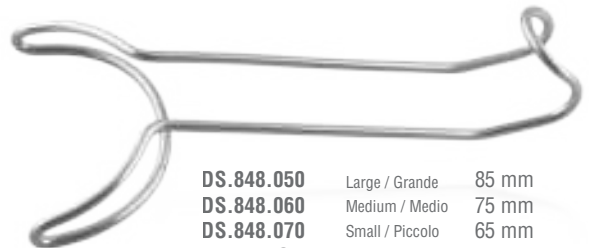

DS.848.050 Large / Grande 85 mm
DS.848.060 Medium / Medio 75 mm
DS.848.070 Small / Piccolo 65 mm
Falcon - Sternberg



**DS.389.145
Columbia**
145 mm



FB.430.010 120 mm
FB.430.020 140 mm
FB.430.030 150 mm
Sternberg



Dental Surgery Chirurgia dentale

Tongue depressors / Abbassalingua



FB.255.145
145 mm



FB.256.180
Buchwald
180 mm



FB.260.190
Bruenings
190 mm



Wieder

30 mm

36 mm



FB.298.010
140 mm



FB.298.020
140 mm

Mouth props, silicone with metal insert Divaricatori in silicone con inserti in metallo



FB.035.010 Small / Piccolo
FB.035.020 Medium / Medio
FB.035.030 Large / Grande

Mouth gags / Apribocca



FB.060.130
Heister
130 mm



FB.065.100 100 mm
FB.065.110 110 mm
FB.065.140 140 mm
Molt



FB.085.160 160 mm
FB.085.190 190 mm
Roser-König

Periodontal chisels / Scalpelli per parodontologia

CLASSIC-LITE
hollow handle
Manico vuoto



DP.028.135 Fig. 13K/TG Kirkland



DP.040.365 Fig. 36/37 Rhodes



DP.078.010 Fig. 1 Ochenbein



DP.078.020 Fig. 2 Ochenbein



DP.085.013 Fig. 1 TG



DP.085.023 Fig. 2 TG

Periodontal files / Lime per parodontologia



DP.345.105 Fig. 9/10 Schluger



DP.347.025 Fig. 1S/2S Sugarman



DP.347.045 Fig. 3S/4S Sugarman



Dental Surgery Chirurgia dentale

Gingivectomy knives / Bisturi per gengivectomia

Classic-Lite hollow handle
Manico vuoto



DP.469.165 Fig. 15/16 Kirkland

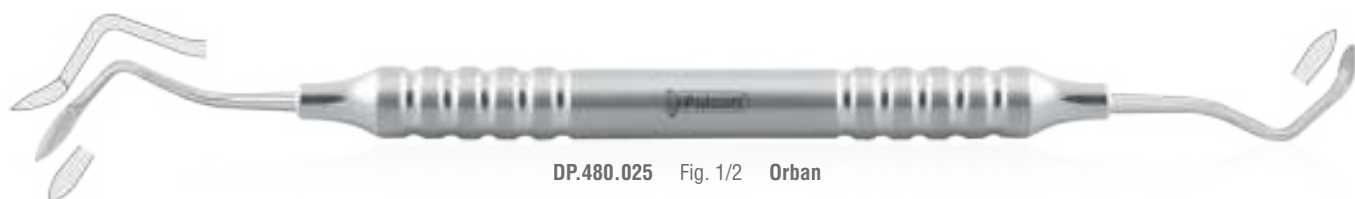

DP.480.025 Fig. 1/2 Orban

Classic Round 6 mm solid handle
Manico pieno da 6mm



DP.469.160 Fig. 15/16 Kirkland



DP.480.020 Fig. 1/2 Orban



DP.500.013 Fig. 1 Orban



DP.500.023 Fig. 2 Orban

Scalpel handles / Manici per bisturi



BK.740.015 Blake



BK.742.015 Falcon 360°

Tunneling instruments

These instruments for vestibular incision subperiosteal tunnel access have been designed for its unique and innovative approach to soft tissue grafting and treatment of recessional defects. TIN coated.

Strumenti per tunneling

Questi strumenti per l'incisione vestibolare e la preparazione del tunnel subperiosteale sono stati disegnati in modo da rappresentare un approccio innovativo per l'innesto del tessuto nel trattamento dei difetti di recessione. Punta rivestite in TIN.



DP.550.015T Fig. V-1



DP.550.025T Fig. V-2



DP.550.035T Fig. V-3



DP.550.045T Fig. V-4



DP.550.055T Fig. V-5



DP.550.065T Fig. V-6



DP.550.000T
Set of 6 pieces /
Serie di 6 pezzi



Dental Surgery Chirurgia dentale

Titanium periosteal elevators / Scollaperiosteali in titanio



DS.832.011 Fig. 1 Busar



DS.839.031 Fig. 3 Prichard

Periosteal Elevators / Scollaperiosteali



DP.666.094 Fig. 9 Molt



DP.665.034 Fig. 3 Prichard



DS.830.091 Fig. 9A Allen



DS.832.015 Fig. 1 Busar



DS.832.025 Fig. 2 Busar



DS.832.035 Fig. 3 Busar



DS.845.015 Fig. 1



DS.845.025 Fig. 2
Sharp-Blunt



DS.838.015 Fig. 1
Atraumatic papilla elevator

Periosteal Elevators / Scollaperiosteali



DP.660.075 Fig. 7 Molt

DP.660.085 Fig. 8 Molt

DP.660.095 Fig. 9 Molt

DP.660.090 Fig. 9 Molt

DP.637.145 Fig. 14 Goldman-Fox

DP.665.035 Fig. 3 Pichard

DP.658.035 Fig. 3 Mead/West

DP.640.205 Fig. 20 Hirschfield

DP.643.015 Fig. 1 Hopkins

DP.643.025 Fig. 2 Hopkins

DP.635.155 Fig. 15 Freer

DP.635.165 Fig. 16 Freer

Dental Surgery Chirurgia dentale

Periosteal Elevators / Scollaperiostei



DP.663.100 Fig. 10 OHL



DP.667.210 Fig. 21 Seldin



DP.667.230 Fig. 23 Seldin



DS.828.250 Fig. 25 170 mm

4.0 mm



DS.198.040 Williger 125 mm

5.0 mm



DS.198.050 Williger 125 mm

5.0 mm



FC.280.050 Williger 160 mm

5.5 mm



FC.730.055 Williger 160 mm

Blunt / Smusso

Gauze packers / Tamponatori



DS.350.017 Luniatschek 2.0 mm



DS.350.027 Luniatschek 3.0 mm

Bone Currettes / Cucchiali alveolari

SOFT LINE INSTRUMENTS
soft and sure grip

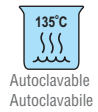

Hemingway



DS.100.014 Fig. 1

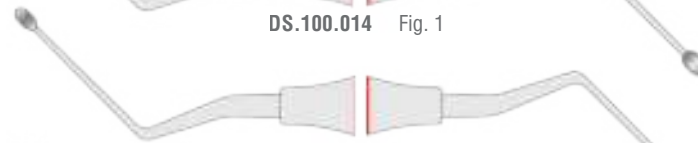

DS.100.024 Fig. 2

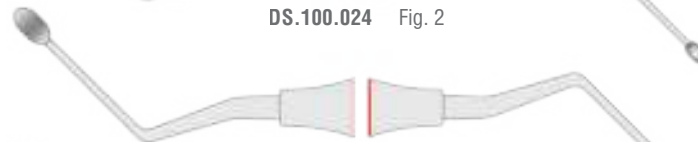

DS.100.034 Fig. 3

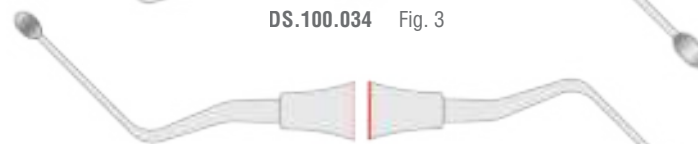

DS.100.044 Fig. 4



Lucas - Serrated

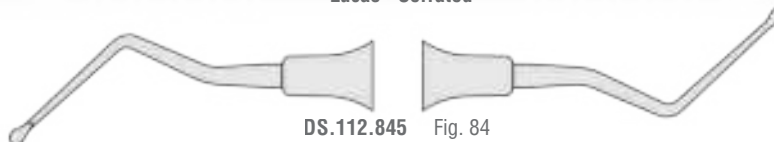

DS.112.845 Fig. 84

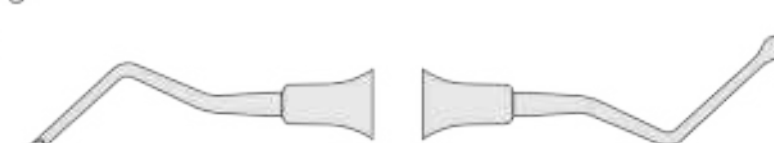

DS.112.855 Fig. 85

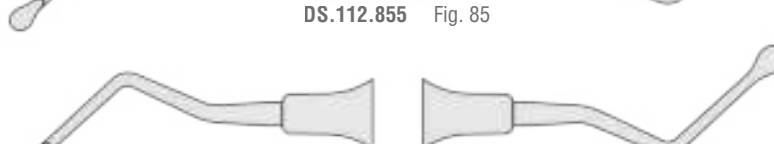

DS.112.865 Fig. 86

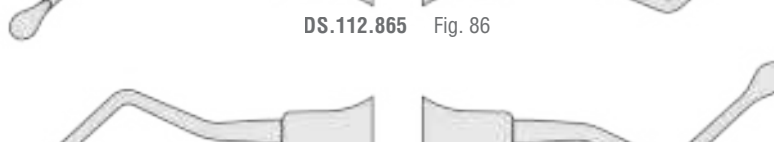

DS.112.875 Fig. 87

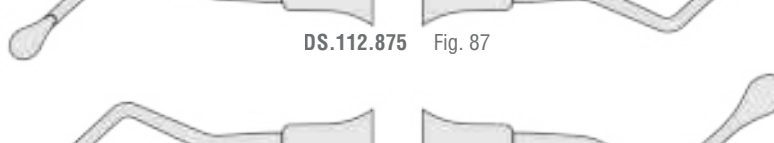

DS.112.885 Fig. 88



Dental Surgery Chirurgia dentale

Bone Currettes / Cucchiari alveolari

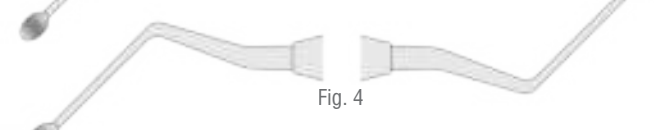
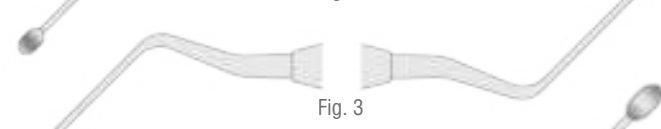
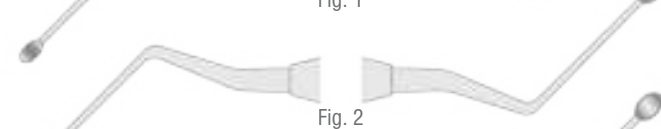
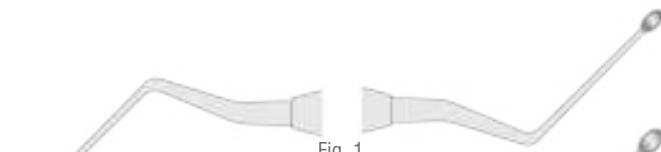

	Classic-Round	Classic-Lite
Fig. 1	DS.100.010	DS.100.015
Fig. 2	DS.100.020	DS.100.025
Fig. 3	DS.100.030	DS.100.035
Fig. 4	DS.100.040	DS.100.045

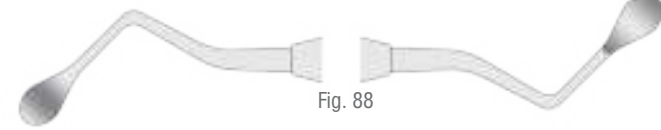
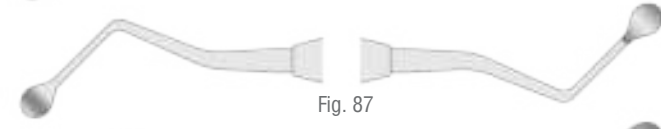
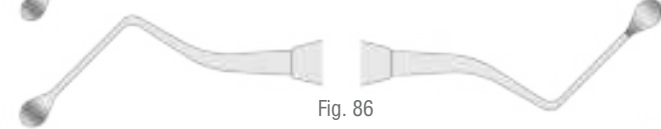
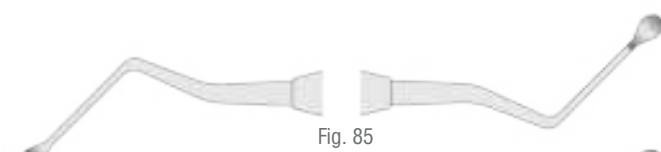

	Classic-Round	Classic-Lite
Fig. 85	DS.110.850	DS.110.855
Fig. 86	DS.110.860	DS.110.865
Fig. 87	DS.110.870	DS.110.875
Fig. 88	DS.110.880	DS.110.885

Bone curettes / Cucchiari alveolari

Classic-8

4.5 mm solid handle
Manico pieno da 4,5 mm

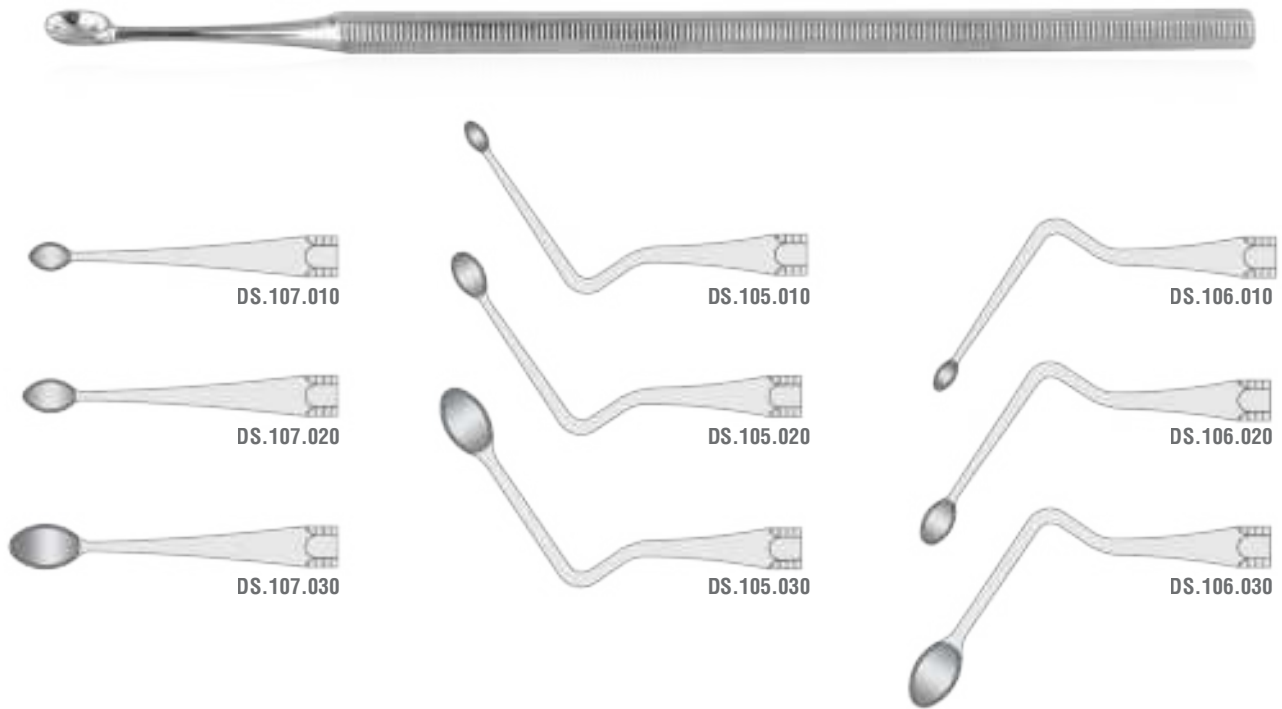

Molt 165 mm

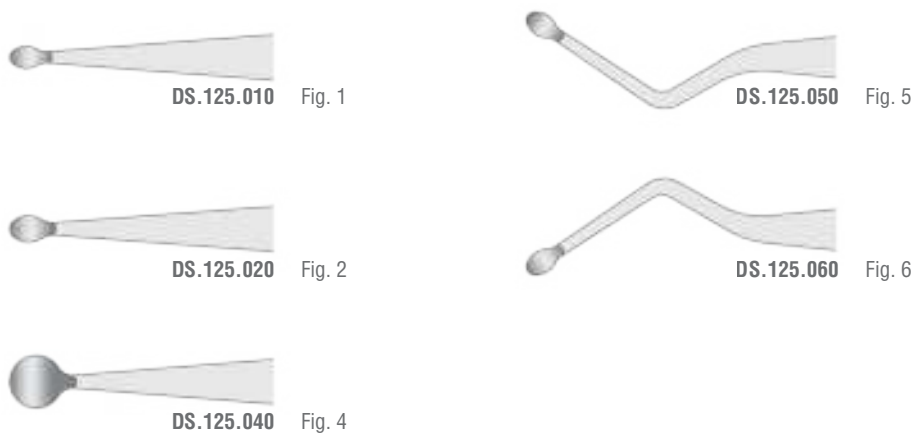

Williger 140 mm



Dental Surgery Chirurgia dentale

Bone files / Lime per osso

CLASSIC-LITE
hollow handle
Manico vuoto



DS.200.100 Fig. 10



DS.200.121 Fig. 12A



DS.200.330 Fig. 33



DS.210.120 Fig. 12 Howard



DS.220.450 Fig. 45 Miller



DS.220.640 Fig. 64 Miller



DS.221.010 Fig. 1 Miller



DS.221.020 Fig. 2 Miller



DS.221.030 Fig. 3 Miller

Bone Rongeurs / Pinze ossivore alveolotome



OR.740.125
Friedmann-Mini
125 mm



OR.742.040
Friedmann-Micro
150 mm



OR.741.140
Friedmann
140 mm



Blumenthal

OR.720.020
150 mm



OR.720.010
150 mm



OR.720.030
145 mm



OR.770.150
Luer
150 mm



OR.775.165
Mead
165 mm

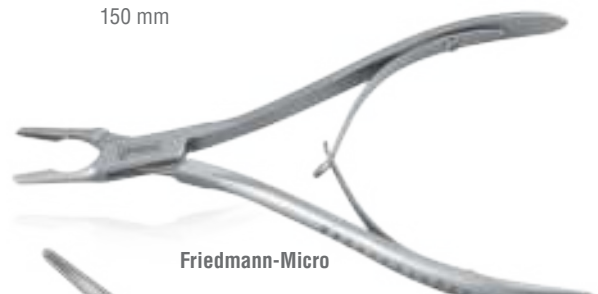

Friedmann-Micro

OR.742.020
150 mm



OR.742.010
150 mm



OR.742.030
145 mm



OR.820.180
Beyer
180 mm



Dental Surgery Chirurgia dentale

Chisels and gouges / Scalpelli e sgorbie



Gardner

DS.055.010
3 mm



DS.055.020
4 mm



Wakefield

DS.070.010
2.7 mm



DS.070.020
3 mm



Partsch 135 mm

OC.450.030
3 mm

OC.450.050
5 mm

OC.450.040
4 mm

OC.450.060
6 mm



Partsch 135 mm

OG.450.030
3 mm

OG.450.050
5 mm

OG.450.040
4 mm

OG.450.060
6 mm

Mallets / Martelli



DS.270.190
Partsch
190 mm



FC.435.010
Spare plastic disks, pair
Coppia dischi di ricambio

FC.435.190
Mead
190 mm



FC.420.010
Spare plastic disks, pair
Coppia dischi di ricambio

FC.420.185
Falcon
185 mm

Bone cutters / Cesioie per osso



DS.503.100
Goldman-Fox
100 mm



OC.850.145
Cleveland
145 mm



DS.508.140
Falcon
Fig. 14
165 mm

Suture forceps / Pinzetta per sutura



DS.650.160
160 mm

Pocket markers / Pinzette per marcare le tasche



DP.705.150
Goldman-Fox
Left / Sinistra



DP.706.150
Goldman-Fox
Right / Destra



Implantology
Implantologia

Implantology Implantologia

Depth measuring probes / Sonde graduate per misurazione

Easy
COLOR



DS.800.010
Titanium tip, silicone handle and laser marked
Punta in titanio, manico in silicone, marcato con laser

Implant caliper / Calibro per implantologia

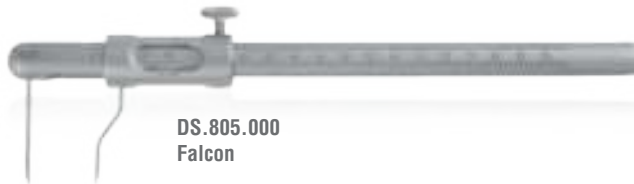

DS.805.000
Falcon

Bone thickness gauges / Spessimetri per osso



DS.804.010
Fig. 1
Castroviejo



DS.804.020
Fig. 2
Castroviejo



DS.804.030
Fig. 3
Castroviejo



DS.804.040
Fig. 4
Castroviejo



DS.804.050
Fig. 5
Castroviejo

Sinus rongeur / Pinza per rialzo del seno

Delicate bone cutting forceps for opening the sinus window 4mm bite, TIN coated
Pinza rivestita in TIN per aprire con delicatezza una finestra nel seno, bite 4 mm.



DS.929.010
Falcon

TIN coated bone block clamps Pinze riposizionatrici di osso rivestite in TIN

To hold and stabilize block graft against recipient site while placing screws.
Slotted tips act as a guide for precise drilling.

Per posizionare e trattenere le membrane in sede durante l'inserimento delle viti.
Le punte scanalate fanno da guida per forare con precisione.



DS.866.010
Anterior / Anteriore



DS.866.020
Posterior / Posteriore

Bone scrapers / Bone scrapers



DS.849.010

Stainless steel, straight, complete with one blade
In acciaio, dritto, completo di una lama



DS.849.020

Stainless steel, curved, complete with one blade
In acciaio, curvo, completo di una lama



DS.849.030

Stainless steel universal blade for straight or curved bone scraper
Lama universale in acciaio per bone scrapers dritto o curvo

Bone well / Raccogliatore per materiale osseo



DS.853.010

Bone mill / Trituratore per osso



Titanium
Titanio

DS.851.040

Titanium / Titanio
Ø 50/40 mm



DS.851.050

Stainless steel / Acciaio
Ø 50/40 mm



DS.851.060

Stainless steel / Acciaio
Ø 45/38 mm

Bone Mill / Trituratore per osso



DS.851.010

Bone injectors / Iniettori per osso



DS.855.011 Fig. 1

DS.855.021 Fig. 2

DS.855.031 Fig. 3

DS.855.041 Fig. 4

Osteotomes / osteotomi

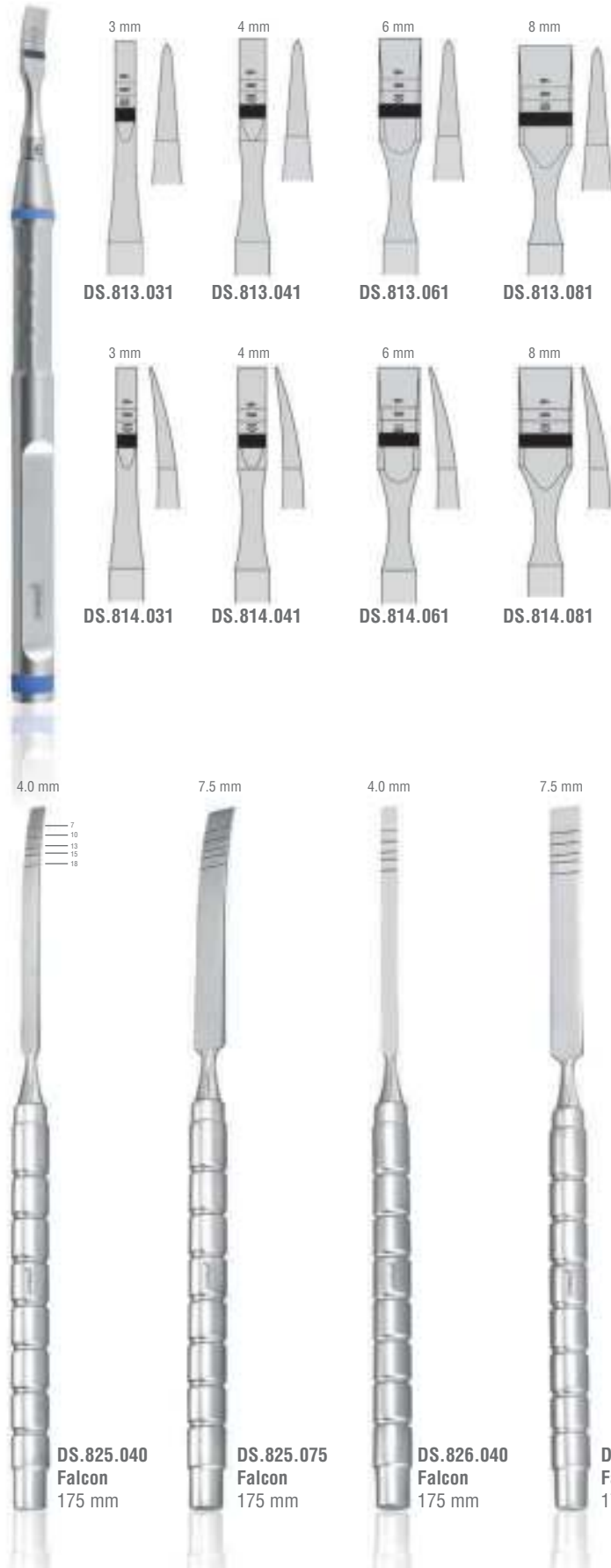

3 mm 4 mm 6 mm 8 mm

DS.813.031 DS.813.041 DS.813.061 DS.813.081

3 mm 4 mm 6 mm 8 mm

DS.814.031 DS.814.041 DS.814.061 DS.814.081

4.0 mm 7.5 mm 4.0 mm 7.5 mm

7
10
13
15
18

DS.825.040 DS.825.075 DS.826.040 DS.826.075

Falcon Falcon Falcon Falcon

175 mm 175 mm 175 mm 175 mm

Mallets / Martelli



Light weight for use with implant osteotomes

Leggeri per uso con osteotomi per implantologia

DS.273.190
Falcon
190 mm

DS.273.010
Spare plastic disks, pair
Coppia dischi di ricambio

DS.273.160
Falcon - Mini
160 mm

DS.273.020
Spare plastic disks, pair
Coppia dischi di ricambio

Bone condensing osteotomes Tapered convex tips

In case of soft bone structure, bone condensers are used for lateral condensation to achieve bone stability in closed sinus elevation technique. Convex tips minimize the risk of perforation when lifting the Schneider's membrane.

Osteotomi per condensare l'osso Punte conico/convesse

I condensatori di osso vengono usati per condensare lateralmente strutture ossee poco consistenti nelle tecniche di rialzo del seno mascellare. Le punte convesse minimizzano il rischio di perforazione durante il rialzo della membrana di Schneider.

Laser marked at 2mm intervals
Intervalli di 2 mm. marcati con Laser

Safety band at 10mm
Indicatore di sicurezza a 10 mm.

Laser marked size
Misura marcata con Laser



● DS.931.022
1.5-2.2 mm

● DS.931.028
2.2-2.8 mm

● DS.931.035
2.8-3.5 mm

● DS.931.042
3.5-4.2 mm

● DS.931.048
4.2-4.8 mm

● DS.936.022
1.5-2.2 mm

● DS.936.028
2.2-2.8 mm

● DS.936.035
2.8-3.5 mm

● DS.936.042
3.5-4.2 mm

● DS.936.048
4.2-4.8 mm



Sinus lift osteotomes Straight concave tips

Used for closed sinus elevation technique, concave semi-sharp tips lift sinus floor and additional bone towards cranial to achieve stable foundation for the placement of implants.

Osteotomi per il rialzo del seno Punte dritte concave

Usati con la tecnica di elevazione del seno 'closed sinus elevation'. Le punte concave semiaffilate asportano particelle di osso che vengono spinte verso l'alto in modo da aumentare il rialzo dello stesso.

Laser marked at 2mm intervals
Intervalli di 2 mm, marcati con Laser

Safety band at 10mm
Indicatore di sicurezza a 10 mm.

Laser marked size
Misura marcata con Laser



● DS.901.022
2.2 mm

● DS.901.028
2.8 mm

● DS.901.035
3.5 mm

● DS.901.042
4.2 mm

● DS.901.048
4.8 mm

● DS.911.022
2.2 mm

● DS.911.028
2.8 mm

● DS.911.035
3.5 mm

● DS.911.042
4.2 mm

● DS.911.048
4.8 mm

Sinus lift instruments / Strumenti per rialzo del seno

CLASSIC-LITE 10 mm hollow handle
Manico vuoto da 10 mm



Sinus lift elevators / Scollatori per rialzo del seno

Sinus lift curettes / Curettes per il rialzo del seno

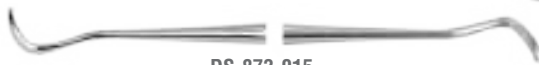

DS.873.015
Fig. 1
Falcon

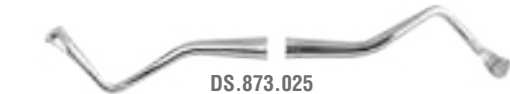

DS.873.025
Fig. 2
Falcon

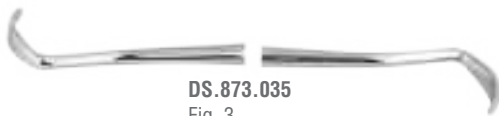

DS.873.035
Fig. 3
Falcon



DS.873.045
Fig. 4
Falcon



DS.873.055
Fig. 5
Falcon

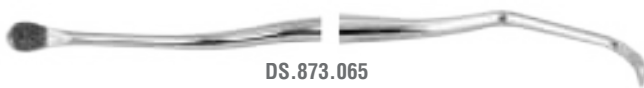

DS.873.065
Fig. 6
Falcon

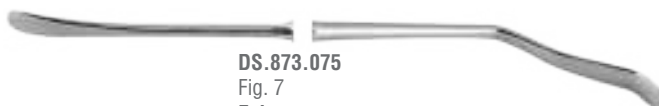

DS.873.075
Fig. 7
Falcon

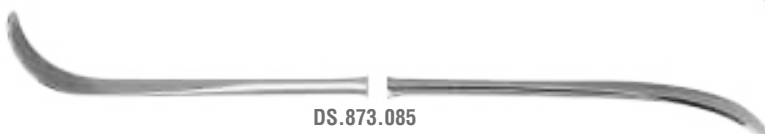

DS.873.085
Fig. 8
Falcon

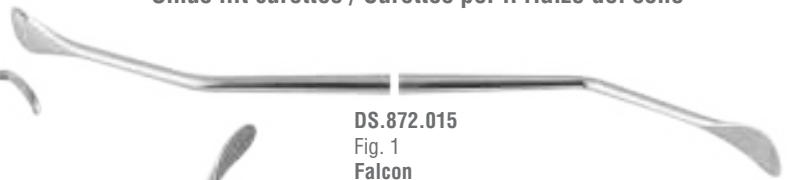

DS.872.015
Fig. 1
Falcon

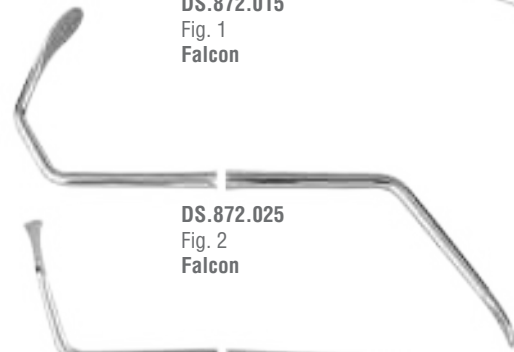

DS.872.025
Fig. 2
Falcon

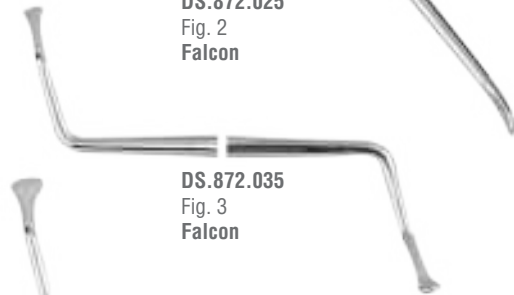

DS.872.035
Fig. 3
Falcon



DS.872.045
Fig. 4
Falcon



DS.872.055
Fig. 5
Falcon

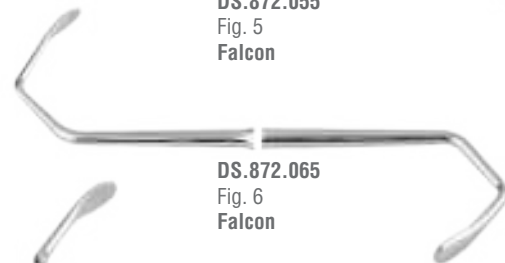

DS.872.065
Fig. 6
Falcon



DS.872.075
Fig. 7
Falcon

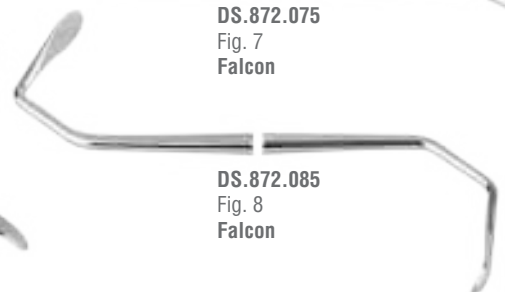

DS.872.085
Fig. 8
Falcon



Implantology Implantologia

Sinus lift instruments / Strumenti per rialzo del seno



DS.874.015T

DS.874.025T

DS.874.035T

DS.874.045T



DS.874.005T
Set of 4 pieces
Conf. 4 pezzi

Applicators for bone grafting material / Applicatori di osso triturato

CLASSIC-LITE 10 mm hollow handle
Manico vuoto da 10 mm



DS.863.015
Applicator / Applicatore



DS.864.015
Applicator and compactor / Applicatore e compattatore

Compactors / Compattatori



DS.865.015



DS.865.025

Membrane placement instruments / Strumenti per il posizionamento della membrana



DS.867.015



DS.868.010
110 mm

Implant scaling instruments / Scaler per implantologia

Easy
COLOR Titanium
Titanium
Titanio

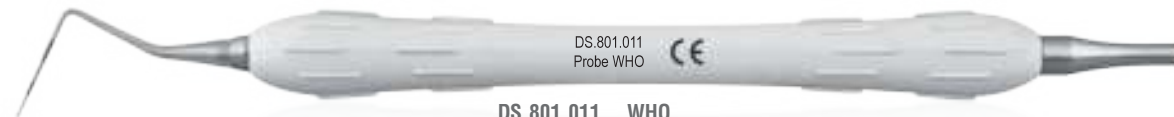

DS.801.011 WHO

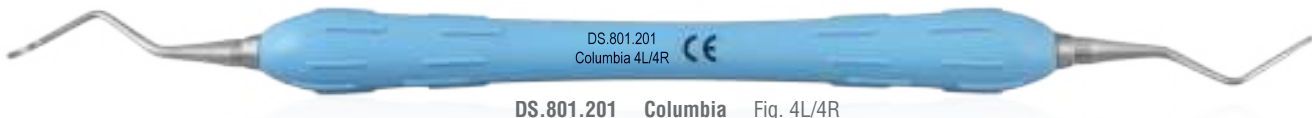

DS.801.201 Columbia Fig. 4L/4R



DS.801.601 Fig. 204S



DS.801.701 Hygienist Fig. 6/7



DS.801.999
Implant scaling instrument kit 4 pieces, one of each type and tray
Scaler per implantologia, kit 4 pezzi + cassette



Soft brushing instruments

The concept of the Soft Brushing is to disorganize the collagen fibers of the fibrous periosteum: the stiffness is reduced and the flap release increases just by using the brushes. The brush tools do not cut anything. The flap release is the result of the separation of the periosteum fibers.

Strumenti per Soft Brushing

Il concetto di 'Soft Brushing' è quello di disorganizzare fibre di collagene del periostio fibroso: questo riduce la rigidità e aumenta il lembo attraverso l'uso di questi strumenti. Gli strumenti soft brushing non tagliano alcunché. Il lembo ottenuto è il risultato della separazione delle fibre del periostio.

DP.980.015T
Fig. 1



DP.980.025T
Fig. 2



DP.980.035T
Fig. 3



DP.980.045T
Fig. 4



DP.980.055T
Fig. 5



DP.980.000T
Set of 5 pieces /
Serie di 5 pezzi



Micro Instruments
Micro strumenti

Micro Instruments

Micro strumenti

Micro scalpel handles / Manici per micro lame

Safety Model



BM.042.100 100 mm
BM.042.130 130 mm



BM.044.100 100 mm



BM.047.130 130 mm

Titanium micro scissors with stainless steel tips Micro forbici in Titanio con lame in acciaio inox

Titanium
Titanio



BM.120.155
155 mm



BM.121.155
155 mm

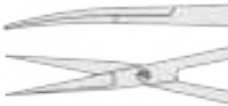

BM.100.180
180 mm



BM.101.180
180 mm

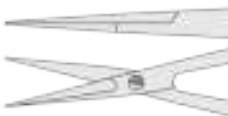

BM.103.180
180 mm



BM.180.150
150 mm



BM.181.150
150 mm

Micro scissors stainless steel / Micro forbici in acciaio inox



BM.180.180
180 mm



BM.181.180
180 mm



BM.183.180
180 mm



Micro scissors for ligature,
one blade serrated
Micro forbici per legature
con una lama zigrinata

Noyes / Castroviejo



BS.504.120
120 mm



BS.505.120
120 mm



BS.506.115
115 mm

Micro forceps / Micro pinzette



BM.420.150
150 mm



BM.421.150
150 mm



BM.420.180
180 mm



BM.421.180
180 mm



BM.470.150
150 mm



BM.471.150
150 mm



BM.470.180
180 mm



BM.471.180
180 mm



BD.904.020
Fig. 2
110 mm



BD.904.050
Fig. 5
110 mm



BD.904.030
Fig. 3
110 mm



BD.904.055
Fig. 5A
110 mm



BD.904.040
Fig. 4
110 mm



BD.904.070
Fig. 7
110 mm



Micro Instruments

Micro strumenti

Titanium micro needle holders

Micro porta aghi in titanio



Titanium needle holders are much lighter compared to their stainless steel equivalent (minus 40%). They are totally corrosion resistant due to lack ferrous elements, they are bio-compatible and are a lot more durable compared to other raw materials.

I porta aghi in Titanio sono molto più leggeri rispetto ai loro equivalenti in acciaio (circa il 40% in meno). Hanno inoltre una particolare resistenza alla corrosione derivante dalla totale assenza di ferro, sono bio-compatibili e hanno una maggiore durata rispetto ai modelli realizzati con altri materiali.



Micro needle holders

Micro porta aghi



With tungsten carbide inserts
Con inserti al carburo di tungsteno

Tungsten Carbide inserts are available in smooth or choice of 3 different serration pitches, for use with different size of suture needles as shown in chart below. Falcon Grip needle holders offer secure grip thus safe guiding of needle.

Con inserti in Carburo di Tungsteno e sono disponibili sia nella versione 'smooth' (punte lisce) che nella versione con punte zigriate con 3 diversi passi a scelta per consentire l'uso di diversi aghi per sutura secondo la tabella che segue.
I porta Aghi Falcon-Grip consentono un' ottima tenuta ed un sicuro controllo dell'ago.

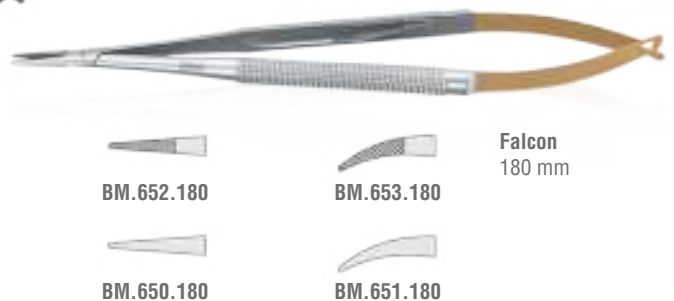
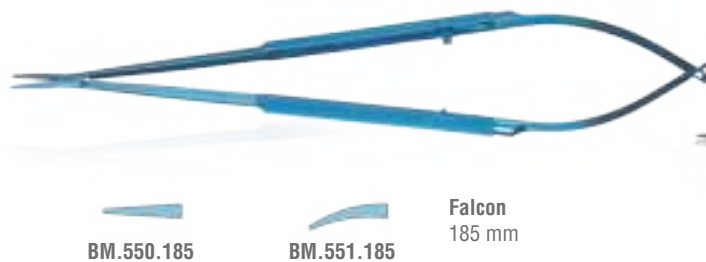

Micro needle holders / Micro porta aghi





Surgery Instruments
Strumenti per chirurgia

Surgery Instruments Strumenti per chirurgia

Scalpel handles / Manici per bisturi

For scalpel blades no / Per le lame no : 10, 11, 12, 12D, 13, 15, 15C



BK.600.050 Fig. 5



BK.610.050 Fig. 5S



BK.612.050 Fig. 5



BK.613.050 Fig. 5A



BK.552.030 Fig. 3G



BK.550.030 Fig. 3



BK.584.070 Fig. 7K



BK.580.070 Fig. 7

For blades no / Per le lame no : 20, 21, 22, 23, 24, 25



BK.650.040 Fig. 4

Scalpels / Bisturi



BK.150.040 35 mm
BK.150.050 40 mm
BK.150.060 45 mm
BK.150.070 50 mm

Scalpel blades / Lame per bisturi

Sterile
Individually packed
Box of 100 pieces

Sterile
Bustina individuale
Conf. 100 pezzi



BK.500.100
Fig. 10



BK.500.110
Fig. 11



BK.500.120
Fig. 12



BK.500.122
Fig. 12D



BK.500.130
Fig. 13



BK.500.150
Fig. 15



BK.500.152
Fig. 15C

Blade remover / Toglilame



BK.750.150
Falcon
150 mm

Scissors with Tungsten Carbide Inserts / Forbici con riporti al carburo di tungsteno

Key Features:

- Extremely smooth cutting with less trauma.
- Manufactured from high quality stainless steel and tungsten carbide inserts for longer-lasting cutting edge.
- Gold plated rings.

Caratteristiche:

- Taglio di precisione atraumatico.
- Realizzate con acciai di elevata qualità e riporti al carburo di tungsteno per mantenere a lungo il taglio.
- Anelli placcati d'oro.



BS.107.115
La Grange
115 mm



DS.601.130

Goldman-Fox
130 mm

DS.600.130

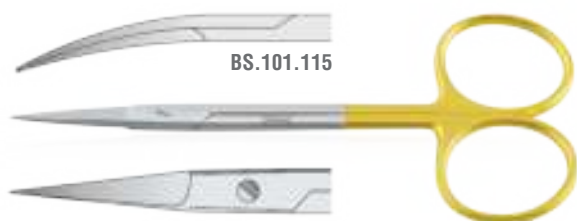

BS.101.115

Iris
115 mm



BS.100.115

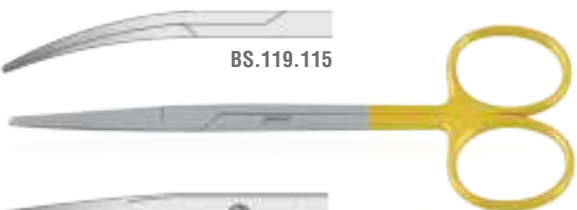

BS.119.115

Strabismus
115 mm



BS.118.115

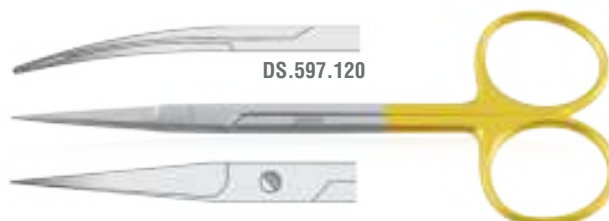

DS.597.120

Falcon
120 mm



DS.596.120



BS.201.145

Metzenbaum
145 mm



BS.200.145



BS.137.160

Kelly
160 mm



BS.136.160



Surgery Instruments Strumenti per chirurgia

Super-Cut Scissors

- Cutting blade horned to "razor" sharpness with opposing blade finished with fine serrations to avoid tissue slippage.
- Extremely smooth cutting with less trauma.

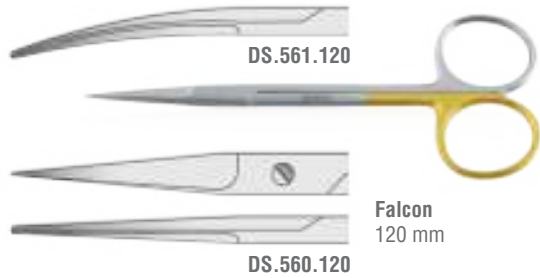
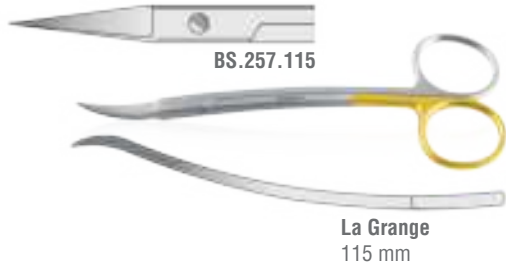

Super-Cut Forbici

- Lama di taglio con affilatura a "rasoio" con controlama finemente zigrinata per evitare scivolamenti del tessuto.
- Taglio di grande precisione e quindi atraumatico.

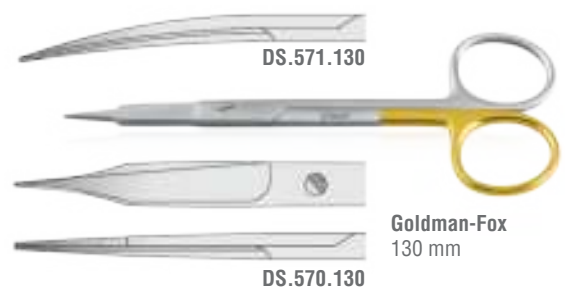
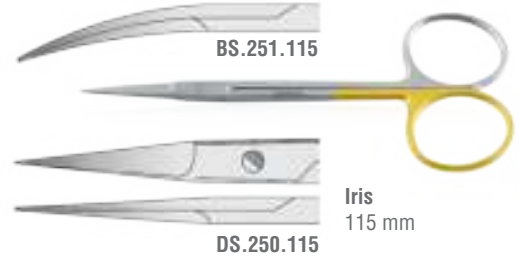

Scissors, One Blade Serrated

- One blade is with fine serrations to avoid tissue or ligature slippage.

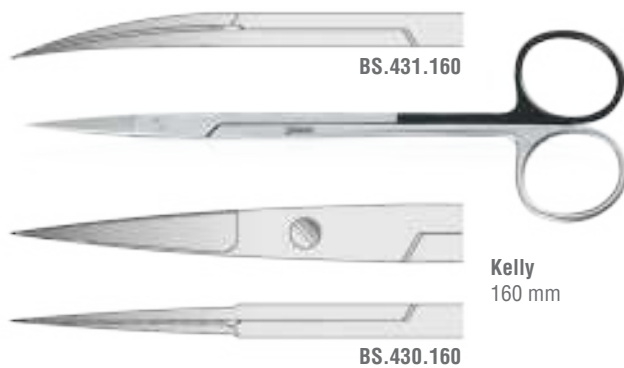

Forbici con Una Lama Zigrinata

- Una lama è rifinita con finissime zigrinature per trattenere il tessuto o la legatura durante il taglio.



Gum and Operating Scissors / Forbici per gengive e chirurgia

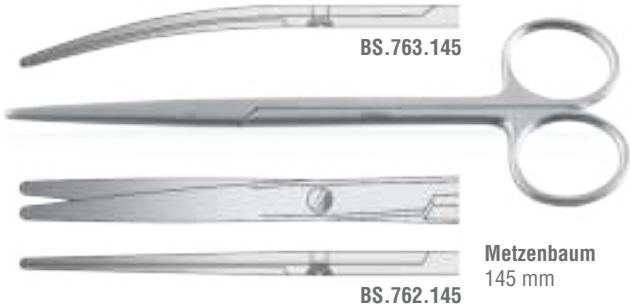
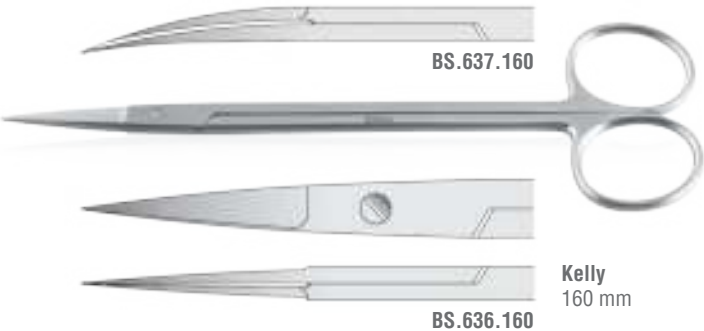
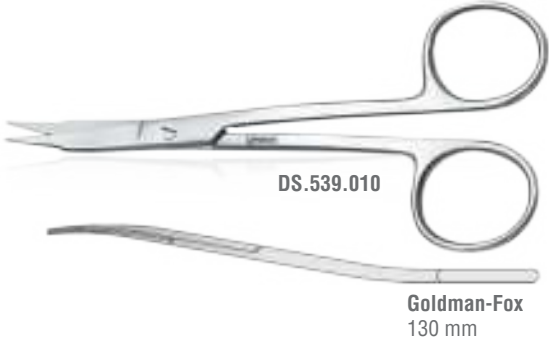
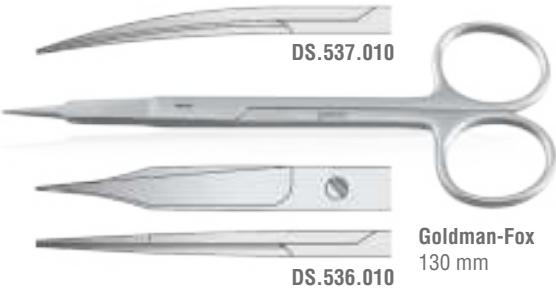

Surgery Instruments Strumenti per chirurgia

Operating scissors / Forbici per chirurgia

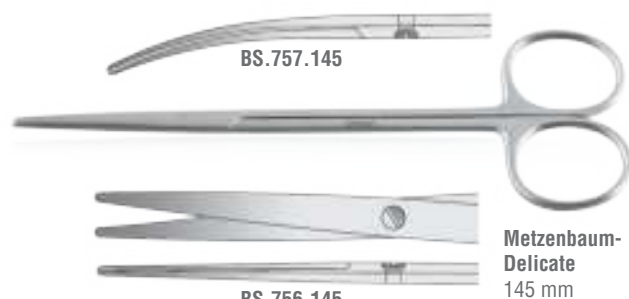

Metzenbaum-Delicate
145 mm

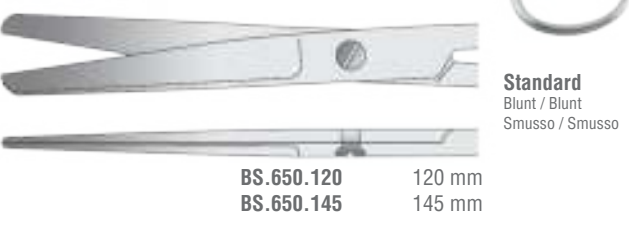
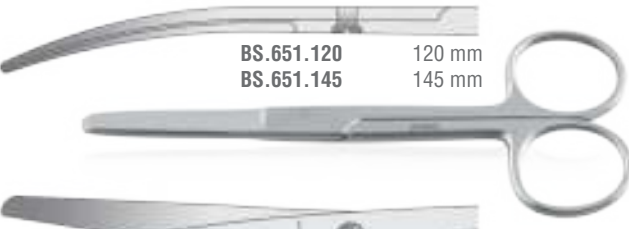

Standard
Blunt / Blunt
Smusso / Smusso

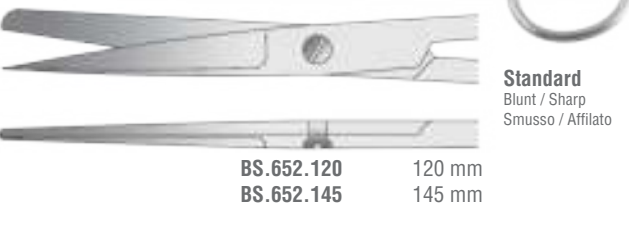
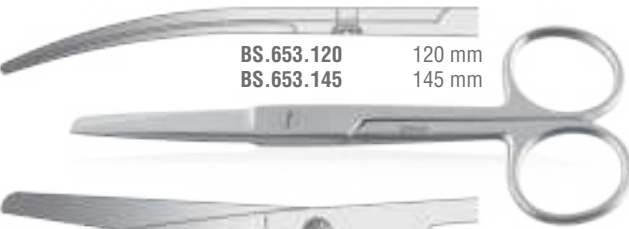

Standard
Blunt / Sharp
Smusso / Affilato

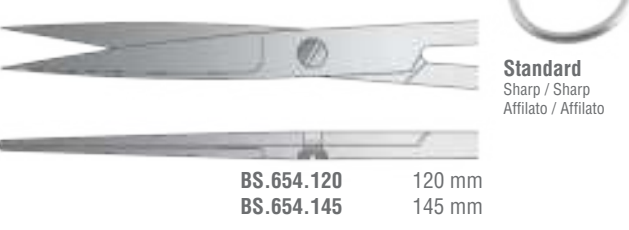

Standard
Sharp / Sharp
Affilato / Affilato

Operating scissors / Forbici per chirurgia



Mayo
145 mm

Suture scissors / Forbici per legature

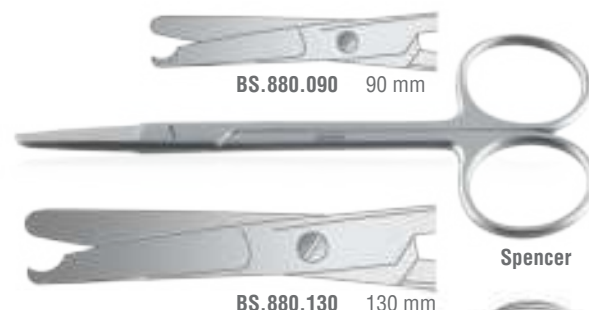

Spencer



Littauer

Bandage scissors / Forbici per bendaggi

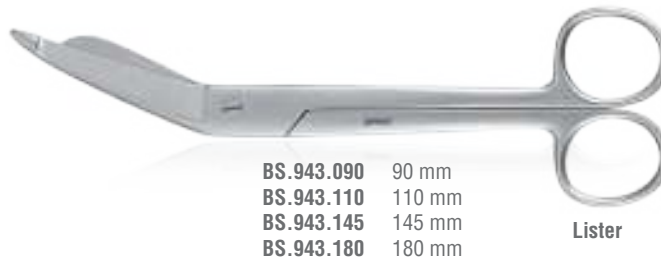

Lister



Forceps atraumatic / Pinzette atraumatiche

Titanium
Titanio



Forceps atraumatic / Pinzette atraumatiche



Dissecting and tissue forceps / Pinzette anatomiche e chirurgiche



Dissecting forceps / Pinzette anatomiche

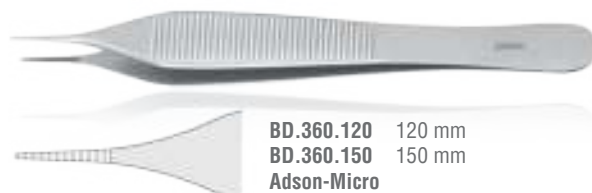
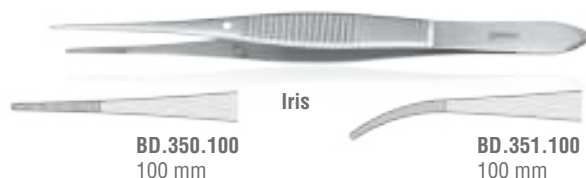

Dissecting and tissue forceps / Pinzette anatomiche e chirurgiche



With tungsten carbide inserts
Con inserti al carburo di tungsteno

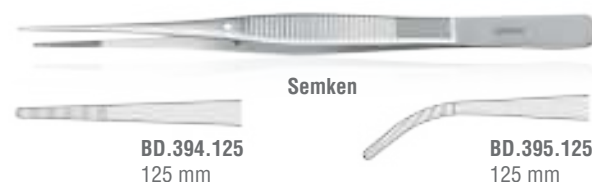
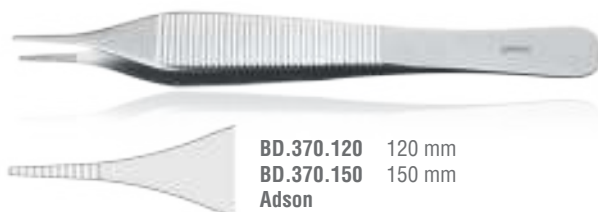

Surgery Instruments Strumenti per chirurgia

Dissecting forceps / Pinzette anatomiche



Gerald

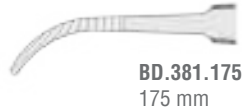
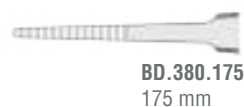

Standard

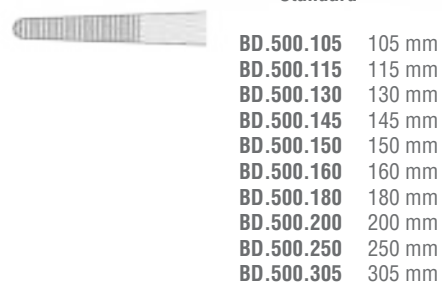

Tissue forceps / Pinzette chirurgiche



Iris



Semken



Tissue forceps / Pinzette chirurgiche



Gerald

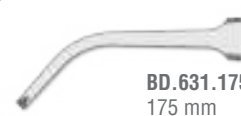

Standard

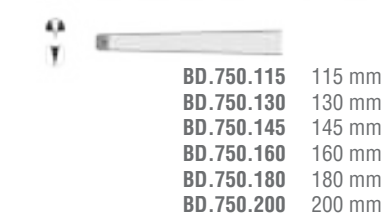

Splinter forceps / Pinze per frammenti

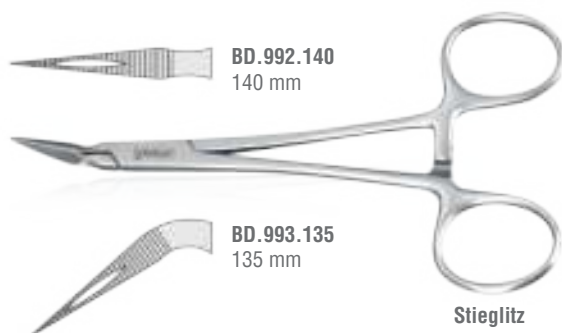

Dressing and sponge forceps / Pinze porta tamponi e spugne

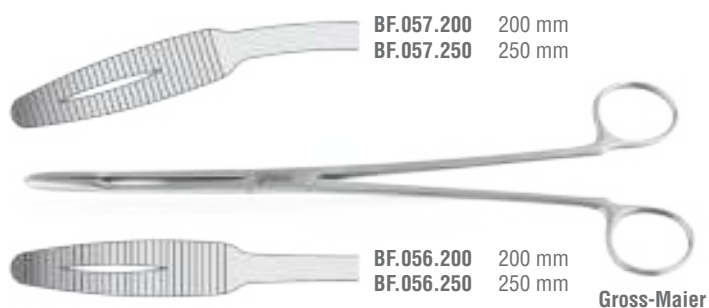
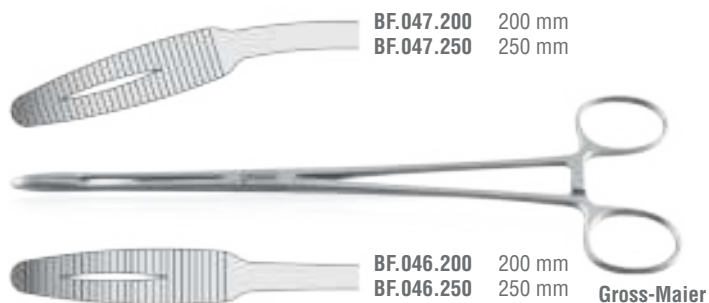

Towel forceps / Pinze per pannolino

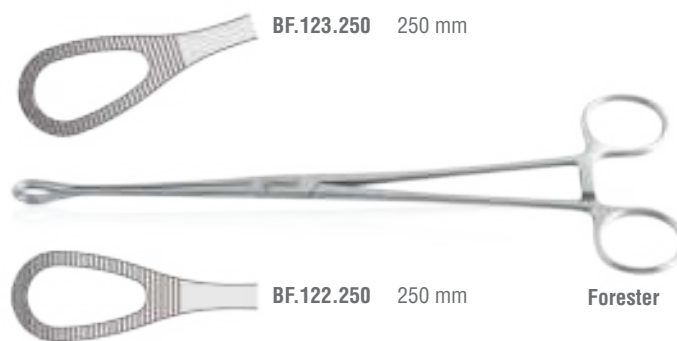
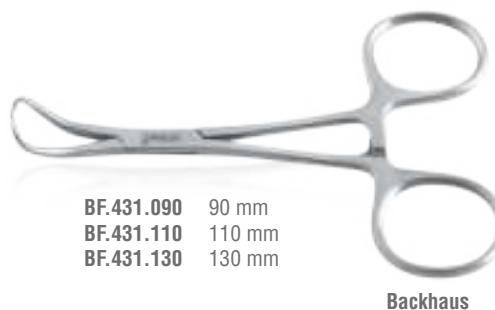

Surgery Instruments Strumenti per chirurgia

Haemostatic Forceps / Pinze emostatiche

BH.211.100

BH.210.100
Hartmann
100 mm

BH.221.125

BH.220.125
Micro Mosquito
125 mm

BH.224.125

BH.225.125

BH.226.125 1 x 2 th

BH.227.125
Halsted-Mosquito
125 mm

BH.267.145

BH.266.145
Kelly
145 mm

BH.271.145

BH.270.145
Crile
145 mm

BH.487.145

BH.486.145
Kocher Delicate
145 mm

BH.301.160

BH.300.160
Kelly-Rankin
160 mm

BH.307.160

BH.306.160
Crile-Rankin
160 mm

BH.331.190

BH.330.190
Adson-Fraser
190 mm

BH.481.165
165 mm

BH.481.145
145 mm

BH.480.145
145 mm

BH.480.165
165 mm

Rochester-Pean

BH.491.145

BH.490.145
Kocher
145 mm

Needle holders / Porta aghih



With tungsten carbide inserts
Con inserti al carburo di tungsteno



BN.151.140



BN.150.140

Castroviejo

5-0, 6-0, 7-0, 8-0, 9-0, 10-0, 11-0
140 mm



BN.153.140



BN.152.140

Castroviejo

5-0, 6-0, 7-0, 8-0, 9-0, 10-0
140 mm



BN.155.140



BN.154.140

Castroviejo

4-0, 5-0, 6-0
140 mm



BN.156.140

Castroviejo

5-0, 6-0, 7-0, 8-0, 9-0, 10-0, 11-0
140 mm



BN.157.140

Castroviejo

5-0, 6-0, 7-0, 8-0, 9-0, 10-0
140 mm



BN.158.140

Castroviejo

4-0, 5-0, 6-0
140 mm



BN.153.180



BN.152.180

Castroviejo

5-0, 6-0, 7-0, 8-0, 9-0, 10-0
180 mm



BN.204.125
125 mm

Derf

3-0, 4-0, 5-0

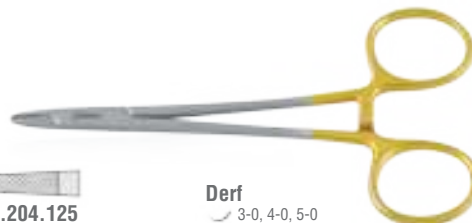

BN.200.130
130 mm

Halsey

3-0, 4-0, 5-0, 6-0



BN.230.150
150 mm

**Swedish-Micro
Vascular**

4-0, 5-0, 6-0

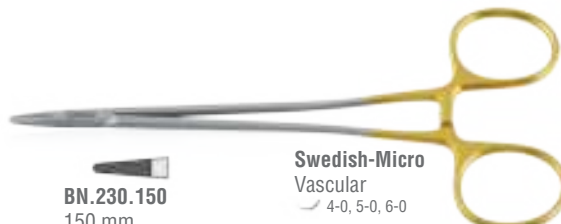

BN.235.150
150 mm

Crilewood

3-0, 4-0, 5-0, 6-0



BN.237.150
150 mm

Crilewood

3-0, 4-0, 5-0, 6-0



BN.236.150
150 mm



BN.236.151
150 mm

Crilewood

3-0, 4-0, 5-0, 6-0



Surgery Instruments Strumenti per chirurgia

Needle holders / Porta aghih



With tungsten carbide inserts
Con inserti al carburo di tungsteno

BN.238.150
150 mm

Baby-Crile-Wood
3-0, 4-0, 5-0, 6-0



BN.290.145
145 mm

Baumgartner
2-0, 3-0, 4-0

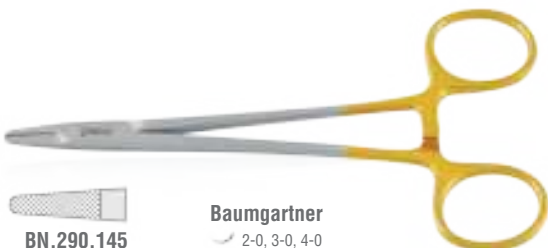

BN.298.130
130 mm

Mayo-Hegar
2-0, 3-0, 4-0, 5-0

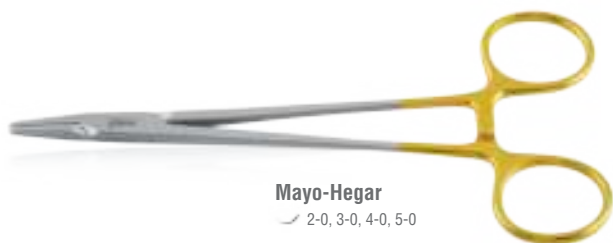

BN.298.160
160 mm

BN.298.140
140 mm

BN.298.180
180 mm

BN.298.150
150 mm

BN.298.200
200 mm

BN.374.140
140 mm

BN.374.170
170 mm

Olsen-Hegar
3-0, 4-0, 5-0



BN.412.140
140 mm



BN.412.170
170 mm

Mathieu-Kocher
2-0, 3-0, 4-0

BN.414.140
140 mm



BN.414.170
170 mm

Mathieu
2-0, 3-0, 4-0

BN.418.140
140 mm



BN.418.170
170 mm

Mathieu
2-0, 3-0, 4-0

BN.431.140
140 mm



BN.431.170
170 mm

Metzenbaum
2-0, 3-0, 4-0

BN.396.180
180 mm

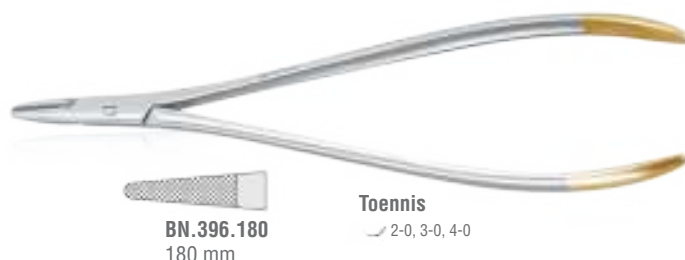

Toennis
2-0, 3-0, 4-0

Needle Holders / Porta aghi

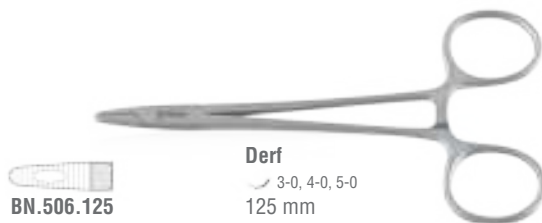

Surgery Instruments Strumenti per chirurgia

Needle holders / Porta aghi



Mayo-Hegar
 2-0, 3-0, 4-0, 5-0

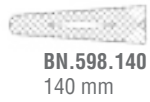

BN.598.140
 140 mm

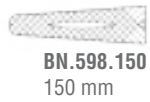

BN.598.150
 150 mm

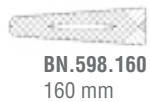

BN.598.160
 160 mm

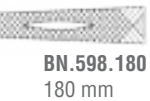

BN.598.180
 180 mm



BN.598.200
 200 mm



Gillies
 2-0, 3-0, 4-0, 5-0, 6-0
 160 mm
 With scissors
 Con forbici

BL.539.160
 Left handed / Sinistro

BN.689.160
 Right handed / Destro



Olsen-Hegar
 3-0, 4-0, 5-0
 140 mm
 With scissors
 Con forbici



BN.674.140

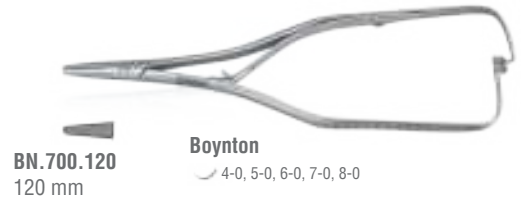

BN.700.120
 120 mm

Boynton
 4-0, 5-0, 6-0, 7-0, 8-0

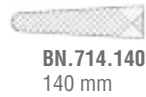

BN.714.140
 140 mm

Mathieu
 2-0, 3-0, 4-0

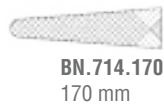

BN.714.170
 170 mm

Mathieu
 2-0, 3-0, 4-0



BN.716.200
 200 mm

Mathieu
 2-0, 3-0, 4-0

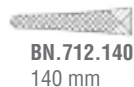

BN.712.140
 140 mm

Mathieu-Kocher
 2-0, 3-0, 4-0

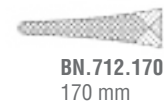

BN.712.170
 170 mm

Mathieu-Kocher
 2-0, 3-0, 4-0

Skin hooks / Uncini cutanei



Kilner

BQ.045.150
150 mm



Gillies

BQ.041.010
180 mm



BQ.041.020
180 mm

Retractors / Divaricatori

Sharp / Affilato



Falcon
160 mm



BQ.103.010



BQ.103.020



BQ.103.030



BQ.103.040

Blunt / Smusso



Falcon
160 mm



BQ.100.010



BQ.100.020



BQ.100.030



BQ.100.040

Retractors / Divaricatori



Senn-Miller
160 mm

Blunt / Smusso



BQ.150.160



Sharp / Affilato



BQ.151.160



BQ.250.120
Farabeuf
120 mm
Pair / Paio



BQ.284.210
Parker-Langenbeck
210 mm
Pair / Paio



Surgery Instruments Strumenti per chirurgia

Retractors / Divaricatori



Langenbeck
220 mm

- BQ.458.010** 30 x 11 mm
- BQ.458.020** 30 x 14 mm
- BQ.458.030** 30 x 16 mm
- BQ.458.040** 40 x 11 mm
- BQ.458.050** 50 x 11 mm



Kocher-Langenbeck
215 mm

- BQ.468.050** 40 x 11 mm
- BQ.468.060** 50 x 11 mm



Kocher-Langenbeck
215 mm

- BQ.472.050** 40 x 11 mm
- BQ.472.060** 50 x 11 mm



Middeldorph

- BQ.680.010** 14 x 17 mm, 215 mm
- BQ.680.020** 20 x 22 mm, 220 mm
- BQ.680.030** 26 x 30 mm, 235 mm

Self-Retaining retractors / Divaricatori autostatici



- BR.040.070** Blunt / Smusso **Alm**
- BR.041.070** Sharp / Affilato **70 mm**



- BR.074.135** Blunt / Smusso
- BR.077.135** Sharp / Affilato
- Weitlaner**
135 mm

Probes / Sonde

Ø 1.0 mm

- BP.050.145**
145 mm

Ø 2.0 mm

- BP.055.145**
145 mm



**Impression
Porta Impronte**

Impression Porta Impronte

Bite gauge / Calibro facciale

A simple measuring instrument as an aid in the re-establishment of correct facial contour during full or partial denture work.

Un semplice strumento di misura che aiuta a ripristinare il corretto assetto facciale nella esecuzione di protesi parziali o totali.

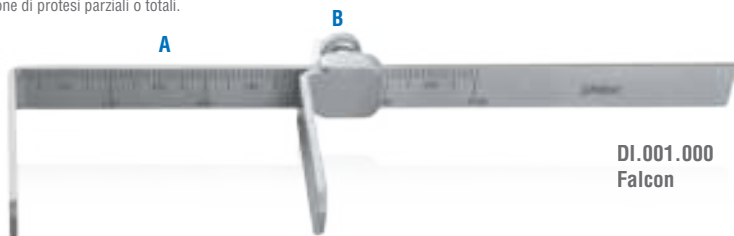

DI.001.000
Falcon

Slide **B** is fully adjustable and reversible along shaft **A** and may be fixed in any position by means of its locking-screw as shown.

il cursore **B** può essere aggiustato e invertito rispetto all'asse **A** e quindi fissato in posizione mediante una vite di bloccaggio come illustrato di seguito.

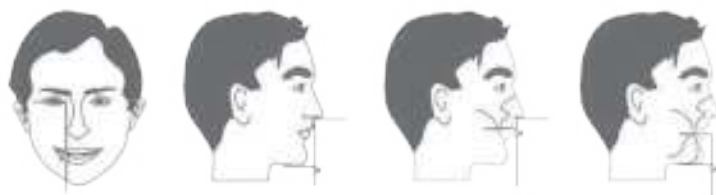

Bite plane / Piano di occlusione



DI.002.000
Fox

Gingival cord packers / Strumenti per filo retrattore



DI.004.015
Fischer
Serrated / Zigrinato



DI.004.025
Fischer
Serrated / Zigrinato

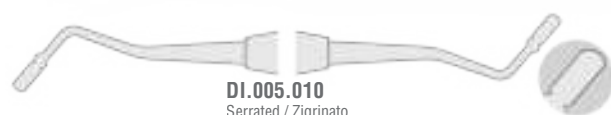

DI.005.010
Serrated / Zigrinato



DI.009.010
Serrated / Zigrinato



DI.005.020
Smooth / Liscio



DI.006.020
Serrated / Zigrinato

Carvers for silicone impression materials / Strumento per modellare impronte in silicone



DI.010.017

Impression Trays / Porta Impronte

D-Color

Impression trays regular / Porta impronte tipo regular

- Color Coded for easy identification of size
 - Micro etched inner surface for better retention
 - Available perforated or solid
- Identificazione della misura attraverso il colore
 - Superfici interne microruvide per maggiore ritenzione
 - In allestimento perforato o liscio.



Autoclavable
Autoclavabile



Perforated with rim / Perforate con bordo ritentivo

Lower / Inferiori



DI.801.010
L1 / XL
Purple / Porpora



DI.801.020
L2 / L
Green / Verde



DI.801.030
L3 / M
Blue / Blu



DI.801.040
L4 / S
Red / Rosso



DI.801.050
L5 / XS
Yellow / Gialla



DI.851.060
Set of 6 pieces / Serie di 6 pezzi

Upper / Superiori



DI.811.010
U1 / XL
Purple / Porpora



DI.811.020
U2 / L
Green / Verde



DI.811.030
U3 / M
Blue / Blu



DI.811.040
U4 / S
Red / Rosso



DI.811.050
U5 / XS
Yellow / Gialla



DI.851.000
Set of 10 pieces / Serie di 10 pezzi

Solid with rim / Lisce con bordo ritentivo

Lower / Inferiori



DI.821.010
L1 / XL
Purple / Porpora



DI.821.020
L2 / L
Green / Verde



DI.821.030
L3 / M
Blue / Blu



DI.821.040
L4 / S
Red / Rosso



DI.821.050
L5 / XS
Yellow / Gialla



DI.861.060
Set of 6 pieces / Serie di 6 pezzi

Upper / Superiori



DI.831.010
U1 / XL
Purple / Porpora



DI.831.020
U2 / L
Green / Verde



DI.831.030
U3 / M
Blue / Blu



DI.831.040
U4 / S
Red / Rosso



DI.831.050
U5 / XS
Yellow / Gialla



DI.861.000
Set of 10 pieces / Serie di 10 pezzi

Impression Porta Impronte

D-Color

Impression trays regular / Porta impronte tipo regular



Autoclavabile
Autoclavabile

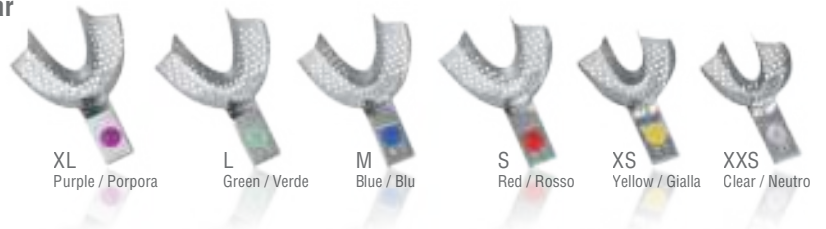

XL
Purple / Porpora

L
Green / Verde

M
Blue / Blu

S
Red / Rosso

XS
Yellow / Gialla

XXS
Clear / Neutro

Perforated without rim / Perforate senza bordo ritentivo

Perforated with rim / Perforate con bordo ritentivo

Lower / Inferiori

Lower / Inferiori

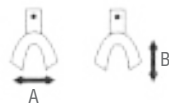

No.	Size	A mm	B mm	Code / Codice
L1	XXS	55	47	DI.701.010
L2	XS	60	49	DI.701.020
L3	S	72	54	DI.701.030
L4	M	74	57	DI.701.040
L5	L	76	59	DI.701.050
L6	XL	78	61	DI.701.060

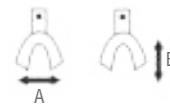

No.	Size	A mm	B mm	Code / Codice
L1	XXS	55	47	DI.751.010
L2	XS	60	49	DI.751.020
L3	S	72	54	DI.751.030
L4	M	74	57	DI.751.040
L5	L	76	59	DI.751.050
L6	XL	78	61	DI.751.060

Upper / Superiori

Upper / Superiori



No.	Size	A mm	B mm	Code / Codice
U1	XXS	61	47	DI.706.010
U2	XS	64	51	DI.706.020
U3	S	66	53	DI.706.030
U4	M	69	57	DI.706.040
U5	L	71	60	DI.706.050
U6	XL	73	62	DI.706.060

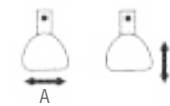

No.	Size	A mm	B mm	Code / Codice
U1	XXS	61	47	DI.756.010
U2	XS	64	51	DI.756.020
U3	S	66	53	DI.756.030
U4	M	69	57	DI.756.040
U5	L	71	60	DI.756.050
U6	XL	73	62	DI.756.060



Set	Contents / Contenuto	Code / Codice
6 pieces/pezzi	L3,L4,L5,U3,U4,U5	DI.721.060
8 pieces/pezzi	L3,L4,L5,L6,U3,U4,U5,U6	DI.721.080
12 pieces/pezzi	L1,L2,L3,L4,L5,L6,U1,U2,U3,U4,U5,U6	DI.721.000

Set	Contents / Contenuto	Code / Codice
6 pieces/pezzi	L3,L4,L5,U3,U4,U5	DI.771.060
8 pieces/pezzi	L3,L4,L5,L6,U3,U4,U5,U6	DI.771.080
12 pieces/pezzi	L1,L2,L3,L4,L5,L6,U1,U2,U3,U4,U5,U6	DI.771.000

Solid without rim / Lisce senza bordo ritentivo

Solid with rim / Lisce con bordo ritentivo

Lower / Inferiori

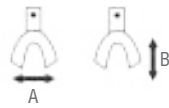

No.	Size	A mm	B mm	Code / Codice
L1	XXS	55	47	DI.711.010
L2	XS	60	49	DI.711.020
L3	S	72	54	DI.711.030
L4	M	74	57	DI.711.040
L5	L	76	59	DI.711.050
L6	XL	78	61	DI.711.060

Lower / Inferiori

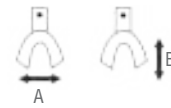

No.	Size	A mm	B mm	Code / Codice
L1	XXS	55	47	DI.761.010
L2	XS	60	49	DI.761.020
L3	S	72	54	DI.761.030
L4	M	74	57	DI.761.040
L5	L	76	59	DI.761.050
L6	XL	78	61	DI.761.060

Upper / Superiori

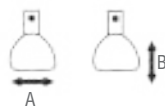

No.	Size	A mm	B mm	Code / Codice
U1	XXS	61	47	DI.716.010
U2	XS	64	51	DI.716.020
U3	S	66	53	DI.716.030
U4	M	69	57	DI.716.040
U5	L	71	60	DI.716.050
U6	XL	73	62	DI.716.060

Upper / Superiori

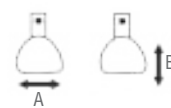

No.	Size	A mm	B mm	Code / Codice
U1	XXS	61	47	DI.766.010
U2	XS	64	51	DI.766.020
U3	S	66	53	DI.766.030
U4	M	69	57	DI.766.040
U5	L	71	60	DI.766.050
U6	XL	73	62	DI.766.060

Set	Contents / Contenuto	Code / Codice
6 pieces/pezzi	L3,L4,L5,U3,U4,U5	DI.726.060
8 pieces/pezzi	L3,L4,L5,L6,U3,U4,U5,U6	DI.726.080
12 pieces/pezzi	L1,L2,L3,L4,L5,L6,U1,U2,U3,U4,U5,U6	DI.726.000

Set	Contents / Contenuto	Code / Codice
6 pieces/pezzi	L3,L4,L5,U3,U4,U5	DI.781.060
8 pieces/pezzi	L3,L4,L5,L6,U3,U4,U5,U6	DI.781.080
12 pieces/pezzi	L1,L2,L3,L4,L5,L6,U1,U2,U3,U4,U5,U6	DI.781.000

D-Color

Silicone buttons for impression trays / Bottoni in silicone per porta impronte

Fit any impression tray, easy identification of size
Adatti per qualsiasi modello in metallo Facilitano l'identificazione della misura



DI.999.000
Assorted pack of 24 buttons
6 colors, 4 of each color
Confezione di 24 colori assortiti,
6 colori/4 di ciascun colore

Impression Porta Impronte

Impression trays regular / Porta impronte tipo regular

Perforated with rim / Perforate con bordo ritentivo

Lower / Inferiori



No.	Size	A mm	B mm	Code / Codice
L1	XL	80	63	DI.800.010
L2	L	78	59	DI.800.020
L3	M	76	57	DI.800.030
L4	NM	72	57	DI.800.040
L5	S	69	50	DI.800.050

Upper / Superiori

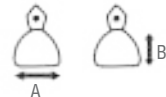

No.	Size	A mm	B mm	Code / Codice
U1	XL	81	63	DI.810.010
U2	L	74	60	DI.810.020
U3	M	71	55	DI.810.030
U4	NM	67	53	DI.810.040
U5	S	65	51	DI.810.050

Set	Contents / Contenuto	Code / Codice
6 pieces/pezzi	L2,L3,L4,U2,U3,U4	DI.850.060
10 pieces/pezzi	L1,L2,L3,L4,L5 U1,U2,U3,U4,U5	DI.850.000

Solid with rim / Lisce con bordo ritentivo

Lower / Inferiori



No.	Size	A mm	B mm	Code / Codice
L1	XL	80	63	DI.820.010
L2	L	78	59	DI.820.020
L3	M	76	57	DI.820.030
L4	NM	72	57	DI.820.040
L5	S	69	50	DI.820.050

Upper / Superiori

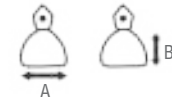

No.	Size	A mm	B mm	Code / Codice
U1	XL	81	63	DI.830.010
U2	L	74	60	DI.830.020
U3	M	71	55	DI.830.030
U4	NM	67	53	DI.830.040
U5	S	65	51	DI.830.050

Set	Contents / Contenuto	Code / Codice
6 pieces/pezzi	L2,L3,L4,U2,U3,U4	DI.860.060
10 pieces/pezzi	L1,L2,L3,L4,L5 U1,U2,U3,U4,U5	DI.860.000

Impression trays for children / Porta impronte per bambini

Perforated with rim / Perforate con bordo ritentivo

Lower / Inferiori



No.	Size	A mm	B mm	Code / Codice
L1	S	54	47	DI.200.010
L2	M	62	51	DI.200.020
L3	L	70	55	DI.200.030

Upper / Superiori



No.	Size	A mm	B mm	Code / Codice
U1	S	55	43	DI.210.010
U2	M	60	45	DI.210.020
U3	L	63	49	DI.210.030

Set	Contents / Contenuto	Code / Codice
6 pieces/pezzi	L1,L2,L3,U1,U2,U3	DI.250.000

Solid with rim / Lisce con bordo ritentivo

Lower / Inferiori



No.	Size	A mm	B mm	Code / Codice
L1	S	54	47	DI.220.010
L2	M	62	51	DI.220.020
L3	L	70	55	DI.220.030

Upper / Superiori

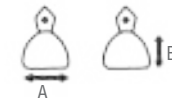

No.	Size	A mm	B mm	Code / Codice
U1	S	55	43	DI.230.010
U2	M	60	45	DI.230.020
U3	L	63	49	DI.230.030

Set	Contents / Contenuto	Code / Codice
6 pieces/pezzi	L1,L2,L3,U1,U2,U3	DI.260.000

Impression trays regular Ehrlicke pattern perforated / Porta impronte tipo regular mod. Ehrlicke

Lower / Inferiori



No.	Size	A mm	B mm	Code / Codice
UB0	XS	65	46	DI.600.000
UB1	S	67	50	DI.600.010
UB2	M	76	54	DI.600.020
UB3	L	79	56	DI.600.030
UB4	XL	79	61	DI.600.040

Set	Contents / Contenuto	Code / Codice
10 pieces/pezzi	UB0,UB1,UB2,UB3,UB4 OB0,OB1,OB2,OB3,OB4	DI.640.000

Upper / Superiori



No.	Size	A mm	B mm	Code / Codice
OB0	XL	59	52	DI.610.000
OB1	L	66	52	DI.610.010
OB2	M	71	62	DI.610.020
OB3	NM	71	64	DI.610.030
OB4	S	80	70	DI.610.040

Impression trays edentulous / Porta impronte edentule

Perforated with rim / Perforate con bordo ritentivo

Lower / Inferiori

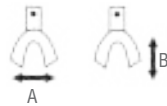

No.	Size	A mm	B mm	Code / Codice
L1	XL	84	65	DI.300.010
L2	L	77	64	DI.300.020
L3	M	76	60	DI.300.030
L4	S	68	57	DI.300.040

Upper / Superiori

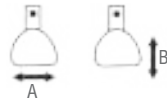

No.	Size	A mm	B mm	Code / Codice
U1	XL	80	62	DI.310.010
U2	L	77	60	DI.310.020
U3	M	70	60	DI.310.030
U4	S	72	56	DI.310.040

Set	Contents / Contenuto	Code / Codice
8 pieces/pezzi	L1,L2,L3,L4, U1,U2,U3,U4	DI.350.000

Solid with rim / Lisce con bordo ritentivo

Lower / Inferiori

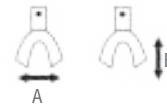

No.	Size	A mm	B mm	Code / Codice
L1	XL	84	65	DI.320.010
L2	L	77	64	DI.320.020
L3	M	76	60	DI.320.030
L4	S	68	57	DI.320.040

Upper / Superiori

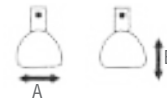

No.	Size	A mm	B mm	Code / Codice
U1	XL	80	62	DI.330.010
U2	L	77	60	DI.330.020
U3	M	70	60	DI.330.030
U4	S	72	56	DI.330.040

Set	Contents / Contenuto	Code / Codice
8 pieces/pezzi	L1,L2,L3,L4, U1,U2,U3,U4	DI.360.000

Impression trays anterior depressed / Porta impronte deprese anteriormente

Perforated with rim / Perforate con bordo ritentivo

Lower / Inferiori

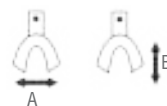

No.	Size	A mm	B mm	Code / Codice
L1	S	65	48	DI.500.010
L2	M	72	57	DI.500.020
L3	L	75	57	DI.500.030

Upper / Superiori

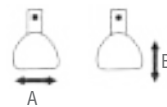

No.	Size	A mm	B mm	Code / Codice
U1	S	64	56	DI.510.010
U2	M	67	60	DI.510.020
U3	L	72	63	DI.510.030

Set	Contents / Contenuto	Code / Codice
6 pieces/pezzi	L1,L2,L3,U1,U2,U3	DI.550.000

Solid with rim / Lisce con bordo ritentivo

Lower / Inferiori

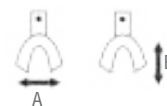

No.	Size	A mm	B mm	Code / Codice
L1	S	65	48	DI.520.010
L2	M	72	57	DI.520.020
L3	L	75	57	DI.520.030

Upper / Superiori

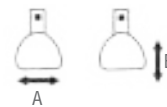

No.	Size	A mm	B mm	Code / Codice
U1	S	64	56	DI.530.010
U2	M	67	60	DI.530.020
U3	L	72	63	DI.530.030

Set	Contents / Contenuto	Code / Codice
6 pieces/pezzi	L1,L2,L3,U1,U2,U3	DI.560.000

Impression trays edentulous Ehricke pattern perforated / Porta impronte Edentule perforate mod. Ehricke

Lower / Inferiori

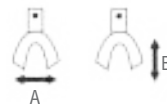

No.	Size	A mm	B mm	Code / Codice
UU1	S	70	48	DI.400.010
UU2	M	70	53	DI.400.020
UU3	L	72	57	DI.400.030

Set	Contents / Contenuto	Code / Codice
6 pieces/pezzi	UU1,UU2,UU3, OU1,OU2,OU3	DI.450.000

Upper / Superiori

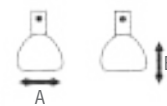

No.	Size	A mm	B mm	Code / Codice
OU1	S	64	46	DI.410.010
OU2	M	68	53	DI.410.020
OU3	L	79	61	DI.410.030

Set	Contents / Contenuto	Code / Codice
6 pieces/pezzi	UU1,UU2,UU3, OU1,OU2,OU3	DI.450.000

Impression Porta Impronte

Partial Impression Trays for Crown and Bridge Work / Porta Impronte Parziale Per Ponti e Corone Perforated with rim / Perforate con bordo ritentivo



DI.900.300
Fig. 30
Upper left / Lower right
Superiore sinistra / Inferiore destra



DI.900.310
Fig. 31
Lower left / Upper right
Inferiore sinistra / Superiore destra



DI.900.320
Fig. 32
Lower jaw
Inferiore



DI.900.330
Fig. 33
Upper jaw
Superiore



DI.900.990
Fig. 99
Lateral
Laterale

Solid with rim / Lisce con bordo ritentivo



DI.905.300
Fig. 30
Upper left / Lower right
Superiore sinistra / Inferiore destra



DI.905.310
Fig. 31
Lower left / Upper right
Inferiore sinistra / Superiore destra



DI.905.320
Fig. 32
Lower jaw
Inferiore



DI.905.330
Fig. 33
Upper jaw
Superiore



DI.905.990
Fig. 99
Lateral
Laterale

Perforated without rim / Perforate senza bordo ritentivo

Lower left / Upper right
Inferiore sinistra / Superiore destra



No.	Size	Code / Codice
Fig. L2D	S	DI.899.040
Fig. L4D	M	DI.899.050
Fig. L6D	L	DI.899.060

Upper left / Lower right
Superiore sinistra / Inferiore destra



No.	Size	Code / Codice
Fig. L2S	S	DI.899.010
Fig. L4S	M	DI.899.020
Fig. L6S	L	DI.899.030

Perforated with rim / Perforate con bordo ritentivo

Lower left / Upper right
Inferiore sinistra / Superiore destra



No.	Size	Code / Codice
Fig. L2D	S	DI.901.040
Fig. L4D	M	DI.901.050
Fig. L6D	L	DI.901.060

Upper left / Lower right
Superiore sinistra / Inferiore destra



No.	Size	Code / Codice
Fig. L2S	S	DI.901.010
Fig. L4S	M	DI.901.020
Fig. L6S	L	DI.901.030



**Laboratory Instruments
Strumenti per Laboratorio**

Laboratory Instruments Strumenti per Laboratorio

Mean value articulators / Articolatore a valori medi

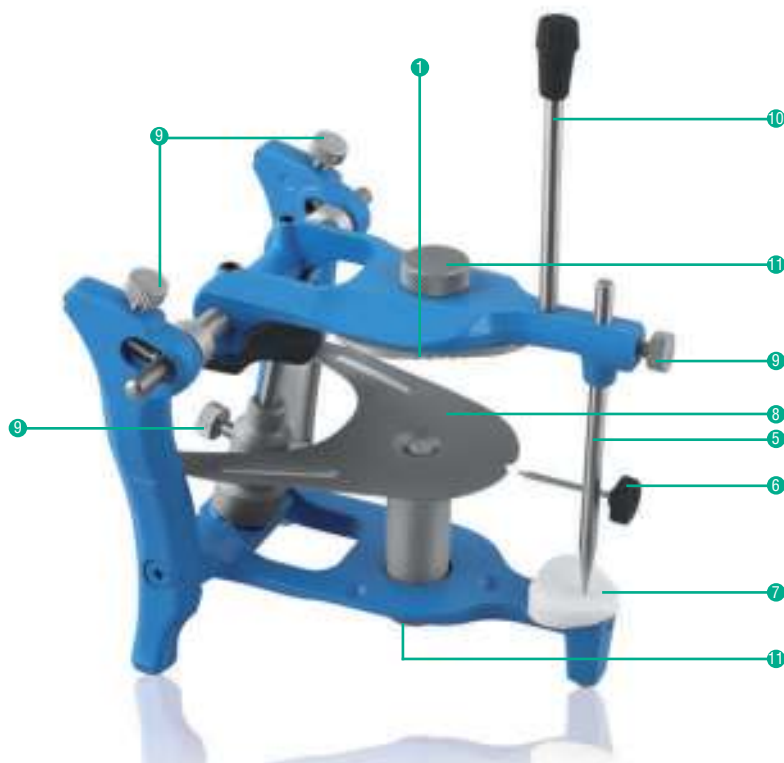

DL.050.000 Falcon

Contents:
1 x Articulator unit
1 x Occlusion plate
6 x Mounting plates (DL.050.001)
1 x Adjustable back rod
Contenuto:
1 x Articolatore
1 x Piano occlusale
6 x Piastrine portamodello (DL.050.001)
1 x Asta di registro posteriore

Accessories and spare parts for code DL.050.000 / Accessori e parti di ricambio per codice DL.050.000



1



2



3



4

- 1 DL.050.001 Mounting plates (pack of 10) / Piastrina portamodello (conf. 10 pz.)
- 2 DL.050.002 Complete magnetic plate / Piastrina magnetica completa
- 3 DL.050.003 Cast fastening washers (pack of 10) / Rondelle per fissaggio modelli (conf.10 pz.)
- 4 DL.050.004 Spare magnet / Medaglia magnetica di ricambio
- 5 DL.050.005 Incisal rod / Asta incisale
- 6 DL.050.006 Incisal indicator / Indicatore incisale

- 7 DL.050.007 Incisal table / Base incisale
- 8 DL.050.008 Occlusal plane/ Piano occlusale
- 9 DL.050.009 Lock screws / Viti per bloccaggio
- 10 DL.050.010 Bearing rod / Asta antiribaltamento
- 11 DL.050.011 Mounting screws / Viti maggiorate



DL.041.000 Falcon

Contents:
1 x Articulator unit
2 x Mounting plates (DL.050.001)
1 x Pack of mounting plates - 10 pcs (DL.050.001)
Contenuto:
1 x Articolatore
2 x Piastrine portamodello (DL.050.001)
1 x Conf. di piastrine portamodello da 10 pz. (DL.050.001)

Accessories and spare parts for DL.041.000 / Accessori e parti di ricambio per DL.041.000

- 1 DL.050.001 Mounting plates (pack of 10) / Piastrina portamodello (conf. 10 pz.)
- 2 DL.050.002 Complete magnetic plate / Piastrina magnetica completa
- 3 DL.050.003 Cast fastening washers (pack of 10) / Rondelle per fissaggio modelli (conf.10 pz.)
- 4 DL.050.004 Spare magnet / Medaglia magnetica di ricambio
- 11 DL.050.011 Mounting screws / Viti maggiorate

Plasterless articulator / Articolatore senza gesso



DL.060.000

Occlusor / Occlusore

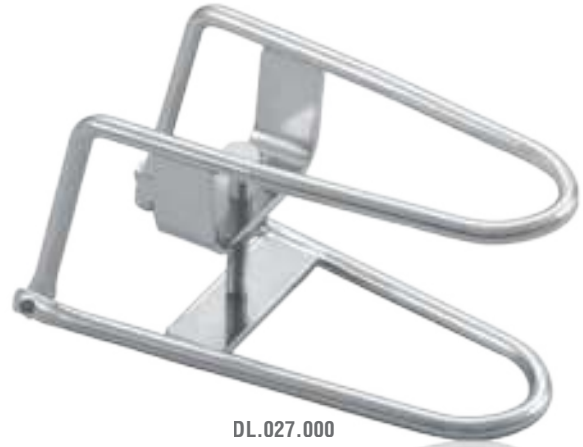

DL.027.000

Alcohol lamp deluxe / Lampada ad alcool deluxe



DL.015.010 Small / Piccola
DL.015.020 Large / Grande

Spare wicks (pack of 5)
Stoppino di ricambio (conf. 5 pz.)



DL.019.020

Micro torches / Micro bruciatori

- Instant electronic ignition
- Precise adjustable flame
- Temperature up to 2450°F/1343°C
- Accensione elettronica
- Fiamma regolabile
- Temperatura fino a 1343° C



DL.1000.00
Hand held or free standing
Con supporto

Alcohol lamp standard / Lampada ad alcool



DL.010.000

Spare wicks (pack of 5)
Stoppino di ricambio (conf. 5 pz.)



DL.019.010

Glass alcohol lamp / Lampada ad alcool in vetro



DL.009.000

Spare wicks (pack of 5)
Stoppino di ricambio (conf. 5 pz.)



DL.019.010



DL.1010.00

Laboratory Instruments Strumenti per Laboratorio

Calipers / Calibri

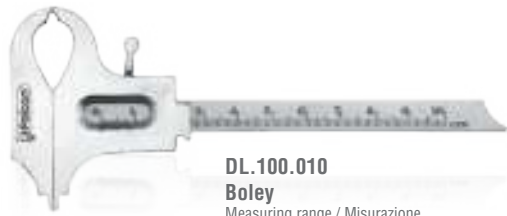

DL.100.010
Boley
Measuring range / Misurazione
0 - 100 mm



DL.100.020
Boley
Measuring range / Misurazione
0 - 100 mm



DL.101.030
Iwanson
for metal / per metallo
Measuring range / Misurazione
0-10 mm



DL.101.040
Iwanson
for wax / per cera
Measuring range / Misurazione
0-10 mm

Crown Grippers / Pinze per corone

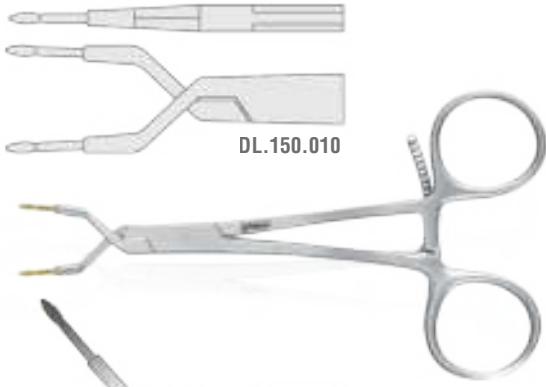

DL.150.010



DL.150.020



DL.151.125 125 mm
DL.151.150 150 mm



DL.154.020
125 mm

Crown scissors / Forbici per corone



BS.912.110
Bee Bee
110 mm



BS.915.095
Pedo
95 mm



BS.920.120

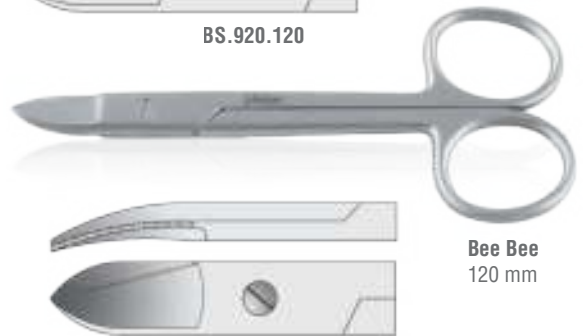

BS.921.120

Bee Bee
120 mm

Plaster cutters / Cesoia taglia gesso



DL.325.200
200 mm
Straight / Dritta

DL.326.200
200 mm
Curved / Curva

Fret saw and blades / Archetto e lame



DL.650.000

DL.650.010
Saw blades for metal / Lame per metallo
Pack of 12 pieces / Conf. 12 pezzi

DL.650.020
Saw blades for plaster / Lame per gesso
Pack of 12 pieces / Conf. 12 pezzi

Modeling saw and blades / Seghetto per modelli e lame



DL.655.000

DL.655.010
0.25 x 3 mm Pack of 12 pieces / Conf. 12 pezzi

DL.655.020
0.25 x 5 mm Pack of 12 pieces / Conf. 12 pezzi

DL.655.030
0.12 x 5 mm Pack of 12 pieces / Conf. 12 pezzi

Furnace Tongs and Tweezers / Pinze per cilindri e muffole



DL.790.200
200 mm

DL.790.300
300 mm



DL.700.310
310 mm



DL.705.400
400 mm



DL.715.560
560 mm

Soldering tweezers / Pinzette per saldatura



DL.780.010
160 mm



DL.780.020
160 mm

Riveting Mallets / Martelletti per rivettare



DL.255.010
Fig. 1
220 mm



DL.255.020
Fig. 2
220 mm

Laboratory Instruments Strumenti per Laboratorio

Spatulae rigid / Spatole rigide



DL.400.010 Falcon Fig. 1 185 mm



DL.400.020 Falcon Fig. 2 180 mm



DL.410.170 Lichtenstein 170 mm



DL.415.200 Roghe 200 mm



DL.450.080 Falcon Fig. 8 210 mm



DL.450.090 Falcon Fig. 9 230 mm

Spatulae flexible / Spatole flessibili



DL.450.030 Falcon Fig. 3 190 mm



DL.450.040 Falcon Fig. 4 200 mm



DL.450.050 Falcon Fig. 5 215 mm

Spatulae flexible / Spatole flessibili



DL.450.060 Falcon Fig. 6 210 mm



DL.450.070 Falcon Fig. 7 210 mm

Flexible plastic spatulae / Spatole flessibili in plastica



Flexible plastic
Flessibile in plastica
185 mm

	Colors	Codes
	Blue Dark / Blu	DL.461.010
	Green / Verde	DL.461.020
	Orange / Arancione	DL.461.030
	Pink / Rosa	DL.461.040
	Red / Rosso	DL.461.050
	White / Bianco	DL.461.060
	Yellow / Giallo	DL.461.070



DL.460.010 Falcon 190 mm
Super flexible plastic
Superflessibili in plastica

Bowls for plaster and alginate / Tazze per alginate e gesso



	Silicone Green / Verde	Polyethylene White / Bianco
Ø 100 mm	DL.500.011	DL.501.017
Ø 120 mm	DL.500.021	DL.501.027
Ø 140 mm	DL.500.031	DL.501.037
Ø 160 mm	DL.500.041	

Plaster knives with bakelite handle autoclavable / Coltelli per gesso con manico in bakelite autocavabile



DL.332.010 Falcon Fig. 1 180 mm

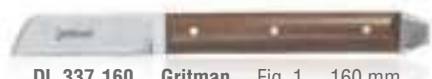

DL.337.160 Gritman Fig. 1 160 mm

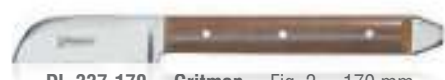

DL.337.170 Gritman Fig. 2 170 mm

Plaster knives with wooden handle / Coltelli per gesso con manico di legno



DL.330.010 Falcon Fig. 1 180 mm

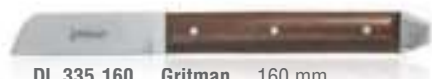

DL.335.160 Gritman 160 mm



DL.335.170 Gritman 170 mm

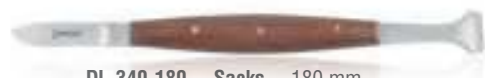

DL.340.180 Sacks 180 mm



DL.350.010 Falcon Fig. 1 170 mm

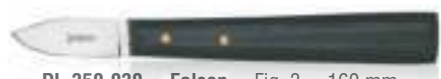

DL.350.030 Falcon Fig. 3 160 mm

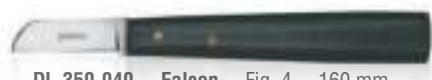

DL.350.040 Falcon Fig. 4 160 mm



DL.350.050 Falcon Fig. 5 135 mm

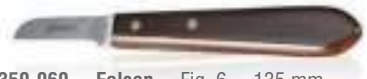

DL.350.060 Falcon Fig. 6 135 mm

Wax knives with bakelite handle, autoclavable / Coltelli per cera con manico in bakelite, autoclavabile



DL.815.070 Fahnenstock 130 mm



DL.815.080 Fahnenstock 175 mm



DL.825.070 Lessmann 130 mm

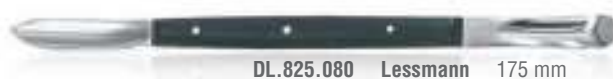

DL.825.080 Lessmann 175 mm

Wax knives with metal handle, autoclavable / Coltelli per cera con manico in metallo, autoclavabili



DL.815.030 Fahnenstock 130 mm



DL.815.040 Fahnenstock 175 mm



DL.825.030 Lessmann 130 mm

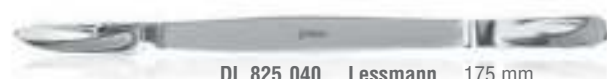

DL.825.040 Lessmann 175 mm

Wax knives Ermert / Coltelli per cera Ermert

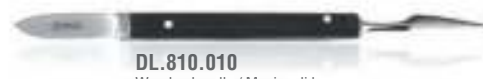

DL.810.010
Wooden handle / Manico di legno



DL.810.030
Plastic handle / Manico in plastica



DL.810.020
Metal handle / Manico in metallo

Laboratory Instruments Strumenti per Laboratorio

Wax knives with plastic handle, non-autoclavable / Coltelli per cera con manico in plastica, non-autoclavabili



	Colours	Fahnenstock 130 mm	Fahnenstock 175 mm
	Black / Nero	DL. 815.050	DL. 815.060
	Blue / Blu	DL. 815.051	DL. 815.061
	Green / Verde	DL. 815.052	DL. 815.062
	Red / Rosso	DL. 815.053	DL. 815.063
	White / Bianco	DL. 815.054	DL. 815.064
	Yellow / Giallo	DL. 815.055	DL. 815.065



	Colours	Lessmann 130 mm	Lessmann 175 mm
	Black / Nero	DL. 825.050	DL. 825.060
	Blue / Blu	DL. 825.051	DL. 825.061
	Green / Verde	DL. 825.052	DL. 825.062
	Red / Rosso	DL. 825.053	DL. 825.063
	White / Bianco	DL. 825.054	DL. 825.064
	Yellow / Giallo	DL. 825.055	DL. 825.065

Wax knives with wooden handle / Coltelli per cera con manico di legno



DL.805.010 con scodellino 130 mm



DL.805.020 con scodellino 175 mm



DL.815.010 Fahnenstock 130 mm



DL.815.020 Fahnenstock 175 mm



DL.825.010 Lessmann 130 mm



DL.825.020 Lessmann 175 mm

Ceramic sculpturing instruments / Strumenti per ceramica



DL.950.010 Fig. 1



DL.950.020 Fig. 2



DL.950.030 Fig. 3
Knife / Coltello



DL.950.000
Set of 3 / Serie da 3



DL.955.010 Fig. 1



DL.955.020 Fig. 2



DL.955.030 Fig. 3



DL.955.000
Set of 3 / Serie da 3

Flexible / Flessibili



DL.949.010 Fig. 1



DL.949.030 Fig. 3
Knife / Coltello



DL.949.020 Fig. 2

Super flexible / Superflessibili



DL.949.011 Fig. 1



DL.949.031 Fig. 3
Knife / Coltello



DL.949.021 Fig. 2

Modeling carvers / Strumenti per modellare

P.K. Thomas



DL.905.010 Fig. 1



DL.905.020 Fig. 2



DL.905.050 Fig. 5



DL.905.030 Fig. 3



DL.905.000
Set of 5 / Serie da 5



DL.905.040 Fig. 4

P.K. Thomas



DL.900.010 Fig. 1



DL.900.020 Fig. 2



DL.900.050 Fig. 5



DL.900.030 Fig. 3



DL.900.000
Set of 5 / Serie da 5



DL.900.040 Fig. 4



DL.932.010 Vehe Fig. 1



DL.864.130 Falcon Fig. 13



DL.870.310 Gritman Fig. 31



DL.855.010 Beale Fig. 1



DL.864.120 Falcon Fig. 12



DL.918.010 Roach Fig. 1



Laboratory Instruments Strumenti per Laboratorio

Wax Modeling Carvers / Strumenti per modellare



DL.864.010
Falcon
Fig. 1
130 mm



DL.864.020
Falcon
Fig. 2
140 mm



DL.864.030
Falcon
Fig. 3
140 mm



DL.864.040
Falcon
Fig. 4
135 mm



DL.864.050
Falcon
Fig. 5
140 mm



DL.864.060
Falcon
Fig. 6
117 mm



DL.864.070
Falcon
Fig. 7
115 mm



DL.945.010
Zahle
Fig. 1
120 mm



DL.945.020
Zahle
Fig. 2
125 mm



DL.945.030
Zahle
Fig. 3
125 mm



DL.945.040
Zahle
Fig. 4
120 mm















DL.945.050
Zahle
Fig. 5
120 mm



DL.945.060
Zahle
Fig. 6
115 mm

Wax Modeling Carvers / Strumenti per modellare

	DL.875.010 Hylin Fig. 1 135 mm
	DL.875.030 Hylin-Ceramica Fig. 3 135 mm
	DL.875.050 Hylin-Falcon Fig. 5 135 mm
	DL.875.060 Hylin-Lecron Fig. 6 135 mm
	DL.882.010 Lecron-Mini Fig. 1 100 mm
	DL.882.020 Lecron-Mini Fig. 2 130 mm
	DL.882.030 Lecron-Mini Fig. 3 130 mm
	DL.880.010 Lecron Fig. 1 165 mm
	DL.880.020 Lecron Fig. 2 165 mm
	DL.880.030 Lecron Fig. 3 165 mm
	DL.880.040 Lecron Fig. 4 165 mm
	DL.880.070 Lecron Fig. 7 160 mm
	DL.880.080 Lecron Fig. 8 160 mm



Laboratory Instruments Strumenti per Laboratorio

Tungsten Carbide Burs / Fresoni al carburo di tungsteno

- Made of high quality Tungsten Carbide
 - Precision toothing, superior cutting and durable
 - Perfectly concentric
 - Available in x-fine, fine, medium, coarse and x-coarse grits
 - Color coded according to grit type
 - Standard ISO patterns
- Realizzate in carburo di tungsteno di elevata qualità
 - Dentatura di precisione, qualità del taglio e durata superiori
 - Perfetta concentricità
 - Disponibili con grana extra fine, fine, grossa ed extra grossa
 - Grana codificata a colori
 - Conformi agli standard ISO

Cross Cut Fine (ISO-No. 140)

For delicate and difficult trimming of hard alloys, acrylics and ceramics.
Per rifinire con precisione e delicatezza leghe dure, acrilici e ceramiche.



Shank	ISO No.	DB.9257.233	DB.9237.233	DB.9225.233	DB.9141.233	DB.9289.233	DB.9198.233	DB.9187.233	DB.9292.233	DB.9113.603
HP	500 104...	257..140	... 237..140	... 225..140	... 141..140	... 289..140	... 198..140	... 187..140	... 292..140	... 113..140
	Ø mm	2,3	2,3	2,3	2,3	2,3	2,3	2,3	2,3	6,0
	L1 mm	5,5	5,5	5,5	8,0	8,0	8,0	15,0	14,0	12,5
	L2 mm	45,0	45,0	45,0	45,0	45,0	45,0	45,0	45,0	52,0



Shank	ISO No.	DB.9145.233	DB.9123.233	DB.9200.403	DB.9201.503	DB.9200.603	DB.9237.603	DB.9275.603	DB.9144.603
HP	500 104...	... 145..140	... 123..140	... 194..140	... 201..140	... 200..140	... 237..140	... 275..140	... 144..140
	Ø mm	2,3	2,3	4,0	5,0	6,0	6,0	6,0	6,0
	L1 mm	14,0	14,0	13,5	13,5	13,5	13,0	14,0	13,0
	L2 mm	45,0	45,0	52,0	52,0	52,0	52,0	52,0	52,0

Tungsten Carbide Burs / Fresoni al carburo di tungsteno

Cross Cut X-Fine (ISO-No. 110)

For fine, precise trimming of ceramics, precious metals and all non-precious alloys.
Per rifinire con precisione ceramiche, metalli preziosi e leghe non preziose.



Shank	ISO No.	DB.9237.232	DB.9199.232	DB.9292.232	DB.9145.232	DB.9200.402
HP	500 104...	... 237..110	... 199..110	... 292..110	... 145 110	... 200..110
	Ø mm	2,3	2,3	2,3	2,3	4,0
	L1 mm	5,5	11,5	14,0	14,0	13,5
	L2 mm	45,0	45,0	45,0	45,0	52,0

Cross Cut Standard (ISO-No.190)

For trimming large surfaces of acrylics, tray materials and plaster.
Per rifinire ampie superfici di acrilici, materiali da impronta e gesso.



Shank	ISO No.	DB.9142.234	DB.9185.234	DB.9187.454	DB.9199.234	DB.9200.604	DB.9250.234	DB.9275.604
HP	500 104...	... 142..190	... 185..190	... 187..190	... 199..190	... 200..190	... 250..190	... 275..190
	Ø mm	2,3	2,3	4,5	2,3	6,0	2,3	6,0
	L1 mm	2,3	2,3	11,5	11,0	13,5	9,5	14,0
	L2 mm	45,0	45,0	48,0	45,0	52,0	45,0	52,0

Cross Cut Coarse (ISO-No. 220)

For trimming large surfaces of acrylics, tray materials and plaster.
Per rifinire ampie superfici di acrilici, materiali da impronta e gesso.



Shank	ISO No.	DB.9001.235	DB.9001.405	DB.9199.235	DB.9187.235	DB.9292.235	DB.9145.235	DB.9122.235
HP	500 104...	... 001 220	... 001 220	... 199..220	... 187..220	... 292..220	... 145 220	... 122 220
	Ø mm	2,3	4,5	2,3	2,3	2,3	2,3	2,3
	L1 mm	2,3	3,4	11,0	15,5	2,3	14,0	14,0
	L2 mm	45,0	45,0	45,0	45,0	45,0	45,0	45,0



Laboratory Instruments Strumenti per Laboratorio

Tungsten Carbide Burs / Fresoni al carburo di tungsteno

Cross Cut Coarse (ISO-No. 220)

For trimming large surfaces of acrylics, tray materials and plaster.
Per rifinire ampie superfici di acrilici, materiali da impronta e gesso.



Shank	ISO No.	DB.9200.405	DB.9201.505	DB.9201.605	DB.9200.605	DB.9237.605	DB.9277.605	DB.9275.605	DB.9144.605	DB.9113.605
HP	500 104...	... 200..220	... 201..220	... 201..220	... 200..220	... 237..220	... 277..220	... 275..220	... 144..220	... 113..220
	Ø mm	4,0	5,0	6,0	6,0	6,0	6,0	6,0	6,0	6,0
	L1 mm	13,5	13,5	13,5	13,0	13,0	14,0	13,5	13,5	13,2
	L2 mm	52,0	52,0	52,0	52,0	52,0	52,0	52,0	52,0	51,0

Cross Cut X-Coarse (ISO-No. 223)

The optimum for plaster – also wet plaster.
Ottimali per gesso - anche per gesso umido.



Shank	ISO No.	DB.9200.408	DB.9201.608	DB.9275.608	DB.9144.608
HP	500 104...	... 200..223	... 201..223	... 275..223	... 144..223
	Ø mm	4,0	6,0	6,0	6,0
	L1 mm	13,5	13,5	13,5	13,5
	L2 mm	52,0	52,0	52,0	50,0



Orthodontic
Ortodonzia

Orthodontic Ortodonzia

Measuring instruments / Strumenti di misurazione



DO.170.000 Beerendonk

Dental vernier with long and fine tips for intraoral measurements
Nonio dentale con punte lunghe e sottili per misurazioni intraorali



DO.172.000 Falcon

Double sided, for inner and outer measurements
Bilaterale, per misurazioni interne ed esterne



DO.160.000 Bernklau

Orthodontic ruler, Perfect for all diagnostic measurements, both intraoral and on the model
Regolo ortodontico, Ideale per tutte le misurazioni diagnostiche intra-orali o sul modello



BA.225.150 150 mm / 6" Ruler stainless steel
BA.225.300 300 mm / 12" Righello in acciaio inox



DO.151.000 Falcon

Bow divider, to measure tooth width, bracket distance to the incisal edge etc.
Compasso ortodontico per la misurazione dei denti, la distanza degli attacchi dall'asse incisale, ecc.



DO.175.000
Orthodontic bow compass / Compasso ortodontico

Bracket positioning gauge / Calibri per il posizionamento degli attacchi



Bracket positioning gauge
Facilitate bracket positioning to exact desired distance by measuring its height, from slot to incisal / occlusal surface of tooth

Calibro per il posizionamento degli attacchi
Facilita l'ideale posizionamento dell' attacco mediante misurazione dallo slot alla superficie incisale / occlusale del dente



DO.200.010 Boone

Universal for both .018" or .022" slot brackets
Four different heights for bracket positioning:
3.5, 4, 4.5, & 5 mm
Stainless Steel, autoclavable

Universale per attacchi con slot di .018" o .022".
Consente il posizionamento dell' attacco a quattro diverse altezze: 3.5 mm, 4 mm, 4.5 mm e 5 mm
In acciaio inox, autoclavabile

Falcon bracket positioning gauges
Four different heights for bracket positioning: 3.5, 4, 4.5, & 5 mm
Two different models for .018" or .022" slot brackets



Calibri per il posizionamento degli attacchi Falcon
adatto per slot di .018" o .022" consente il posizionamento dell' attacco a quattro diverse altezze: 3.5 mm, 4 mm, 4.5 mm e 5 mm



DO.205.018 For .018" slot brackets / Per attacchi con slot .018"
DO.205.022 For .022" slot brackets / Per attacchi con slot .022"
Anodized aluminum, autoclavable
In alluminio anodizzato, autoclavabile



DO.206.018 For .018" slot brackets / Per attacchi con slot .018"
DO.206.022 For .022" slot brackets / Per attacchi con slot .022"
Stainless steel
In acciaio inox



DO.204.000
Stainless steel
In acciaio inox

Instruments for D.B. brackets / Strumenti per attacchi D.B.

Bracket placing tweezers / Pinzette per posizionare attacchi



SDV69
150 mm



DO.210.135
135 mm



DO.217.135
135 mm



DO.220.110
110 mm

Bracket tweezers with slot aligner / Pinzette per posizionare attacchi con allineatore



DO.213.135
Fig. 1
135 mm



DO.214.135
Fig. 2
135 mm



DO.215.135
Fig. 3
135 mm



Bracket pler for posterior teeth
Very helpful instrument for placing D.B.brackets from bicuspids to molars, the small head offers excellent view

Strumento per posizionare gli attacchi per denti posteriori
Utilissimo per posizionare gli attacchi D. B. dai bicuspidi ai molari. La testa di piccole dimensioni consente un eccellente campo visivo



DO.209.010

Instruments for bands and buccal tubes / Strumenti per bande e per tubetti buccali



Band pusher with serrated rectangular tip for good transfer of force when positioning bands.
Spingibande con punta rettangolare zigrinata per una pressione ideale durante il posizionamento delle bande.



DO.120.010
Mershon



Band seating instrument with hard metal triangular serrated tip, autoclavable 121° C
Posizionatore di bande con punta triangolare zigrinata, autoclavabile 121° C



DO.125.010
Falcon



DO.227.120 120 mm Buccal tube tweezers
DO.227.135 135 mm Pinzetta per tubetti buccali
Keat



DO.228.125 125 mm Reverse action buccal tube tweezers
DO.228.135 135 mm Pinzetta per tubetti buccali ad azione invertita
Falcon

Orthodontic Ortodonzia

Scaler and band pushing Instruments

Sharp scaling tip on one end and serrated band pusher on the other

Scaler / Spingibande

Scaler da un lato e spingibande zigrinato dall'altro

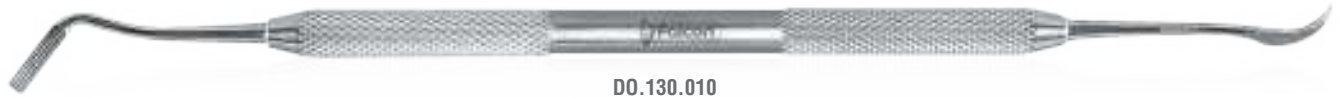

DO.130.010



DO.130.015

Adhesive remover

For removing residue of adhesive from tooth after removal of D.B. Bracket.

Strumento per rimuovere residui di adesivo

Per rimuovere i residui di adesivo dai denti dopo la rimozione degli attacchi D.B.



DO.235.010



DO.235.015



Distal end bending instruments

Very useful instrument for bending archwire distal ends to the buccal tube to create an easy cinch back bend in an area which is usually very hard to reach.

Simply insert instrument to distal end of wire extracting through buccal tube and twist forward. Also can be used to bend tails of springs

Strumenti per piegature distali.

Di grande utilità per piegare distalmente tutti i fili in acciaio e NiTi in zone solitamente poco accessibili.

Semplicemente inserire lo strumento e torcere in avanti. Può anche essere usato per piegare le estremità delle molle.



DO.240.010

For wire upto .022" (0.56 mm)
Per fili fino a .022" (0.56 mm)

DO.240.020

For wire upto .030" (0.76 mm)
Per fili fino a .030" (0.76 mm)



DO.240.015

For wire upto .022" (0.56 mm)
Per fili fino a .022" (0.56 mm)

DO.240.025

For wire upto .030" (0.76 mm)
Per fili fino a .030" (0.76 mm)



DO.240.035

For wires .022" (0.56 mm) and .030" (0.76 mm)
Per fili .022" (0.56 mm) e .030" (0.76 mm)

Elastic ligature applicators

For easy placement of elastic ligatures under bracket tie wings.

Applicatore per legature elastiche

Facilita l'applicazione delle legature elastiche sugli attacchi.



DO.250.010



DO.377.015
Elastic ligature applicator



Elastomeric ligature removing instruments / Strumenti per rimuovere le legature



DD.155.160
Fig. 23/16
Explorer

Ligature tuckers

Used to tuck metal ligatures, also useful for inserting arch wires into bracket slots and applying elastic chains. Straight end is for anterior use and angled of posterior.

Direzionatori di legature

Per ripiegare legature metalliche e anche per inserire gli archi negli slot e applicare catene elastiche. Lato dritto per uso anteriore, lato piegato per uso posteriore



DO.375.010



DO.376.010



DO.377.010



DO.370.015



DO.370.025



DO.377.015



Separators placing pliers / Pinze per separatori

For easy placement of radiopaque and non-radiopaque separators.

Facilita il posizionamento dei separatori radio e non-radiopachi.



DO.270.160
160 mm



DO.271.165
165 mm



DO.272.165
165 mm



DO.270.155
155 mm

Elastomeric ligature removing tweezers / Pinzette per rimuovere le legature

For easy removal of elastomeric ligatures / Facilitano la rimozione delle legature



DO.285.010

Elastics ligature placing forceps with groove / Pinze con scanalatura per applicare legature elastiche

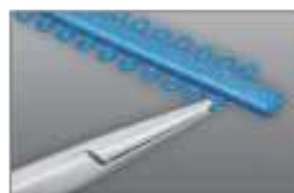

Excellent for placing elastic ligatures, grooved tip provides non-slip grip of any type of elastomeric.

Ideale grazie alle punte scanalate che trattengono positivamente qualsiasi legatura elastica.



DO.292.120
Falcon
120 mm



DO.295.140
Falcon
140 mm

Elastic ligature placing forceps / Pinze per posizionare le legature elastiche



Elastic ligature placing forceps with hook
Excellent for placing elastic ligatures, hook on
tip provides non-slip grip of any type of elastomeric.

Pinze con gancio per posizionare le legature
elastiche

Ideale per trattare in maniera positiva qualsiasi tipo
di legatura elastica grazie al gancio di cui è munita una
punta



DO.290.120
Falcon
120 mm
Straight / Dritta



DO.291.120
Falcon
120 mm
Curved / Curva



DO.294.140
Falcon
140 mm

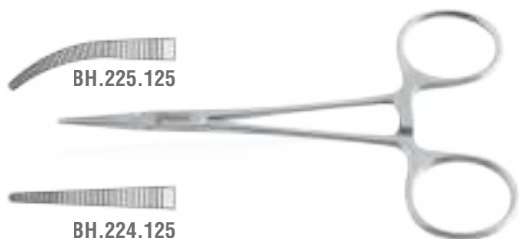

BH.225.125

BH.224.125

Halsted-Mosquito
125 mm

Ligature Pliers / Pinze per legatura

Falcon offers wide variety of pliers for ligatures wires with or without tungsten carbide
inserts.

Falcon and Smaha pattern pliers have finer tips than standard Mathieu patterns, these
are also suitable for placing elastic ligatures.

La Falcon offre una vasta varietà di pinze per legature con e senza riporti in carburo di
tungsteno.

I modelli Falcon e Smaha hanno le punte più fini dei Mathieu e sono quindi anche adatte
a posizionare le legature elastiche.



With tungsten carbide inserts
Con inserti al carburo di tungsteno



DO.393.030
Falcon
140 mm



DO.392.010

Falcon
140 mm



DO.392.020



DO.392.030



DO.396.140

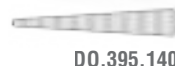

DO.395.140

Smaha
140 mm



Orthodontic Ortodonzia

Pliers for "Fixed Appliance Technique" / Pinze per ortodonzia fissa

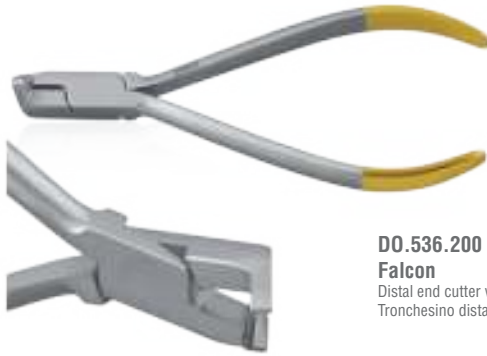

DO.536.200
Falcon
Distal end cutter with safety hold
Tronchesino distale con trattenuta del filo

- Max. 0.30 mm to 0.50 mm (.012" to .020")
- Max. 0.46 mm x 0.64 mm (.018" x .025")
- ⊗ Max. 0.38 mm to 0.53 mm (.0155" to .0215")
- ⊗ Max. 0.53 mm x 0.64 mm (.021" x .025")

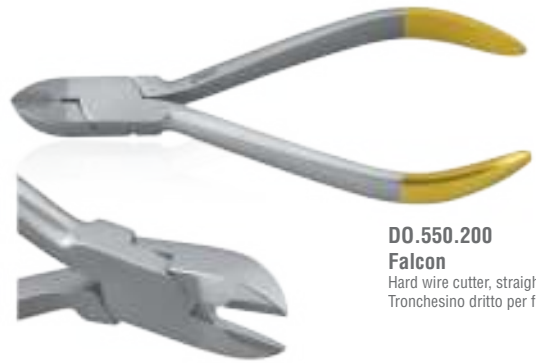

DO.550.200
Falcon
Hard wire cutter, straight
Tronchesino dritto per fili duri

- Max. 0.30 mm to 0.50 mm (.012" to .020")
- Max. 0.56 mm x 0.71 mm (.022" x .028")

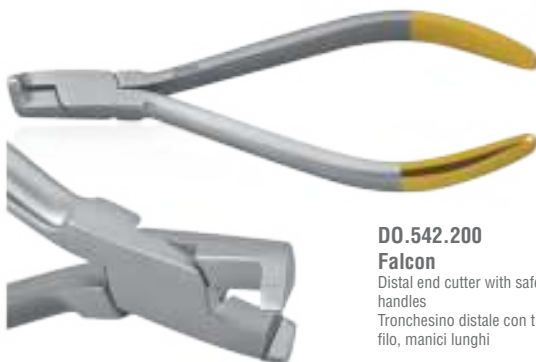

DO.542.200
Falcon
Distal end cutter with safety hold, long handles
Tronchesino distale con trattenuta del filo, manici lunghi

- Max. 0.30 mm to 0.50 mm (.012" to .020")
- Max. 0.46 mm x 0.64 mm (.018" x .025")
- ⊗ Max. 0.38 mm to 0.53 mm (.0155" to .0215")
- ⊗ Max. 0.53 mm x 0.64 mm (.021" x .025")



DO.555.200
Falcon
Hard wire cutter, angled
Tronchesino dritto per fili duri

- Max. 0.30 mm to 0.50 mm (.012" to .020")
- Max. 0.56 mm x 0.71 mm (.022" x .028")



DO.545.200
Falcon
Flush-Cut distal end cutter with safety hold, long handles
Tronchesino distale con trattenuta del filo, manici lunghi

- Max. 0.30 mm to 0.50 mm (.012" to .020")
- Max. 0.46 mm x 0.64 mm (.018" x .025")
- ⊗ Max. 0.38 mm to 0.53 mm (.0155" to .0215")
- ⊗ Max. 0.53 mm x 0.64 mm (.021" x .025")

Pliers for "Fixed Appliance Technique" / Pinze per ortodonzia fissa



Falcon
CUT

DO.565.200
Falcon-Micro
Soft wire and ligature cutter,
Micro
Micro tronchesino per
legature e fili teneri

25 mm to .38 mm (.010" to .015")



DO.571.200
Falcon-Mini
Soft wire and ligature cutter,
Mini
Mini tronchesino per legature
e fili teneri

25 mm to .38 mm (.010" to .015")



DO.574.200
Falcon-Standard
Soft wire and ligature cutter,
Standard
Standard tronchesino per
legature e fili teneri

25 mm to .38 mm (.010" to .015")



DO.580.300
Falcon
Ligature forming pliers
Pinza per formare legature

25 mm to .38 mm (.010" to .015")



DO.492.300
Falcon
Band removing pliers
Pinza per la rimozione di bande

DO.495.010
Replacement pads 4.8 mm (1/4"), 2 pieces
Cuscinetti di ricambio 4,8 mm (1/4"), 2 pezzi

DO.495.020
Replacement pads 6.3 mm (3/16"), 2 pieces
Cuscinetti di ricambio 6,3 mm (3/16"), 2 pezzi



DO.465.300
Johnson
Contouring pliers
Pinza per rifinire



DO.475.300
Reynolds
Contouring pliers
Pinza per rifinire

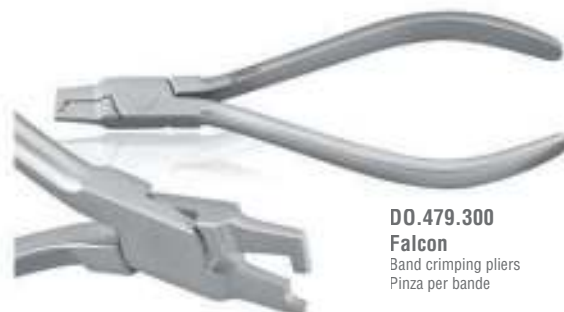

DO.479.300
Falcon
Band crimping pliers
Pinza per bande

Pliers for "Fixed Appliance Technique" / Pinze per ortodonzia fissa

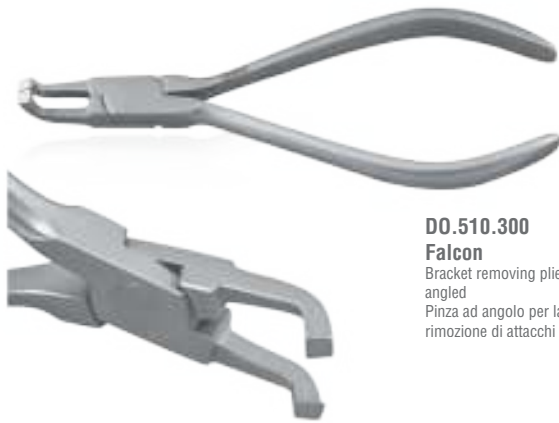

DO.510.300
Falcon
Bracket removing pliers
angled
Pinza ad angolo per la
rimozione di attacchi



DO.525.300
Falcon
Adhesive removing pliers
Pinza per rimuovere residui
di adesivo



DO.525.010
Replacement metal tip
Punta metallica di ricambio

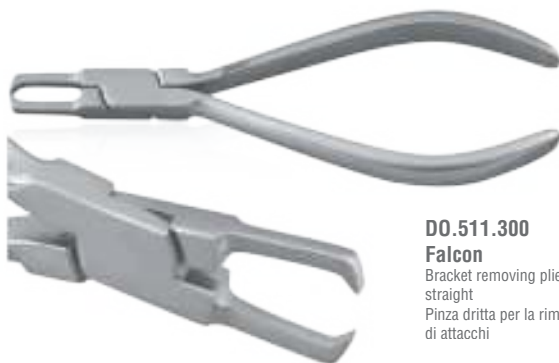

DO.511.300
Falcon
Bracket removing pliers
straight
Pinza dritta per la rimozione
di attacchi

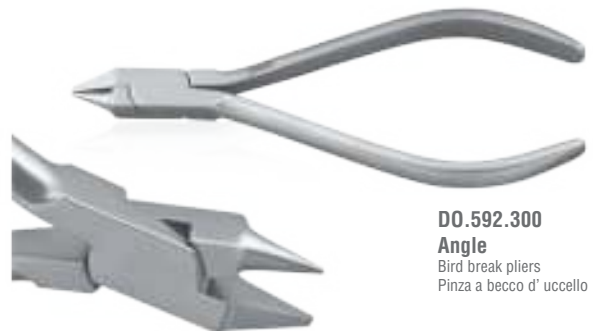

DO.592.300
Angle
Bird break pliers
Pinza a becco d' uccello

● 0.36 mm to 0.71 mm (.014" to .028")
■ Max. 0.56 mm x 0.71 mm (.022" x .028")



DO.520.300
Falcon
Bracket removing pliers with
plastic tip
Pinza con guarnizione in
plastica per

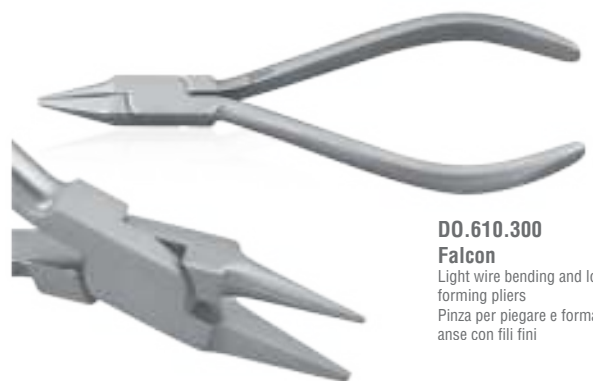

DO.610.300
Falcon
Light wire bending and loop
forming pliers
Pinza per piegare e formare
anse con fili fini

● 0.36 mm to 0.50 mm (.012" to .020")
■ Max. 0.41 mm x 0.56 mm (.016" x .022")

Pliers for "Fixed Appliance Technique" / Pinze per ortodonzia fissa



With tungsten carbide inserts
Con inserti al carburo di tungsteno

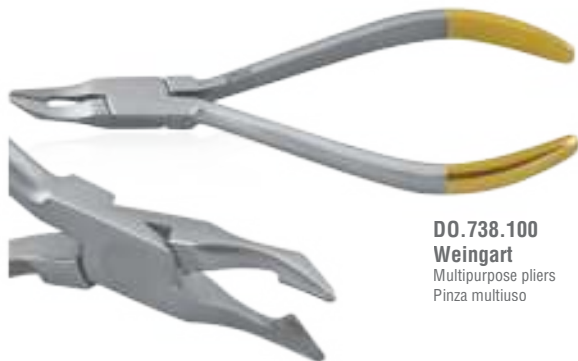

DO.738.100
Weingart
Multipurpose pliers
Pinza multiuso

- Max. 0.30 mm to 0.50 mm (.012" to .020")
- Max. 0.56 mm x 0.71 mm (.022" x .028")

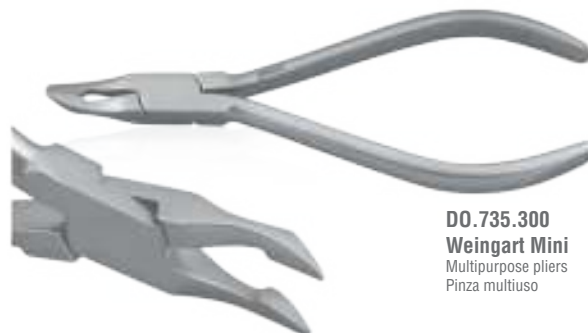

DO.735.300
Weingart Mini
Multipurpose pliers
Pinza multiuso

- Max. 0.30 mm to 0.50 mm (.012" to .020")
- Max. 0.56 mm x 0.71 mm (.022" x .028")



DO.735.100
Weingart Mini
Multipurpose pliers
Pinza multiuso

- Max. 0.30 mm to 0.50 mm (.012" to .020")
- Max. 0.56 mm x 0.71 mm (.022" x .028")

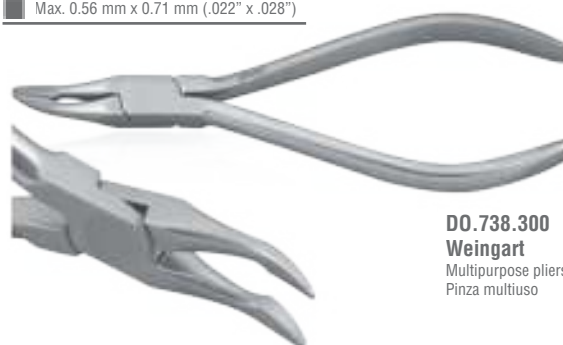

DO.738.300
Weingart
Multipurpose pliers
Pinza multiuso

- Max. 0.30 mm to 0.50 mm (.012" to .020")
- Max. 0.56 mm x 0.71 mm (.022" x .028")

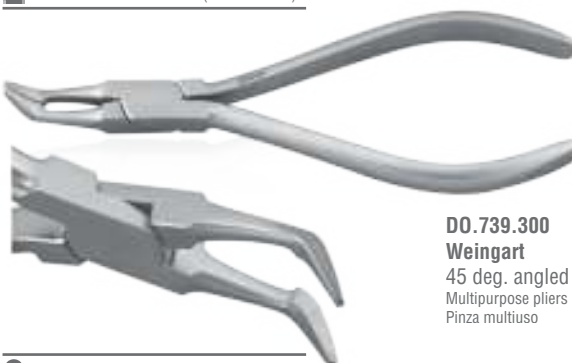

DO.739.300
Weingart
45 deg. angled
Multipurpose pliers
Pinza multiuso

- Max. 0.30 mm to 0.50 mm (.012" to .020")
- Max. 0.56 mm x 0.71 mm (.022" x .028")



DO.736.300
Weingart Narrow
Multipurpose pliers
Pinza multiuso

- Max. 0.30 mm to 0.50 mm (.012" to .020")
- Max. 0.56 mm x 0.71 mm (.022" x .028")



DO.624.300
Falcon
(Hammer head)
Distal end bending pliers
Tronchesino per ripiegature
distali

- Max. 0.30 mm to 0.50 mm (.012" to .020")
- Max. 0.56 mm x 0.71 mm (.022" x .028")



Orthodontic Ortodonzia

Pliers for "Fixed Appliance Technique" / Pinze per ortodonzia fissa

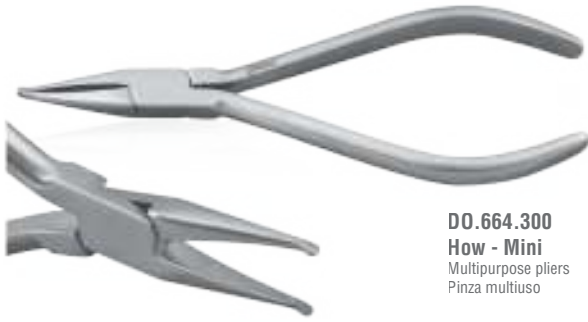

DO.664.300
How - Mini
Multipurpose pliers
Pinza multiuso

● 0.30 mm to 0.50 mm (.012" to .020")
■ Max. 0.56 mm x 0.71 mm (.022" x .028")



DO.665.300
How - Mini
Multipurpose pliers
Pinza multiuso

● 0.30 mm to 0.50 mm (.012" to .020")
■ Max. 0.56 mm x 0.71 mm (.022" x .028")



DO.661.300
How
Multipurpose pliers
Pinza multiuso

● 0.30 mm to 0.50 mm (.012" to .020")
■ Max. 0.56 mm x 0.71 mm (.022" x .028")



DO.662.300
How
Multipurpose pliers
Pinza multiuso

● 0.30 mm to 0.50 mm (.012" to .020")
■ Max. 0.56 mm x 0.71 mm (.022" x .028")

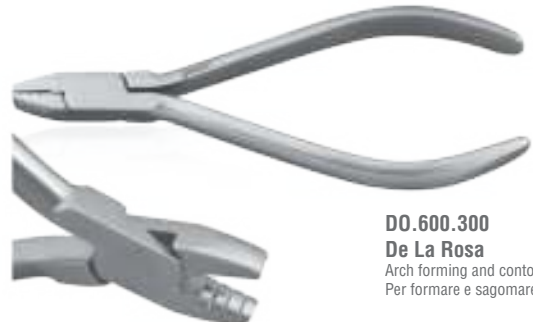

DO.600.300
De La Rosa
Arch forming and contouring plier
Per formare e sagomare archi

● 0.36 mm to 0.50 mm (.012" to .020")
■ Max. 0.53 mm x 0.64 mm (.021" x .025")



DO.602.300
De La Rosa
Arch forming and contouring plier
Per formare e sagomare archi

● 0.36 mm to 0.50 mm (.012" to .020")
■ Max. 0.53 mm x 0.64 mm (.021" x .025")



DO.613.300
Hollow-Chop
Archwire forming pliers, concave and convex tips
Pinza concava convessa per formare archi

● 0.30 mm to 0.71 mm (.012" to .020")
■ Max. 0.56 mm x 0.71 mm (.022" x .028")

Pliers for "Fixed Appliance Technique" / Pinze per ortodonzia fissa

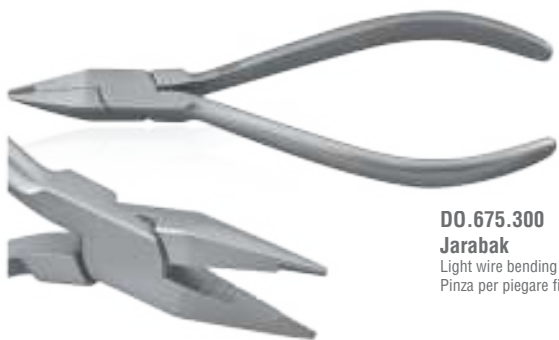

DO.675.300
Jarabak
Light wire bending pliers
Pinza per piegare fili fini.

● 0.30 mm to 0.50 mm (.012" to .020")
■ Max. 0.46 mm x 0.56 mm (.018" x .022")



DO.705.300
Tweed
Loop forming pliers
Pinza per formare le anse

● 0.30 mm to 0.50 mm (.012" to .020")
■ Max. 0.46 mm x 0.56 mm (.018" x .022")

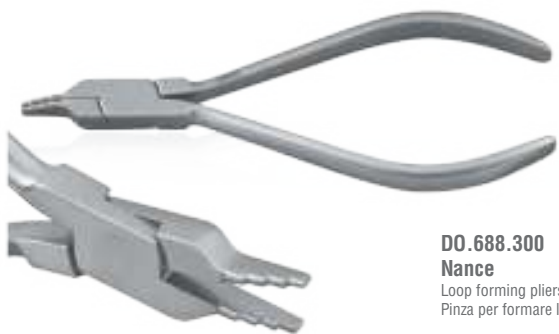

DO.688.300
Nance
Loop forming pliers
Pinza per formare le anse

● 0.36 mm to 0.71 mm (.014" to .028")
■ Max. 0.56 mm x 0.71 mm (.022" x .028")



DO.712.300
Tweed
Loop forming pliers
Pinza per formare le anse

● Max. 0.36 mm to 0.64 mm (.014" to .025")
■ Max. 0.53 mm x 0.64 mm (.021" x .025")

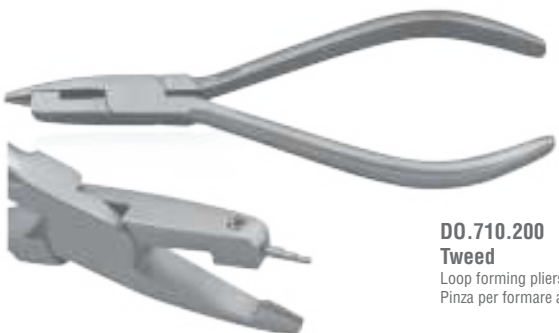

DO.710.200
Tweed
Loop forming pliers
Pinza per formare anse

● Max. 0.36 mm to 0.64 mm (.014" to .025")
■ Max. 0.53 mm x 0.64 mm (.021" x .025")



DO.700.010
Replacement tip
Punta di ricambio



DO.713.300
Tweed/Angle
Rectangular arch forming and
torquing pliers
Pinze per torquing e per
formare archi rettangolari

● Max. 0.30 mm to 0.71 mm (.012" to .028")
■ Max. 0.56 mm x 0.71 mm (.022" x .028")



Pliers for "Fixed Appliance Technique" / Pinze per ortodonzia fissa

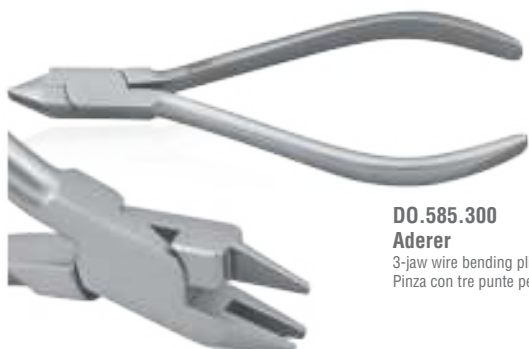

DO.585.300
Aderer
3-jaw wire bending pliers
Pinza con tre punte per piegare.

● 0.36 mm to 0.76 mm (.014" to .030")
■ Max. 0.56 mm x 0.71 mm (.022" x .028")



DO.630.300
Falcon
Detailing step pliers / Bayonet bending pliers - 1mm
Pinze per piegatura a Baionetta -1mm

● 0.30 mm to 0.50 mm (.012" to .020")
■ Max. 0.56 mm x 0.71 mm (.022" x .028")

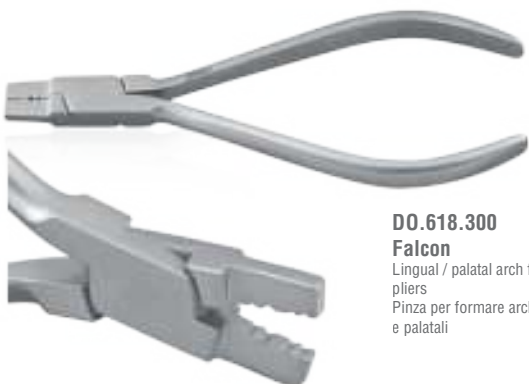

DO.618.300
Falcon
Lingual / palatal arch forming pliers
Pinza per formare archi linguale e palatali

● 0.76 mm (.030") / 0.91 mm (.036")

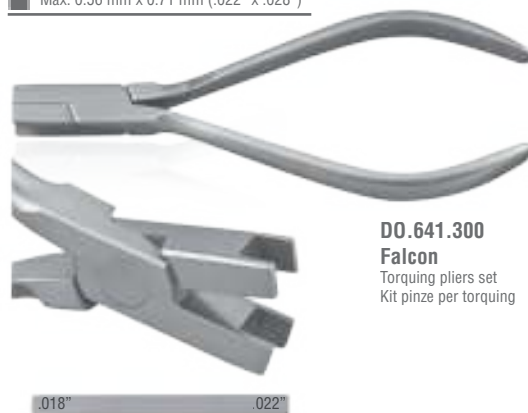

DO.641.300
Falcon
Torquing pliers set
Kit pinze per torquing

.018" .022"



DO.655.300
Falcon
Stop pliers V-Bend - 1mm
Pinze per piegatura a V dei fili -1mm

● 0.30 mm to 0.50 mm (.012" to .020")
■ Max. 0.43 mm x 0.56 mm (.017" x .022")



DO.621.300
Falcon
Ball hook crimping pliers
Pinza per grippare ganci e stop



DO.620.300
Falcon
Ball hook crimping pliers
Pinza per grippare ganci e stop

Pliers for aligners / Pinze per allineatori

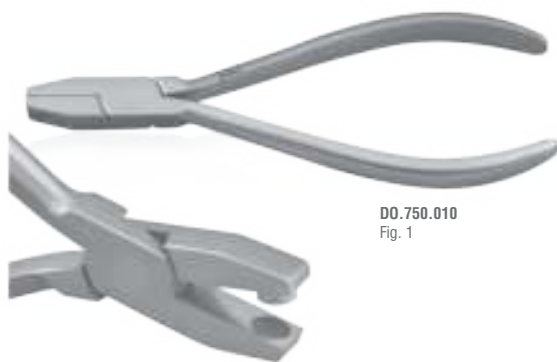

DO.750.010
Fig. 1



DO.750.020
Fig. 2

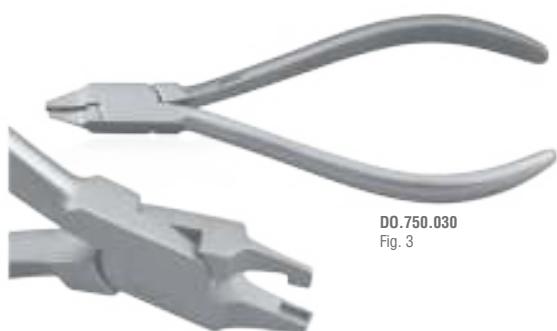

DO.750.030
Fig. 3

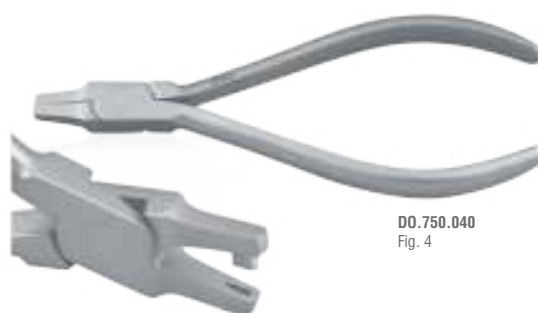

DO.750.040
Fig. 4



DO.750.050
Fig. 5



DO.750.060
Fig. 6



Pliers for "Removable Appliance Technique" / Pinze per ortodonzia mobile

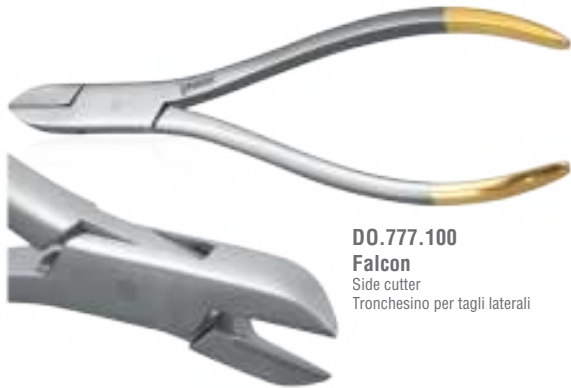

DO.777.100
Falcon
Side cutter
Tronchesino per tagli laterali

● 0.70 mm to 1.00 mm (.028" to .040")



DO.779.100
Falcon
End cutter
Tronchesino per tagli frontali

● 0.70 mm to 1.00 mm (.028" to .040")

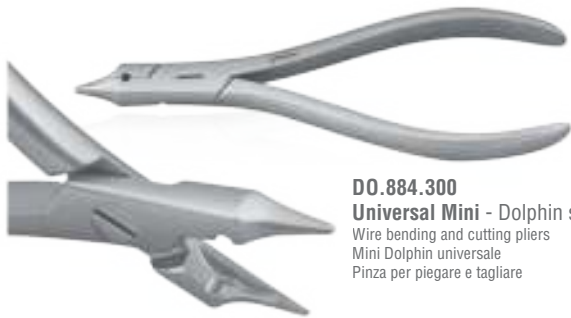

DO.884.300
Universal Mini - Dolphin style
Wire bending and cutting pliers
Mini Dolphin universale
Pinza per piegare e tagliare

● Bends / Piegare : 0.9 mm (.036")
Cuts / Taglia : 0.7 mm (.028")



DO.885.300
Universal - Dolphin style
Wire bending and cutting pliers
Dolphin universale
Pinza per piegare e tagliare

● Bends / Piegare : 0.9 mm (.036")
Cuts / Taglia : 0.7 mm (.028")



DO.886.300
Universal - Taper style
Wire bending and cutting pliers
Universale a punte coniche
Pinza per piegare e tagliare

● Bends / Piegare : 0.9 mm (.036")
Cuts / Taglia : 0.7 mm (.028")



DO.895.300
Waldsachs
Wire bending and cutting pliers
Pinza per piegare e tagliare

● Bends / Piegare : 0.9 mm (.036")
Cuts / Taglia : 0.7 mm (.028")

Pliers for "Removable Appliance Technique" / Pinze per ortodonzia mobile

Falcon

Heavy duty hard wire cutters
Compound action
Cut heavy wires with little force

Tronchesini per fili duri ad elevata resistenza
Grazie alle leve
taglia con poca forza anche fili grossi



DO.785.300
Small / Piccola
Stainless steel, autoclavable
Acciaio Inox, autoclavabile

● 0.87 mm to 1.1 mm (.028" to .045")



DO.786.300
Large / Grande
Stainless steel, autoclavable
Acciaio inox, autoclavabile

● 0.80 mm to 1.50 mm (.032" to .057")



DO.787.300
Small / Piccola
Stainless Steel, autoclavable
Acciaio Inox, autoclavabile

● 0.87 mm to 1.1 mm (.028" to .045")



DO.888.300
Universal
Parallel jaw pliers with side cutter, compound action
Powerful pliers easily cuts outer bow
of a facebow, serrated jaws assure
non-slip grip while bending

Pinza con punte parallele e tronchesino incorporato robusta
per facilitare il
taglio degli archi interni ed esterni
Le punte zigrinate evitano lo
scivolamento del filo durante la piegatura



Max. 1.80 mm (.071")



Pliers for "Removable Appliance Technique" / Pinze per ortodonzia mobile

Adams wire bending pliers
Tips of all Adams pliers parallel at 1mm opening
box joint, available in mini and maxi sizes

Pinze di Adams per piegare
Tutte le pinze di Adams hanno lo snodo a incastro sono disponibili nei
formati mini e maxi e hanno le punte parallele con apertura 1 mm.



Adams pliers with tungsten carbide tips
Pinze di Adams con riporti al carburo di tungsteno



DO.796.100
Adams Maxi
Fig. 64

● 0.36 mm to 0.81 mm (.014" to .032")
■ Max. 0.56 mm x 0.71 mm (.022" x .028")



DO.799.100
Adams Maxi
Fig. 65

● 0.36 mm to 0.81 mm (.014" to .032")
■ Max. 0.56 mm x 0.71 mm (.022" x .028")



DO.796.300
Adams Maxi
Fig. 64

● 0.36 mm to 0.81 mm (.014" to .032")
■ Max. 0.56 mm x 0.71 mm (.022" x .028")

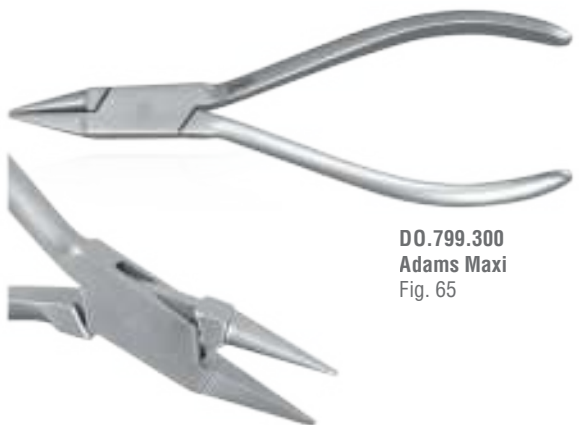

DO.799.300
Adams Maxi
Fig. 65

● 0.36 mm to 0.81 mm (.014" to .032")
■ Max. 0.56 mm x 0.71 mm (.022" x .028")



DO.795.300
Adams Mini

● 0.36 mm to 0.81 mm (.014" to .032")
■ Max. 0.56 mm x 0.71 mm (.022" x .028")



DO.798.300
Adams Mini

● 0.36 mm to 0.81 mm (.014" to .032")
■ Max. 0.56 mm x 0.71 mm (.022" x .028")

Pliers for "Removable Appliance Technique" / Pinze per ortodonzia mobile

Aderer 3-Jaw wire bending pliers
Precision aligned and contoured tips for consistent bends without damaging wire.



DO.806.300
Aderer - Mini

● 0.36 mm to 0.50 mm (.014" to .020")
■ Max. 0.53 mm x 0.64 mm (.021" x .020")

Pinza di Aderer a tre punte per piegare
La precisione e rifinitura delle punte consente di riprodurre pieghe uguali tra loro senza danneggiare il filo



DO.870.300
Schwarz Mini
Optical style, round and concave beaks.
Loop forming pliers
Pinza stile ottico per formare le anse con punte tonda/concava

● Max. 0.50 mm (.020")



DO.807.300
Aderer - Midi

● 0.36 mm to 0.71 mm (.014" to .025")
■ Max. 0.56 mm x 0.71 mm (.022" x .028")



DO.871.300
Schwarz Midi
Optical style, round and concave beaks.
Loop forming pliers
Pinza stile ottico per formare le anse con punte tonda/concava

● Max. 0.70 mm (.028")



DO.808.300
Aderer - Maxi

● 0.50 mm to 0.91 mm (.020" to .036")
■ Max. 0.56 mm x 0.71 mm (.022" x .028")



DO.872.300
Schwarz Maxi
Optical style, round and concave beaks.
Loop forming pliers
Pinza stile ottico per formare le anse con punte tonda/concava

● Max. 0.70 mm (.028")



Orthodontic Ortodonzia

Pliers for "Removable Appliance Technique" / Pinze per ortodonzia mobile



DO.874.300
Schwarz graduated
Optical style, round and concave beaks.
Loop forming pliers. Graduation prevents wire slippage.
Pinza stile ottico per formare le anse con punte tonda/concava. Le tacche prevengono lo scorrimento del filo.

● Max. 0.70 mm (.028")



DO.812.300
Angel
Bird beak lab. pliers
Tips parallel at 1mm opening
Pinza da laboratorio con punte a becco d'uccello. Le punte sono parallele con apertura 1 mm

● 0.36 mm to 0.71 mm (.014" to .028")
■ Max. 0.56 mm x 0.71 mm (.022" x .028")



DO.838.300
Fisher
Loop forming pliers
Pinza per formare anse

● 0.36 mm to 0.64 mm (.014" to .025")
■ Max. 0.53 mm x 0.64 mm (.021" x .025")



DO.830.300
Falcon
Flat nose wire bending pliers
Pinza per piegare con punte piatte

● 0.36 mm to 0.71 mm (.014" to .028")
■ Max. 0.56 mm x 0.71 mm (.022" x .028")



DO.850.300
Mckellops
Optical style, round and concave beaks.
Heavy loop forming pliers
Pinza stile ottico per formare anse grosse con punte tonda/concava

● Max. 0.80 mm (.032")



DO.824.300
Falcon
Wire bending pliers
Pinza per piegare

● 0.36 mm to 0.64 mm (.014" to .025")
■ Max. 0.53 mm x 0.64 mm (.021" x .025")

Pliers for "Removable Appliance Technique" / Pinze per ortodonzia mobile

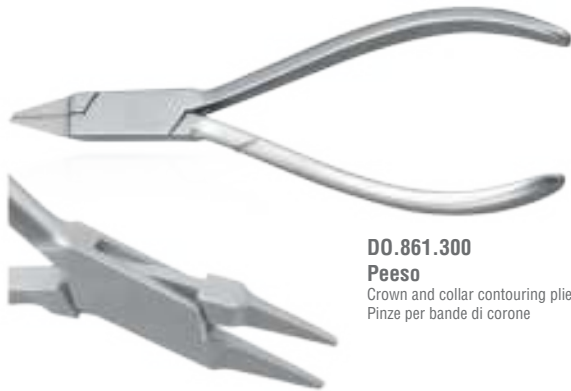

DO.861.300
Peeso
Crown and collar contouring pliers
Pinze per bande di corone



DO.860.300
Peeso
Round nose wire bending pliers
Pinza per piegare con punte tonde

● 0.36 mm to 0.71 mm (.014" to .028")
■ Max. 0.56 mm x 0.71 mm (.022" x .028")



DO.877.300
Schwarz
Arrow clasp forming pliers
Pinza per formare ganci a freccia

■ Max. 0.70 mm (.028")



DO.896.300
Young
Loop forming pliers
Pinza per formare le anse

● 0.36 mm to 0.71 mm (.014" to .028")
■ Max. 0.56 mm x 0.71 mm (.022" x .028")



DO.876.300
Schwarz
Arrow clasp bending pliers
Pinza per piegare ganci a freccia

■ Max. 0.70 mm (.028")



DO.810.300
Aderer
Facebow loop forming pliers
For forming loops in either inner or outer bows of facebow
Pinza per formare anse sugli archi extraorali
Per formare anse sugli archi interni ed esterni

■ Max. 1.60 mm (.063")



Pliers stands / Porta pinze



DO.964.010

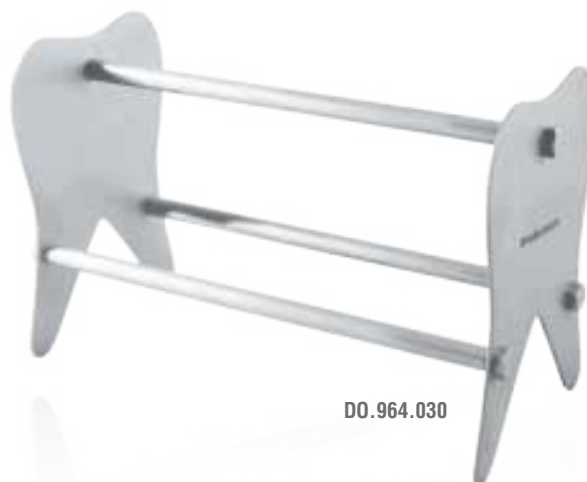

DO.964.030



DO.963.010
Mini
95 x 125 mm



DO.963.020
Midi
110 x 125 mm



DO.963.030
Maxi
155 x 125 mm



DO.963.040
X-Large
310 x 125 mm



Sterilization and Sundries
Sterlizzazione e Varie

Sterilization and Sundries

Sterilizzazione e Varie

Colour coding rings / Anelli di identificazione



Colour / Colori	Small / Piccoli	Large / Grandi	Pack / Conf.
Assorted / Assortiti	DZ.080.000	DZ.081.000	50 pcs / pz.
Black / Nero	DZ.080.010	DZ.081.010	50 pcs / pz.
Blue Dark / Blu	DZ.080.020	DZ.081.020	50 pcs / pz.
Blue Light / Celeste	DZ.080.030	DZ.081.030	50 pcs / pz.
Brown / Marrone	DZ.080.050	DZ.081.050	50 pcs / pz.
Grey / Grigio	DZ.080.080	DZ.081.080	50 pcs / pz.
Green / Verde	DZ.080.090	DZ.081.090	50 pcs / pz.
Orange / Arancio	DZ.080.110	DZ.081.110	50 pcs / pz.
Pink / Rosa	DZ.080.130	DZ.081.130	50 pcs / pz.
Red / Rosso	DZ.080.150	DZ.081.150	50 pcs / pz.
White / Bianco	DZ.080.170	DZ.081.170	50 pcs / pz.
Yellow / Giallo	DZ.080.180	DZ.081.180	50 pcs / pz.

• Small: inner Ø 4mm • Piccoli: Ø interno 4mm
 • Large: inner Ø 6mm • Grandi: Ø interno 6mm

Moderna Sterilization cassettes / Cassette per sterilizzare



DZ.092.050 5 instruments / 5 strumenti
DZ.092.070 7 instruments / 7 strumenti
DZ.092.080 8 instruments / 8 strumenti
DZ.092.100 10 instruments / 10 strumenti

Petite Sterilization cassettes / Cassette per sterilizzare



DZ.094.000 3 instruments / 3 strumenti
DZ.095.000 5 instruments / 5 strumenti
DZ.095.010 7 instruments / 7 strumenti
DZ.095.020 10 instruments / 10 strumenti

TWIST-LOCK Sterilization cassettes / Cassette per sterilizzare

TWIST-LOCK
 Rotate to open
 Ruotare per aprire



Mini 182 x 72 x 34 mm

Blue / Blu	DZ.086.010
Green / Verde	DZ.086.013
Red / Rosso	DZ.086.015
Yellow / Giallo	DZ.086.019

5 instruments / 5 strumenti



Midi 182 x 144 x 34 mm

Blue / Blu	DZ.086.020
Green / Verde	DZ.086.023
Red / Rosso	DZ.086.025
Yellow / Giallo	DZ.086.029

10 instruments / 10 strumenti



Maxi 288 x 182 x 34 mm

Blue / Blu	DZ.086.030
Green / Verde	DZ.086.033
Red / Rosso	DZ.086.035
Yellow / Giallo	DZ.086.039

20 instruments / 20 strumenti

Instrument trays aluminum Maxi Vassoi porta strumenti in alluminio Maxi

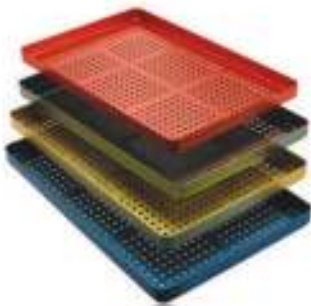

(284 x 183 x 17mm)

Blue / Blu	DZ.400.010
Golden / Oro	DZ.400.020
Green / Verde	DZ.400.030
Red / Rosso	DZ.400.040
Silver / Argento	DZ.400.050

Perforated trays / Vassoio perforato



(284 x 183 x 17mm)

Blue / Blu	DZ.401.010
Golden / Oro	DZ.401.020
Green / Verde	DZ.401.030
Red / Rosso	DZ.401.040
Silver / Argento	DZ.401.050

Solid trays / Vassoio non perforato



(288 x 187 x 29mm)

Silver / Argento	DZ.402.010
------------------	-------------------

Perforated cover / Coperchio perforato



(288 x 187 x 29mm)

Silver / Argento	DZ.402.020
------------------	-------------------

Solid cover / Coperchio non perforato

Aluminum rack Maxi Rastrelliera in alluminio Maxi



DZ.435.020
for 6 Maxi trays / per 6 vassoi Maxi
295 x 190 x 270mm

Aluminum instrument racks Maxi Griglia porta strumenti in alluminio Maxi



DZ.430.070
for 15 instruments
per 15 strumenti

DZ.430.071
for 17 instruments
per 17 strumenti

DZ.430.080
for 23 instruments
per 23 strumenti

Instrument trays aluminum Midi Vassoi porta strumenti in alluminio Midi

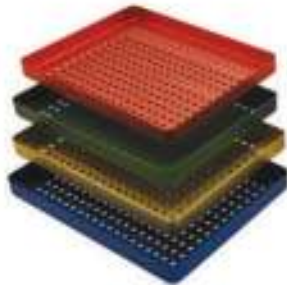

(183 x 140 x 17 mm)

Blue / Blu	DZ.405.010
Golden / Oro	DZ.405.020
Green / Verde	DZ.405.030
Red / Rosso	DZ.405.040
Silver / Argento	DZ.405.050

Perforated trays / Vassoio perforato



(183 x 140 x 17mm)

Blue / Blu	DZ.406.010
Golden / Oro	DZ.406.020
Green / Verde	DZ.406.030
Red / Rosso	DZ.406.040
Silver / Argento	DZ.406.050

Solid trays / Vassoio non perforato



(187 x 145 x 25 mm)

Silver / Argento	DZ.407.010
------------------	-------------------

Perforated cover / Coperchio perforato



(187 x 145 x 25 mm)

Silver / Argento	DZ.407.020
------------------	-------------------

Solid cover / Coperchio non perforato

Aluminum rack Midi Rastrelliera in alluminio Midi



DZ.435.010
for 6 Midi trays / per 6 vassoi Midi
150 x 180 x 270mm

Aluminum instrument racks Midi Griglie porta strumenti in alluminio Midi



DZ.408.020
for 4 instruments
per 4 strumenti

DZ.408.010
for 8 instruments
per 8 strumenti

Sterilization and Sundries

Sterilizzazione e Varie

Instrument trays aluminum Mini / Vassoi porta strumenti in alluminio Mini

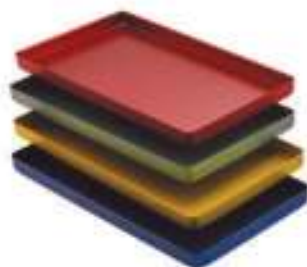

(180 x 100 x 11 mm)

Blue / Blu	DZ.410.010
Golden / Oro	DZ.410.020
Green / Verde	DZ.410.030
Red / Rosso	DZ.410.040
Silver / Argento	DZ.410.050

Solid trays / Vassoio non perforato

(182 x 103 x 13 mm)

Silver / Argento	DZ.411.020
------------------	-------------------

Solid cover / Coperchio non perforato



Aluminum inserts / Vaschette in alluminio



DZ.415.010
Fig. 1
49 x 26 x 10mm



DZ.415.020
Fig. 2
49 x 26 x 10mm



DZ.415.030
Fig. 3
59 x 49 x 10mm



DZ.415.040
Fig. 4
59 x 49 x 10mm

Instrument trays stainless steel Maxi / Vassoi porta strumenti in acciaio inox Maxi



DZ.430.000 Maxi set 1
Solid cover + Perforated tray + Rack for 15 instruments
Coperchio non perforato + Vassoio perforato + Griglia per 15 strumenti
288 x 187 x 40 mm



DZ.431.000 Maxi set 2
Perforated cover + Perforated tray + Rack for 15 instruments
Coperchio perforato + Vassoio perforato + Griglia per 15 strumenti
288 x 187 x 40 mm



DZ.432.000 Maxi set 3
Solid cover + Solid tray + Rack for 15 instruments
Coperchio non perforato + Vassoio non perforato + Griglia per 15 strumenti
288 x 187 x 40 mm



DZ.430.010
Solid cover / Coperchio non perforato
288 x 187 x 29 mm



DZ.430.020
Perforated cover / Coperchio perforato
288 x 187 x 29 mm



DZ.430.030
Perforated tray / Vassoio perforato
284 x 183 x 19 mm



DZ.430.040
Solid tray / Vassoio non perforato
284 x 183 x 19 mm

Instrument trays stainless steel Midi / Vassoi porta strumenti in acciaio inox Midi



DZ.425.010 Solid cover only / Solo coperchio non perforato
DZ.425.020 Perforated cover only / Solo coperchio perforato
187 x 145 x 25mm

DZ.425.030 Perforated tray only / Solo vassoio perforato
DZ.425.040 Solid tray only / Solo vassoio non perforato
183 x 140 x 17mm

Instrument trays stainless steel / Vassoi porta strumenti in acciaio inox



DZ.420.010
Fig. 1
185 x 80 x 15 mm



DZ.420.020
Fig. 2
190 x 100 x 17 mm



DZ.420.030
Fig. 3
190 x 100 x 25 mm



DZ.420.031
Cover for DZ.420.030
Coperchio per DZ.420.030



DZ.420.040
Fig. 4
190 x 100 x 15 mm



DZ.420.050
Fig. 5
190 x 135 x 15 mm

Instrument trays stainless steel Vassoi porta strumenti in acciaio inox



Code / Codice	A mm	B mm	C mm
SH.152.075	125	75	25
SH.155.120	150	120	30
SH.220.150	200	150	40
SH.227.200	250	200	50
SH.234.250	350	250	50
SH.242.350	455	350	50

Instrument boxes stainless steel Contenitori per strumenti in acciaio inox



Code / Codice	A mm	B mm	C mm
DZ.465.000	180	90	30
DZ.470.000	180	100	30
SH.056.100	200	100	50
SH.056.125	200	125	50
SH.062.125	250	125	60
SH.062.150	250	150	60

Instrument box perforated stainless steel Contenitore per strumenti perforato in acciaio inox



DZ.467.000
180 x 90 x 30 mm

Kidney trays stainless steel Vassoi reniformi in acciaio inox



Code / Codice	mm
SH.570.150	150
SH.570.180	180
SH.570.200	200
SH.570.250	250

Bowls stainless steel Tazze in acciaio inox



Code / Codice	mm
SH.606.090	90
SH.606.100	100
SH.606.125	125
SH.606.150	150
SH.606.200	200

Gallipots stainless steel Tazze in acciaio inox



Code / Codice	ml
SH.600.020	50
SH.600.040	100
SH.600.060	150
SH.600.090	225

Sterilization and Sundries Sterilizzazione e Varie

Forceps jars / Contenitori per pinze

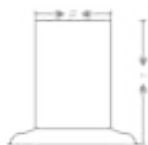

Code / Codice	Ø mm	h mm
SH.755.110	50	110
SH.755.150	50	150

Sterilizing forceps / Pinze per sterilizzazione

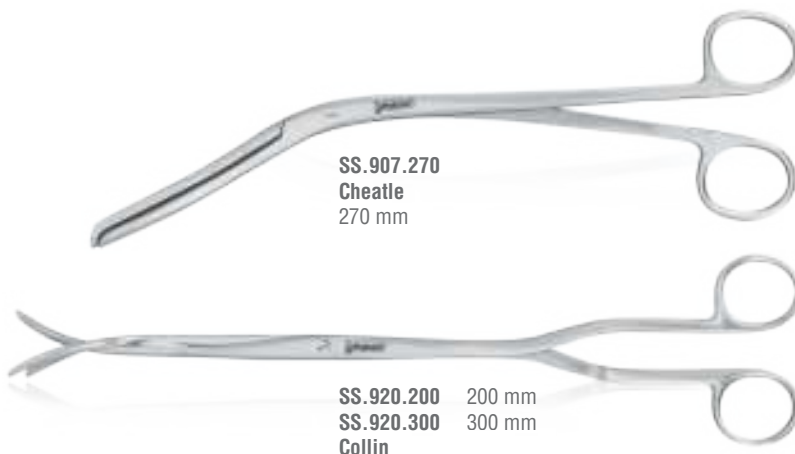

SS.907.270
Cheate
270 mm

SS.920.200 200 mm
SS.920.300 300 mm
Collin

Drinking cup dispensers / Distributori di bicchieri



DZ.201.010



DZ.200.010

Silver / Argento
85 x 85 x 360mm
for 70 cups / per 70 bicchieri



DZ.200.020

White / Bianco
85 x 85 x 360mm
for 70 cups / per 70 bicchieri

Glass products / Prodotti in vetro

Glass bottles set with stainless steel stand
Set di kappen in vetro con base in acciaio inox



DZ.8510.00

Glass dappen pots Dappen in vetro



DZ.8505.01

Blue / Blu
DZ.8505.02
Clear / Trasparente



DZ.8505.03

Green / Verde
DZ.8505.04
Pink / Rosa

Mortar and pestle / Mortaio e Pestello



DZ.9950.00

Universal tip holder / Base universale

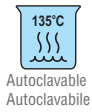

35 pits / 35 posizioni

Orange / Arancione	DZ.064.010
Red / Rosso	DZ.064.020
Yellow / Giallo	DZ.064.030
Pink / Rosa	DZ.064.040
Blue Dark / Blu	DZ.064.050
Black / Nero	DZ.064.060

Cover 30 mm / Coperchio 30 mm

Orange / Arancione	DZ.064.015
Red / Rosso	DZ.064.025
Yellow / Giallo	DZ.064.035
Pink / Rosa	DZ.064.045
Blue Dark / Blu	DZ.064.055
Black / Nero	DZ.064.065

Cover 55 mm / Coperchio 55 mm



Brass burs stands, autoclavable Porta frese in ottone, autoclavabile



DZ.060.010
FG for 12 burs
Per 12 frese FG



DZ.060.020
CA/RA for 12 burs
Per 12 frese CA/RA



DZ.061.010
FG for 48 burs
Per 48 frese FG

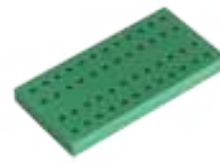

DZ.061.020
CA/RA for 48 burs
Per 48 frese CA/RA



DZ.061.030
FG & CA/RA for 48 burs
Per 48 frese FG e CA/RA

Burs disinfecting boxes Contenitori disinfezza frese



DZ.050.010
Plastic / Plastica
Ø 85 mm x H 70 mm



DZ.051.010
Stainless steel / Acciaio inox
Ø 76 mm x H 35 mm

Mesh burs holder Contenitore per frese in rete metallica



DZ.052.010
Ø 35mm x L 150 mm

Bur holding tweezers Pinzetta per trattenere le frese



DZ.055.010
165 mm

Sterilization and Sundries

Sterilizzazione e Varie

Cotton rolls dispensers / Distributori rulli salivari



Blue / Blu	DZ.525.010
Green / Verde	DZ.525.020
Red / Rosso	DZ.525.030
White / Bianco	DZ.525.040
Yellow / Giallo	DZ.525.050

Cotton rolls holder stainless steel Porta rulli salivari in acciaio inox



DZ.530.010

Cotton dispensers stainless steel Distributori di cotone in acciaio inox



DZ.540.010



DZ.540.020

Cotton pellet dispenser stainless steel Distributore di palline di cotone in acciaio inox



DZ.532.000
40 x 40 x 50 mm

Cotton dispensers aluminum / Distributori di cotone in alluminio



DZ.535.010
Blue / Blu



DZ.535.020
Golden / Oro



DZ.535.030
Green / Verde



DZ.535.040
Red / Rosso



DZ.535.050
Silver / Argento

Cotton waste receiver stainless steel Raccogliatore per cotone piccolo in acciaio inox



DZ.544.010

Cotton container stainless steel Contenitore di cotone in acciaio inox



SH.720.100
Ø100 x H 100 mm

Bib chains / Catenelle per salviette



DZ.945.020

X-Ray clip / Pinzetta per radiografie



DZ.970.010
Fig. 1



DZ.945.050

X-Ray hangers / Appendiradiografie



DZ.972.100
Fig. 10
10 Clips / 10 Pinzette



DZ.972.140
Fig. 14
14 Clips / 14 Pinzette

Key rings / Porta chiavi



ZP.135.010
Laughing tooth
Dente con sorriso



ZP.135.020
Rooted tooth
Dente con radici



ZP.135.030
Perforate impression tray
Porta impronta perforata



ZP.135.040
Solid impression tray
Porta impronta liscia

Sterilization and Sundries

Sterilizzazione e Varie

Posters / Posters

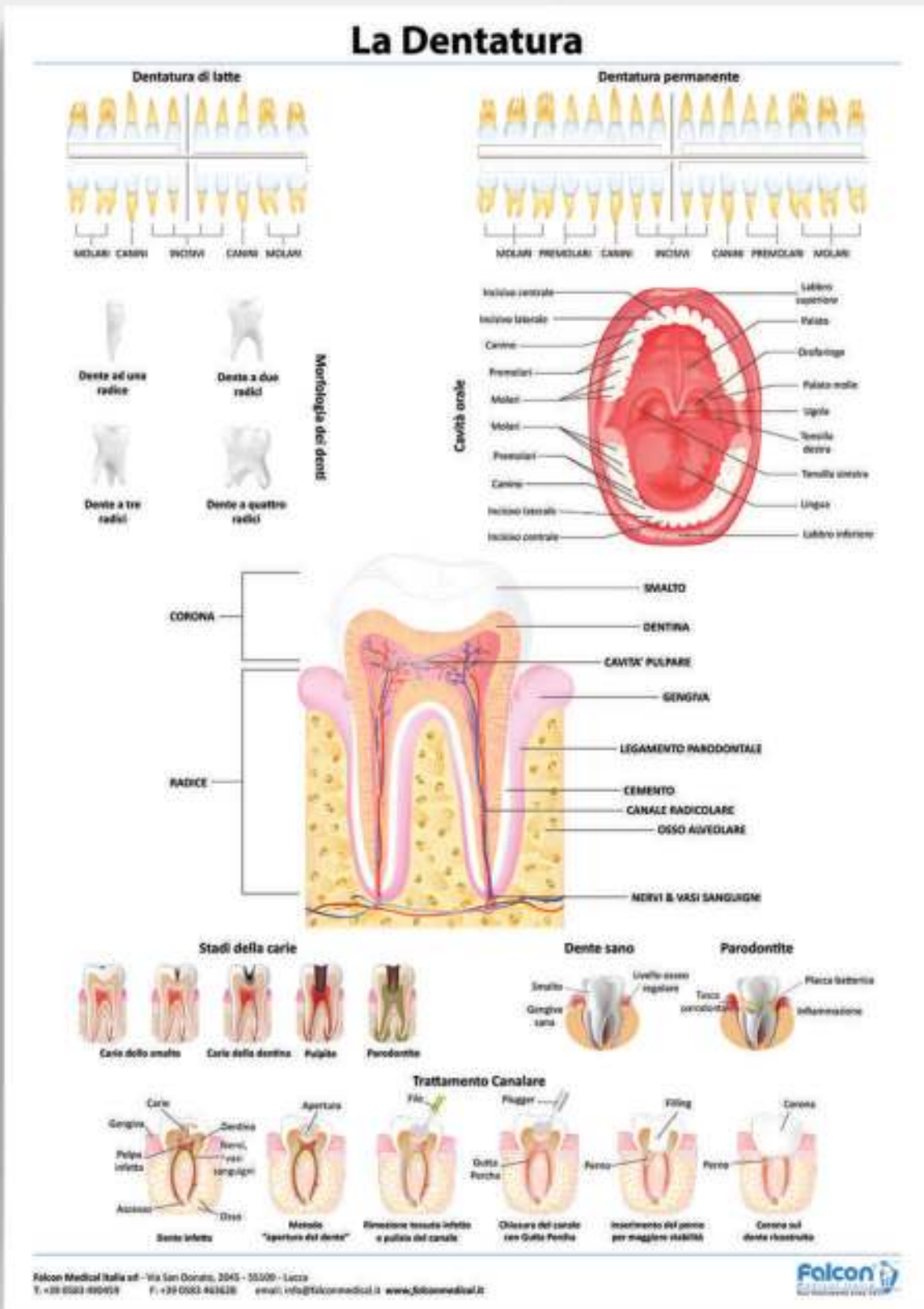

ZP.100.010
 345 x 495 mm
 Dentation- Italian version
 La dentatura - Versione italiana

ZP.100.020
 345 x 495 mm
 Dentation- English version
 La dentatura - Versione inglese



**Index
Indice**

Code Index

Indice Per Codice

Code/Codice	Page/Pagina	Code/Codice	Page/Pagina	Code/Codice	Page/Pagina	Code/Codice	Page/Pagina	Code/Codice	Page/Pagina
BA.225.150	174	BF.411.090	143	BM.183.180	132	BN.598.140	148	BS.540.115	139
BA.225.300	174	BF.431.090	143	BM.420.150	133	BN.598.150	148	BS.541.115	139
BD.010.150	141	BF.431.110	143	BM.420.180	133	BN.598.160	148	BS.542.115	139
BD.013.150	141	BF.431.130	143	BM.421.150	133	BN.598.180	148	BS.543.115	139
BD.054.120	141	BH.210.100	144	BM.421.180	133	BN.598.200	148	BS.549.115	139
BD.104.120	141	BH.211.100	144	BM.470.150	133	BN.674.140	148	BS.636.160	139
BD.200.120	141	BH.220.125	144	BM.470.180	133	BN.689.160	148	BS.637.160	139
BD.250.120	141	BH.221.125	144	BM.471.150	133	BN.700.120	148	BS.639.160	139
BD.318.160	141	BH.224.125	144, 179	BM.471.180	133	BN.712.140	148	BS.650.120	140
BD.319.160	141	BH.225.125	144, 179	BM.550.145	134	BN.712.170	148	BS.650.145	140
BD.350.100	141	BH.226.125	144	BM.550.185	134	BN.714.140	148	BS.651.120	140
BD.351.100	141	BH.227.125	144	BM.551.145	134	BN.714.170	148	BS.651.145	140
BD.360.120	141	BH.266.145	144	BM.551.185	134	BN.716.200	148	BS.652.120	140
BD.360.150	141	BH.267.145	144	BM.650.150	134	BP.050.145	150	BS.652.145	140
BD.370.120	141	BH.270.145	144	BM.650.180	134	BP.055.145	150	BS.653.120	140
BD.370.150	141	BH.271.145	144	BM.651.150	134	BQ.041.010	150	BS.653.145	140
BD.380.175	142	BH.300.160	144	BM.651.180	134	BQ.041.020	150	BS.654.120	140
BD.381.175	142	BH.301.160	144	BM.652.150	134	BQ.045.150	150	BS.654.145	140
BD.394.125	141	BH.306.160	144	BM.652.180	134	BQ.100.010	149	BS.655.120	140
BD.395.125	141	BH.307.160	144	BM.653.150	134	BQ.100.020	149	BS.655.145	140
BD.500.105	142	BH.330.190	144	BM.653.180	134	BQ.100.030	149	BS.670.145	140
BD.500.115	142	BH.331.190	144	BM.700.150	134	BQ.100.040	149	BS.671.145	140
BD.500.130	142	BH.480.145	144	BM.700.180	134	BQ.103.010	149	BS.756.145	140
BD.500.145	142	BH.480.165	144	BM.701.150	134	BQ.103.020	149	BS.757.145	140
BD.500.150	142	BH.481.145	144	BM.701.180	134	BQ.103.030	149	BS.762.145	139
BD.500.160	142	BH.481.165	144	BN.150.140	145	BQ.103.040	149	BS.763.145	139
BD.500.180	142	BH.486.145	144	BN.151.140	145	BQ.150.160	149	BS.880.090	140
BD.500.200	142	BH.487.145	144	BN.152.140	145	BQ.151.160	149	BS.880.130	140
BD.500.250	142	BH.490.145	144	BN.152.180	145	BQ.250.120	149	BS.884.140	140
BD.500.305	142	BH.491.145	144	BN.153.140	145	BQ.284.210	149	BS.912.110	162
BD.600.100	142	BK.150.040	136	BN.154.140	145	BQ.454.010	150	BS.915.095	162
BD.601.100	142	BK.150.050	136	BN.155.140	145	BQ.454.020	150	BS.920.120	162
BD.610.120	142	BK.150.060	136	BN.156.140	145	BQ.454.030	150	BS.921.120	162
BD.610.150	142	BK.150.070	136	BN.157.140	145	BQ.454.040	150	BS.943.090	140
BD.620.120	142	BK.500.100	136	BN.158.140	145	BQ.454.050	150	BS.943.110	140
BD.620.150	142	BK.500.110	136	BN.200.130	145	BQ.458.010	150	BS.943.145	140
BD.626.120	142	BK.500.120	136	BN.204.125	145	BQ.458.020	150	BS.943.180	140
BD.630.175	142	BK.500.122	136	BN.230.150	145	BQ.458.030	150	BS.964.010	140
BD.631.175	142	BK.500.130	136	BN.235.150	145	BQ.458.040	150	DA.010.180	68
BD.644.125	142	BK.500.150	136	BN.236.150	145	BQ.458.050	150	DA.020.180	68
BD.645.125	142	BK.500.152	136	BN.236.151	145	BQ.468.050	150	DA.021.180	68
BD.750.115	142	BK.550.030	136	BN.237.150	145	BQ.468.060	150	DA.035.000	68
BD.750.130	142	BK.552.030	136	BN.238.150	146	BQ.472.050	150	DA.060.180	71
BD.750.145	142	BK.556.030	136	BN.290.145	146	BQ.472.060	150	DA.094.180	68
BD.750.160	142	BK.580.070	136	BN.298.160	146	BQ.680.010	150	DA.095.180	71
BD.750.180	142	BK.584.070	136	BN.298.180	146	BQ.680.020	150	DA.115.180	69
BD.750.200	142	BK.600.050	136	BN.374.140	146	BQ.680.030	150	DA.145.180	71
BD.904.020	133	BK.610.050	136	BN.396.180	146	BR.040.070	150	DA.315.180	69
BD.904.030	133	BK.612.050	136	BN.412.140	146	BR.041.070	150	DA.517.180	69
BD.904.040	133	BK.613.050	136	BN.412.170	146	BR.074.135	150	DA.520.180	72
BD.904.050	133	BK.650.040	136	BN.414.140	146	BR.077.135	150	DA.557.180	69
BD.904.055	133	BK.740.015	110	BN.414.170	146	BS.100.115	137	DA.560.180	72
BD.904.070	133	BK.742.015	110	BN.418.140	146	BS.101.115	137	DA.561.180	72
BD.992.140	143	BK.750.150	136	BN.418.170	146	BS.107.115	137	DA.595.180	70
BD.993.135	143	BL.539.160	148	BN.431.140	146	BS.118.115	137	DA.620.180	73
BD.994.125	143	BM.042.100	132	BN.431.170	146	BS.119.115	137	DA.635.180	70
BD.995.060	34	BM.042.130	132	BN.452.140	147	BS.136.160	137	DA.705.180	70
BF.046.200	143	BM.044.100	132	BN.453.140	147	BS.137.160	137	DA.721.180	72
BF.046.250	143	BM.047.130	132	BN.454.140	147	BS.200.145	137	DA.735.180	72
BF.047.200	143	BM.100.180	132	BN.455.140	147	BS.201.145	137	DA.801.180	70
BF.047.250	143	BM.101.180	132	BN.457.140	147	BS.250.115	138	DA.806.180	70
BF.056.200	143	BM.103.180	132	BN.458.140	147	BS.251.115	138	DA.819.180	73
BF.056.250	143	BM.120.155	132	BN.464.130	147	BS.257.115	138	DA.820.180	73
BF.057.200	143	BM.121.155	132	BN.506.125	147	BS.430.160	138	DA.821.180	73
BF.057.250	143	BM.180.150	132	BN.546.150	147	BS.431.160	138	DA.835.180	73
BF.122.250	143	BM.180.180	132	BN.580.145	147	BS.504.120	132	DA.980.000	74
BF.123.250	143	BM.181.150	132	BN.596.140	147	BS.505.120	132	DA.990.000	74
BF.407.090	143	BM.181.180	132	BN.597.140	147	BS.506.115	132	DB.9001.235	171

Code Index

Indice Per Codice

Code/Codice	Page/Pagina	Code/Codice	Page/Pagina	Code/Codice	Page/Pagina	Code/Codice	Page/Pagina	Code/Codice	Page/Pagina
DB.9001.405	171	DD.201.230	7	DD.506.030	2	DD.944.015	10	DE.070.440	87
DB.9113.603	170	DD.201.320	7	DD.506.040	2	DD.946.010	10	DE.070.450	87
DB.9113.605	172	DD.201.650	7	DD.506.050	2	DD.978.130	10	DE.086.010	88
DB.9122.235	171	DD.211.060	7	DD.509.020	2	DD.979.130	10	DE.086.011	91
DB.9123.233	170	DD.211.061	7	DD.509.030	2	DD.996.061	11	DE.086.020	88
DB.9141.233	170	DD.211.090	7	DD.509.040	2	DD.996.090	11	DE.086.021	91
DB.9142.234	171	DD.211.230	7	DD.509.050	2	DD.996.230	11	DE.086.025	86
DB.9144.603	170	DD.211.320	7	DD.515.040	2	DD.997.060	11	DE.086.030	88
DB.9144.605	172	DD.303.020	7	DD.515.050	2	DD.997.062	12	DE.086.031	91
DB.9144.608	172	DD.303.030	7	DD.520.010	4	DD.997.090	11	DE.086.035	86
DB.9145.232	171	DD.303.031	7	DD.522.010	4	DD.997.092	12	DE.089.010	88
DB.9145.233	170	DD.303.050	7	DD.522.015	4	DD.997.230	11	DE.089.020	88
DB.9145.235	171	DD.303.060	7	DD.528.010	3	DD.997.232	12	DE.089.030	88
DB.9185.234	171	DD.303.080	7	DD.528.020	3	DE.015.301	87	DE.095.015	85
DB.9187.233	170	DD.303.090	7	DD.528.030	3	DE.015.302	87	DE.095.025	85
DB.9187.235	171	DD.303.100	7	DD.528.040	3	DE.015.303	87	DE.096.015	85
DB.9187.454	171	DD.303.110	7	DD.528.050	3	DE.015.304	87	DE.096.035	85
DB.9198.233	170	DD.303.120	7	DD.528.060	3	DE.025.010	89	DE.096.045	85
DB.9199.232	171	DD.303.160	7	DD.528.070	3	DE.025.011	91	DE.096.065	85
DB.9199.234	171	DD.303.170	7	DD.528.080	3	DE.025.015	85	DE.096.075	85
DB.9199.235	171	DD.303.171	7	DD.528.090	3	DE.025.020	89	DE.100.010	88
DB.9200.402	171	DD.303.230	7	DD.528.100	4	DE.025.030	89	DE.100.020	88
DB.9200.403	170	DD.313.060	7	DD.528.110	4	DE.025.040	89	DE.100.030	88
DB.9200.405	172	DD.313.090	7	DD.528.120	4	DE.025.050	89	DE.100.040	88
DB.9200.408	172	DD.313.110	7	DD.528.130	4	DE.025.060	89	DE.110.010	91
DB.9200.603	170	DD.313.160	7	DD.530.010	4	DE.025.061	91	DE.110.020	91
DB.9200.604	171	DD.313.230	7	DD.532.080	4	DE.025.065	85	DE.115.010	90
DB.9200.605	172	DD.350.081	5	DD.540.010	4	DE.025.070	89	DE.115.020	90
DB.9201.503	170	DD.350.091	5	DD.540.015	4	DE.025.071	91	DE.115.030	90
DB.9201.505	172	DD.350.171	5	DD.540.020	4	DE.025.075	85	DE.117.010	90
DB.9201.605	172	DD.350.231	5	DD.545.010	4	DE.025.080	89	DE.117.020	90
DB.9201.608	172	DD.350.291	5	DD.545.015	4	DE.025.090	89	DE.117.030	90
DB.9225.233	170	DD.451.113	8	DD.550.032	8	DE.025.100	89	DE.118.021	90
DB.9237.232	171	DD.451.123	8	DD.601.141	8	DE.026.010	89	DE.118.022	90
DB.9237.233	170	DD.451.230	8	DD.601.142	8	DE.026.020	89	DE.153.040	88
DB.9237.603	170	DD.451.233	8	DD.601.233	8	DE.026.030	89	DE.153.050	88
DB.9237.605	172	DD.451.235	8	DD.701.020	9	DE.027.010	89	DE.154.010	91
DB.9250.234	171	DD.451.239	8	DD.701.080	9	DE.027.020	89	DE.154.020	91
DB.9257.233	170	DD.468.010	14	DD.701.110	9	DE.027.030	89	DE.155.015	88
DB.9275.603	170	DD.468.020	14	DD.701.111	9	DE.028.010	89	DE.155.017	88
DB.9275.604	171	DD.468.030	14	DD.701.115	9	DE.028.020	89	DE.155.045	88
DB.9275.605	172	DD.468.040	14	DD.701.120	9	DE.028.030	89	DE.155.047	88
DB.9275.608	172	DD.468.050	14	DD.701.127	9	DE.029.010	89	DE.155.340	88
DB.9277.605	172	DD.468.060	14	DD.701.128	9	DE.029.020	89	DE.155.347	88
DB.9289.233	170	DD.468.070	14	DD.701.129	9	DE.029.030	89	DE.190.050	90
DB.9292.232	171	DD.470.010	15	DD.701.158	9	DE.030.010	87	DE.190.055	86
DB.9292.233	170	DD.470.011	15	DD.701.159	9	DE.030.020	87	DE.190.070	90
DB.9292.235	171	DD.470.020	15	DD.701.180	9	DE.030.030	87	DE.190.075	86
DD.101.020	6	DD.470.021	15	DD.701.263	9	DE.030.040	87	DE.190.080	90
DD.101.030	6	DD.470.030	15	DD.711.073	9	DE.030.050	87	DE.190.085	86
DD.101.050	6	DD.470.031	15	DD.721.131	9	DE.030.060	87	DE.247.010	91
DD.140.011	5	DD.470.040	15	DD.721.132	9	DE.047.200	90	DE.255.060	91
DD.140.021	5	DD.471.010	16	DD.721.133	9	DE.047.210	90	DE.255.070	91
DD.140.031	5	DD.471.020	16	DD.721.134	9	DE.047.220	90	DE.265.320	92
DD.150.160	6	DD.472.010	16	DD.731.232	9	DE.050.011	87	DE.265.321	92
DD.150.170	6	DD.472.020	16	DD.731.234	9	DE.050.015	86	DE.265.322	92
DD.150.171	6	DD.475.030T	18	DD.735.230	9	DE.050.021	87	DE.265.323	92
DD.151.623	6	DD.475.040T	18	DD.750.151	5	DE.050.025	86	DE.265.350	92
DD.155.160	177	DD.475.050T	18	DD.890.010	10	DE.050.031	87	DE.265.351	92
DD.160.170	6	DD.475.060T	18	DD.900.150	10	DE.050.035	86	DE.270.015	92
DD.161.050	6	DD.475.070T	18	DD.901.150	10	DE.060.300	90	DE.270.017	92
DD.181.023	6	DD.475.080T	18	DD.909.050	10	DE.060.305	86	DE.270.115	92
DD.201.060	7	DD.475.090T	18	DD.909.055	10	DE.060.310	90	DE.270.117	92
DD.201.061	7	DD.494.000	2	DD.911.050	10	DE.060.315	86	DE.270.125	92
DD.201.080	7	DD.495.000	2	DD.929.050	10	DE.070.250	87	DE.270.127	92
DD.201.081	7	DD.503.040	2	DD.934.010	10	DE.070.260	87	DE.270.135	92
DD.201.090	7	DD.503.050	2	DD.934.015	10	DE.070.310	87	DE.270.137	92
DD.201.170	7	DD.506.020	2	DD.944.010	10	DE.070.320	87	DE.270.145	92

Code Index

Indice Per Codice

Code/Codice	Page/Pagina	Code/Codice	Page/Pagina	Code/Codice	Page/Pagina	Code/Codice	Page/Pagina	Code/Codice	Page/Pagina
DE.270.147	92	DE.751.450	101	DE.929.010	80	DI.400.010	157	DI.756.010	154
DE.275.145	93	DE.751.510	101	DE.930.000	80	DI.400.020	157	DI.756.020	154
DE.285.065	86	DE.753.490	101	DE.930.010	80	DI.400.030	157	DI.756.030	154
DE.285.075	86	DE.753.590	101	DE.930.020	80	DI.410.010	157	DI.756.040	154
DE.285.115	86	DE.800.000	103	DE.930.030	80	DI.410.020	157	DI.756.050	154
DE.290.010	93	DE.800.010	102	DE.930.040	80	DI.410.030	157	DI.756.060	154
DE.290.011	93	DE.800.070	102	DE.930.050	80	DI.450.000	157	DI.761.010	155
DE.290.015	86	DE.800.130	102	DE.930.060	80	DI.500.010	157	DI.761.020	155
DE.290.020	93	DE.800.170	102	DE.930.070	80	DI.500.020	157	DI.761.030	155
DE.290.021	93	DE.800.180	102	DE.930.080	80	DI.500.030	157	DI.761.040	155
DE.290.025	86	DE.800.220	102	DE.930.090	80	DI.510.010	157	DI.761.050	155
DE.290.030	93	DE.800.331	103	DE.930.110	80	DI.510.020	157	DI.761.060	155
DE.290.031	93	DE.800.511	103	DE.930.210	80	DI.510.030	157	DI.766.010	155
DE.290.035	86	DE.800.670	103	DE.930.220	80	DI.520.010	157	DI.766.020	155
DE.500.001	95	DE.800.790	103	DE.930.230	80	DI.520.020	157	DI.766.030	155
DE.500.137	94	DE.881.225	104	DE.930.240	80	DI.520.030	157	DI.766.040	155
DE.500.227	94	DE.881.227	104	DE.930.250	80	DI.530.010	157	DI.766.050	155
DE.500.307	94	DE.898.010	104	DE.930.260	80	DI.530.020	157	DI.766.060	155
DE.500.337	94	DE.898.020	104	DE.930.270	80	DI.530.030	157	DI.771.000	154
DE.500.370	94	DE.900.010	104	DE.930.280	80	DI.550.000	157	DI.771.060	154
DE.500.380	94	DE.900.020	104	DE.930.290	80	DI.560.000	157	DI.771.080	154
DE.500.390	94	DE.910.340	81	DE.931.010	80	DI.600.000	156	DI.781.000	155
DE.500.395	94	DE.910.341	81	DE.931.020	80	DI.600.010	156	DI.781.060	155
DE.500.397	95	DE.910.343	82	DE.975.010	104	DI.600.020	156	DI.781.080	155
DE.500.517	95	DE.910.344	82	DE.975.020	104	DI.600.030	156	DI.800.010	156
DE.650.000	96	DE.910.350	81	DE.999.001	84	DI.600.040	156	DI.800.020	156
DE.650.030	96	DE.910.351	81	DE.999.002	84	DI.610.000	156	DI.800.030	156
DE.650.050	96	DE.910.353	82	DI.001.000	152	DI.610.010	156	DI.800.040	156
DE.650.060	96	DE.910.354	82	DI.002.000	152	DI.610.020	156	DI.800.050	156
DE.650.070	96	DE.910.360	81	DI.004.025	152	DI.610.030	156	DI.801.010	153
DE.650.517	96	DE.910.361	81	DI.004.035	152	DI.610.040	156	DI.801.020	153
DE.651.370	96	DE.910.363	82	DI.005.010	152	DI.640.000	156	DI.801.030	153
DE.651.390	96	DE.910.364	82	DI.005.020	152	DI.701.010	154	DI.801.040	153
DE.750.000	101	DE.910.674	82	DI.006.020	152	DI.701.020	154	DI.801.050	153
DE.750.010	97	DE.910.794	82	DI.009.010	152	DI.701.030	154	DI.810.010	156
DE.750.020	97	DE.917.010	76	DI.010.017	152	DI.701.040	154	DI.810.020	156
DE.750.040	97	DE.917.020	76	DI.200.010	156	DI.701.050	154	DI.810.030	156
DE.750.070	97	DE.917.030	76	DI.200.020	156	DI.701.060	154	DI.810.040	156
DE.750.080	97	DE.917.040	76	DI.200.030	156	DI.706.010	154	DI.810.050	156
DE.750.130	97	DE.917.050	76	DI.210.010	156	DI.706.020	154	DI.811.010	153
DE.750.170	97	DE.917.060	76	DI.210.020	156	DI.706.030	154	DI.811.020	153
DE.750.180	97	DE.917.070	76	DI.210.030	156	DI.706.040	154	DI.811.030	153
DE.750.181	98	DE.917.110	77	DI.220.010	156	DI.706.050	154	DI.811.040	153
DE.750.190	98	DE.917.120	77	DI.220.020	156	DI.706.060	154	DI.811.050	153
DE.750.210	98	DE.917.130	77	DI.220.030	156	DI.711.010	155	DI.820.010	156
DE.750.220	98	DE.917.140	77	DI.230.010	156	DI.711.020	155	DI.820.020	156
DE.750.230	98	DE.917.150	77	DI.230.020	156	DI.711.030	155	DI.820.030	156
DE.750.240	98	DE.917.160	77	DI.230.030	156	DI.711.040	155	DI.820.040	156
DE.750.290	98	DE.917.170	77	DI.250.000	156	DI.711.050	155	DI.820.050	156
DE.750.295	98	DE.920.000	79	DI.260.000	156	DI.711.060	155	DI.821.010	153
DE.750.330	99	DE.920.010	79	DI.300.010	157	DI.716.010	155	DI.821.020	153
DE.750.331	99	DE.920.015	79	DI.300.020	157	DI.716.020	155	DI.821.030	153
DE.750.335	99	DE.920.020	79	DI.300.030	157	DI.716.030	155	DI.821.040	153
DE.750.450	99	DE.920.025	79	DI.300.040	157	DI.716.040	155	DI.821.050	153
DE.750.463	99	DE.920.030	79	DI.310.010	157	DI.716.050	155	DI.830.010	156
DE.750.510	99	DE.920.035	79	DI.310.020	157	DI.716.060	155	DI.830.020	156
DE.750.511	99	DE.920.040	79	DI.310.030	157	DI.721.000	154	DI.830.030	156
DE.750.515	99	DE.920.045	79	DI.310.040	157	DI.721.060	154	DI.830.040	156
DE.750.670	100	DE.920.050	79	DI.320.010	157	DI.721.080	154	DI.830.050	156
DE.750.671	100	DE.920.055	79	DI.320.020	157	DI.726.000	155	DI.831.010	153
DE.750.730	100	DE.920.060	79	DI.320.030	157	DI.726.060	155	DI.831.020	153
DE.750.740	100	DE.920.065	79	DI.320.040	157	DI.726.080	155	DI.831.030	153
DE.750.743	100	DE.920.070	79	DI.330.010	157	DI.751.010	154	DI.831.040	153
DE.750.750	100	DE.920.075	79	DI.330.020	157	DI.751.020	154	DI.831.050	153
DE.750.790	100	DE.925.010	80	DI.330.030	157	DI.751.030	154	DI.850.000	156
DE.750.861	100	DE.925.020	80	DI.330.040	157	DI.751.040	154	DI.850.060	156
DE.750.863	101	DE.925.030	80	DI.350.000	157	DI.751.050	154	DI.851.000	153
DE.750.870	101	DE.925.040	80	DI.360.000	157	DI.751.060	154	DI.851.060	153

Code Index

Indice Per Codice

Code/Codice	Page/Pagina	Code/Codice	Page/Pagina	Code/Codice	Page/Pagina	Code/Codice	Page/Pagina	Code/Codice	Page/Pagina
DI.860.000	156	DL.400.010	164	DL.825.051	166	DL.955.010	166	DO.520.300	182
DI.860.060	156	DL.400.020	164	DL.825.052	166	DL.955.020	166	DO.525.010	182
DI.861.000	153	DL.410.170	164	DL.825.053	166	DL.955.030	166	DO.525.300	182
DI.861.060	153	DL.415.200	164	DL.825.054	166	DO.120.010	175	DO.536.200	180
DI.899.010	158	DL.450.030	164	DL.825.055	166	DO.125.010	175	DO.542.200	180
DI.899.020	158	DL.450.040	164	DL.825.060	166	DO.130.010	176	DO.545.200	180
DI.899.030	158	DL.450.050	164	DL.825.061	166	DO.130.015	176	DO.550.100	180
DI.899.040	158	DL.450.060	164	DL.825.062	166	DO.151.000	174	DO.550.200	180
DI.899.050	158	DL.450.070	164	DL.825.063	166	DO.160.000	174	DO.555.100	180
DI.899.060	158	DL.450.080	164	DL.825.064	166	DO.170.000	174	DO.555.200	180
DI.900.300	158	DL.450.090	164	DL.825.065	166	DO.172.000	174	DO.565.200	181
DI.900.310	158	DL.460.010	164	DL.825.070	165	DO.175.000	174	DO.571.200	181
DI.900.320	158	DL.461.010	164	DL.825.080	165	DO.200.010	174	DO.574.200	181
DI.900.330	158	DL.461.020	164	DL.855.010	167	DO.204.000	174	DO.580.300	181
DI.900.990	158	DL.461.030	164	DL.864.010	168	DO.205.018	174	DO.585.300	186
DI.901.010	158	DL.461.040	164	DL.864.020	168	DO.205.022	174	DO.592.300	182
DI.901.020	158	DL.461.050	164	DL.864.030	168	DO.206.018	174	DO.600.300	184
DI.901.030	158	DL.461.060	164	DL.864.040	168	DO.206.022	174	DO.602.300	184
DI.901.040	158	DL.461.070	164	DL.864.050	168	DO.209.010	175	DO.610.300	182
DI.901.050	158	DL.500.011	164	DL.864.060	168	DO.210.135	175	DO.613.300	184
DI.901.060	158	DL.500.021	164	DL.864.070	168	DO.213.135	175	DO.618.300	186
DI.905.300	158	DL.500.031	164	DL.864.120	167	DO.214.135	175	DO.620.300	186
DI.905.310	158	DL.500.041	164	DL.864.130	167	DO.215.135	175	DO.621.300	186
DI.905.320	158	DL.501.017	164	DL.870.310	167	DO.217.135	175	DO.624.300	183
DI.905.330	158	DL.501.027	164	DL.875.010	169	DO.220.110	175	DO.641.300	186
DI.905.990	158	DL.501.037	164	DL.875.030	169	DO.227.120	175	DO.655.300	186
DI.999.000	155	DL.650.000	163	DL.875.050	169	DO.227.135	175	DO.661.300	184
DL.009.000	161	DL.650.010	163	DL.875.060	169	DO.228.125	175	DO.662.300	184
DL.010.000	161	DL.650.020	163	DL.880.010	169	DO.228.135	175	DO.664.300	184
DL.015.010	161	DL.655.000	163	DL.880.020	169	DO.235.010	176	DO.665.300	184
DL.015.020	161	DL.655.010	163	DL.880.030	169	DO.235.015	176	DO.675.300	185
DL.019.010	161	DL.655.020	163	DL.880.040	169	DO.240.010	176	DO.688.300	185
DL.019.020	161	DL.655.030	163	DL.880.070	169	DO.240.015	176	DO.700.010	185
DL.027.000	161	DL.700.310	163	DL.880.080	169	DO.240.020	176	DO.705.300	185
DL.041.000	160	DL.705.400	163	DL.882.010	169	DO.240.025	176	DO.710.200	185
DL.050.000	160	DL.715.560	163	DL.882.020	169	DO.240.035	176	DO.712.300	185
DL.050.001	160	DL.780.010	163	DL.882.030	169	DO.250.010	177	DO.713.300	185
DL.050.002	160	DL.780.020	163	DL.900.000	167	DO.250.015	177	DO.735.100	183
DL.050.003	160	DL.790.200	163	DL.900.010	167	DO.270.155	178	DO.735.300	183
DL.050.004	160	DL.790.300	163	DL.900.020	167	DO.270.160	178	DO.736.300	183
DL.060.000	161	DL.805.010	166	DL.900.030	167	DO.271.165	178	DO.738.100	183
DL.100.010	162	DL.805.020	166	DL.900.040	167	DO.272.165	178	DO.738.300	183
DL.100.020	162	DL.810.010	165	DL.900.050	167	DO.285.010	178	DO.739.300	183
DL.1000.00	161	DL.810.020	165	DL.905.000	167	DO.290.120	179	DO.750.010	187
DL.101.030	162	DL.810.030	165	DL.905.010	167	DO.291.120	179	DO.750.020	187
DL.101.040	162	DL.815.010	166	DL.905.020	167	DO.292.120	178	DO.750.030	187
DL.1010.00	161	DL.815.020	166	DL.905.030	167	DO.294.140	179	DO.750.040	187
DL.150.010	162	DL.815.030	165	DL.905.040	167	DO.295.140	178	DO.750.050	187
DL.150.020	162	DL.815.040	165	DL.905.050	167	DO.370.015	177	DO.750.060	187
DL.151.125	162	DL.815.050	166	DL.918.010	167	DO.370.025	177	DO.777.100	188
DL.151.150	162	DL.815.051	166	DL.932.010	167	DO.375.010	177	DO.779.100	188
DL.154.020	162	DL.815.052	166	DL.945.010	168	DO.376.010	177	DO.785.300	189
DL.255.010	163	DL.815.053	166	DL.945.020	168	DO.377.010	177	DO.786.300	189
DL.255.020	163	DL.815.054	166	DL.945.030	168	DO.377.015	177	DO.787.300	189
DL.325.200	163	DL.815.055	166	DL.945.040	168	DO.392.010	179	DO.795.300	190
DL.326.200	163	DL.815.060	166	DL.945.050	168	DO.392.020	179	DO.796.100	190
DL.330.010	165	DL.815.061	166	DL.945.060	168	DO.392.030	179	DO.796.300	190
DL.332.010	165	DL.815.062	166	DL.949.010	166	DO.393.030	179	DO.798.300	190
DL.335.160	165	DL.815.063	166	DL.949.011	166	DO.395.140	179	DO.799.100	190
DL.335.170	165	DL.815.064	166	DL.949.020	166	DO.396.140	179	DO.799.300	190
DL.337.160	165	DL.815.065	166	DL.949.021	166	DO.465.300	181	DO.806.300	191
DL.337.170	165	DL.815.070	165	DL.949.030	166	DO.475.300	181	DO.807.300	191
DL.340.180	165	DL.815.080	165	DL.949.031	166	DO.479.300	181	DO.808.300	191
DL.350.010	165	DL.825.010	166	DL.950.000	166	DO.492.300	181	DO.810.300	193
DL.350.030	165	DL.825.020	166	DL.950.010	166	DO.495.010	181	DO.812.300	192
DL.350.040	165	DL.825.030	165	DL.950.020	166	DO.495.020	181	DO.824.300	192
DL.350.050	165	DL.825.040	165	DL.950.030	166	DO.510.300	182	DO.835.300	192
DL.350.060	165	DL.825.050	166	DL.955.000	166	DO.511.300	182	DO.838.300	192

Code Index

Indice Per Codice

Code/Codice	Page/Pagina	Code/Codice	Page/Pagina	Code/Codice	Page/Pagina	Code/Codice	Page/Pagina	Code/Codice	Page/Pagina
DO.850.300	192	DP.365.060	24	DP.793.020	25	DR.026.030	47	DR.130.025	49
DO.860.300	193	DP.365.065	24	DP.793.025	25	DR.028.010	47	DR.130.030	49
DO.861.300	193	DP.375.075	24	DP.793.040	25	DR.040.014	32	DR.130.035	49
DO.870.300	191	DP.375.095	24	DP.793.045	25	DR.040.024	32	DR.130.040	49
DO.871.300	191	DP.469.160	110	DP.793.050	25	DR.041.004	32	DR.130.045	49
DO.872.300	191	DP.469.165	110	DP.793.055	25	DR.041.014	32	DR.130.050	49
DO.874.300	192	DP.480.020	110	DP.803.031	21	DR.045.004	32	DR.130.055	49
DO.876.300	193	DP.480.025	110	DP.803.051	21	DR.046.004	32	DR.135.551	41
DO.877.300	193	DP.500.013	110	DP.827.030	25	DR.047.004	32	DR.139.020	49
DO.884.300	188	DP.500.023	110	DP.827.035	25	DR.050.010	48	DR.139.021	41
DO.885.300	188	DP.550.000T	111	DP.835.080	25	DR.050.017	50	DR.139.030	49
DO.886.300	188	DP.550.015T	111	DP.835.085	25	DR.050.020	48	DR.139.031	41
DO.888.300	189	DP.550.025T	111	DP.895.045	26	DR.050.027	50	DR.148.020	49
DO.895.300	188	DP.550.035T	111	DP.895.047	26	DR.050.030	48	DR.148.040	49
DO.896.300	193	DP.550.045T	111	DP.895.055	26	DR.050.037	50	DR.148.041	41
DO.963.010	194	DP.550.055T	111	DP.895.057	26	DR.051.051	40	DR.148.045	49
DO.963.020	194	DP.550.065T	111	DP.895.065	26	DR.063.011	40	DR.148.060	49
DO.963.030	194	DP.635.155	113	DP.895.067	26	DR.063.017	48	DR.225.030	55
DO.963.040	194	DP.635.165	113	DP.895.075	26	DR.063.021	40	DR.230.030	55
DO.964.010	194	DP.637.145	113	DP.895.077	26	DR.063.027	48	DR.231.020	55
DO.964.030	194	DP.640.205	113	DP.900.015	26	DR.068.010	48	DR.235.010	55
DP.028.135	109	DP.643.015	113	DP.900.017	26	DR.068.020	48	DR.235.020	55
DP.040.365	109	DP.643.025	113	DP.900.025	26	DR.068.030	48	DR.248.751	45
DP.078.010	109	DP.658.035	113	DP.900.027	26	DR.069.010	48	DR.248.771	45
DP.078.020	109	DP.660.075	113	DP.900.035	26	DR.069.020	48	DR.270.010	55
DP.085.013	109	DP.660.085	113	DP.900.037	26	DR.069.030	48	DR.270.020	55
DP.085.023	109	DP.660.090	113	DP.930.015	26	DR.073.031	40	DR.274.080	55
DP.125.140	24	DP.660.095	113	DP.930.017	26	DR.081.010	48	DR.279.010	55
DP.125.145	24	DP.663.100	114	DP.930.025	26	DR.081.020	48	DR.279.020	55
DP.128.020	24	DP.665.034	112	DP.930.027	26	DR.081.030	48	DR.279.030	55
DP.128.025	24	DP.665.035	113	DP.930.035	26	DR.081.040	48	DR.279.040	55
DP.128.040	24	DP.666.094	112	DP.930.037	26	DR.081.050	48	DR.296.065	55
DP.128.045	24	DP.667.210	114	DP.930.045	26	DR.081.060	48	DR.297.025	55
DP.135.601	21	DP.667.230	114	DP.930.047	26	DR.089.010	48	DR.298.025	55
DP.156.000	21	DP.690.015	78	DP.930.067	26	DR.089.020	48	DR.3101.00	28
DP.156.021	20	DP.690.025	78	DP.930.075	26	DR.089.030	48	DR.3101.01	28
DP.156.041	20	DP.690.035	78	DP.930.077	26	DR.089.040	48	DR.3101.08	28
DP.156.061	20	DP.698.000	78	DP.930.335	26	DR.090.010	48	DR.3101.10	28
DP.156.081	20	DP.698.001	78	DP.930.337	26	DR.090.020	48	DR.3101.15	28
DP.156.101	20	DP.698.010	78	DP.930.345	26	DR.090.030	48	DR.3101.20	28
DP.156.111	20	DP.698.020	78	DP.930.347	26	DR.090.040	48	DR.3101.25	28
DP.156.141	20	DP.698.030	78	DP.931.335	26	DR.091.011	40	DR.3101.30	28
DP.160.020	23	DP.698.040	78	DP.931.345	26	DR.092.001	40	DR.3101.35	28
DP.160.021	20	DP.705.150	120	DP.940.155	26	DR.095.010	48	DR.3101.40	28
DP.160.025	22	DP.706.150	120	DP.940.157	26	DR.095.020	48	DR.3101.45	28
DP.160.040	23	DP.714.010	107	DP.980.000T	130	DR.098.010	47	DR.3101.50	28
DP.160.041	20	DP.714.020	107	DP.980.015T	130	DR.100.011	41	DR.3101.55	28
DP.160.045	22	DP.714.030	107	DP.980.025T	130	DR.100.017	50	DR.3101.60	28
DP.160.060	23	DP.763.010	25	DP.980.035T	130	DR.100.321	45	DR.3101.70	28
DP.160.061	20	DP.763.015	25	DP.980.045T	130	DR.100.731	45	DR.3101.80	28
DP.160.065	22	DP.763.020	25	DP.980.055T	130	DR.101.011	41	DR.3102.00	28
DP.160.080	23	DP.763.021	21	DP.999.011	21	DR.101.017	50	DR.3102.01	28
DP.160.081	20	DP.763.025	25	DP.999.015	23	DR.110.210	49	DR.3102.08	28
DP.160.085	22	DP.764.020	25	DP.999.020	22	DR.110.215	49	DR.3102.10	28
DP.160.100	23	DP.764.025	25	DR.001.010	47	DR.111.210	49	DR.3102.15	28
DP.160.101	20	DP.772.030	25	DR.001.020	47	DR.111.211	41	DR.3102.20	28
DP.160.105	22	DP.772.035	25	DR.001.030	47	DR.111.215	49	DR.3102.25	28
DP.160.110	23	DP.773.060	25	DR.001.040	47	DR.120.180	49	DR.3102.30	28
DP.160.111	20	DP.773.065	25	DR.006.010	47	DR.120.187	50	DR.3102.35	28
DP.160.115	22	DP.782.010	25	DR.006.020	47	DR.121.011	41	DR.3102.40	28
DP.160.140	23	DP.782.015	25	DR.006.030	47	DR.121.021	41	DR.3102.45	28
DP.160.141	20	DP.786.070	25	DR.006.040	47	DR.121.111	45	DR.3102.50	28
DP.160.145	22	DP.786.071	21	DR.022.101	47	DR.126.290	49	DR.3102.55	28
DP.345.105	109	DP.786.075	25	DR.023.010	47	DR.126.310	49	DR.3102.60	28
DP.347.025	109	DP.792.320	25	DR.024.020	47	DR.126.340	49	DR.3102.70	28
DP.347.045	109	DP.792.325	25	DR.024.030	47	DR.130.010	49	DR.3102.80	28
DP.365.050	24	DP.792.330	25	DR.026.010	47	DR.130.015	49	DR.3103.00	28
DP.365.055	24	DP.792.335	25	DR.026.020	47	DR.130.020	49	DR.3103.01	28

Code Index

Indice Per Codice

Code/Codice	Page/Pagina	Code/Codice	Page/Pagina	Code/Codice	Page/Pagina	Code/Codice	Page/Pagina	Code/Codice	Page/Pagina
DR.3103.08	28	DR.3121.30	29	DR.3141.35	29	DR.3161.20	28	DR.3172.60	29
DR.3103.10	28	DR.3121.35	29	DR.3141.40	29	DR.3161.25	28	DR.3172.70	29
DR.3103.15	28	DR.3121.40	29	DR.3141.45	29	DR.3161.30	28	DR.3172.80	29
DR.3103.20	28	DR.3121.45	29	DR.3142.00	29	DR.3161.35	28	DR.3173.00	29
DR.3103.25	28	DR.3121.50	29	DR.3142.15	29	DR.3161.40	28	DR.3173.01	29
DR.3103.30	28	DR.3121.55	29	DR.3142.20	29	DR.3161.45	28	DR.3173.10	29
DR.3103.35	28	DR.3121.60	29	DR.3142.25	29	DR.3161.50	28	DR.3173.15	29
DR.3103.40	28	DR.3121.70	29	DR.3142.30	29	DR.3161.55	28	DR.3173.20	29
DR.3103.45	28	DR.3121.80	29	DR.3142.35	29	DR.3161.60	28	DR.3173.25	29
DR.3103.50	28	DR.3122.00	29	DR.3142.40	29	DR.3161.70	28	DR.3173.30	29
DR.3103.55	28	DR.3122.01	29	DR.3142.45	29	DR.3161.80	28	DR.3173.35	29
DR.3103.60	28	DR.3122.10	29	DR.3143.00	29	DR.3162.00	28	DR.3173.40	29
DR.3103.70	28	DR.3122.15	29	DR.3143.15	29	DR.3162.01	28	DR.3173.45	29
DR.3103.80	28	DR.3122.20	29	DR.3143.20	29	DR.3162.10	28	DR.3173.50	29
DR.3111.00	28	DR.3122.25	29	DR.3143.25	29	DR.3162.15	28	DR.3173.55	29
DR.3111.01	28	DR.3122.30	29	DR.3143.30	29	DR.3162.20	28	DR.3173.60	29
DR.3111.08	28	DR.3122.35	29	DR.3143.35	29	DR.3162.25	28	DR.3173.70	29
DR.3111.10	28	DR.3122.40	29	DR.3143.40	29	DR.3162.30	28	DR.3173.80	29
DR.3111.15	28	DR.3122.45	29	DR.3143.45	29	DR.3162.35	28	DR.370.011	45
DR.3111.20	28	DR.3122.50	29	DR.3151.00	28	DR.3162.40	28	DR.370.021	45
DR.3111.25	28	DR.3122.55	29	DR.3151.01	28	DR.3162.45	28	DR.370.260	54
DR.3111.30	28	DR.3122.60	29	DR.3151.10	28	DR.3162.50	28	DR.370.270	54
DR.3111.35	28	DR.3122.70	29	DR.3151.15	28	DR.3162.55	28	DR.370.280	54
DR.3111.40	28	DR.3122.80	29	DR.3151.20	28	DR.3162.60	28	DR.370.290	54
DR.3111.45	28	DR.3123.00	29	DR.3151.25	28	DR.3162.70	28	DR.370.780	54
DR.3111.50	28	DR.3123.01	29	DR.3151.30	28	DR.3162.80	28	DR.370.800	54
DR.3111.55	28	DR.3123.10	29	DR.3151.35	28	DR.3163.00	28	DR.400.011	38
DR.3111.60	28	DR.3123.15	29	DR.3151.40	28	DR.3163.01	28	DR.400.021	38
DR.3111.70	28	DR.3123.20	29	DR.3151.45	28	DR.3163.10	28	DR.400.031	38
DR.3111.80	28	DR.3123.25	29	DR.3151.50	28	DR.3163.15	28	DR.400.041	38
DR.3112.00	28	DR.3123.30	29	DR.3151.55	28	DR.3163.20	28	DR.400.051	39
DR.3112.01	28	DR.3123.35	29	DR.3151.60	28	DR.3163.25	28	DR.400.061	39
DR.3112.08	28	DR.3123.40	29	DR.3151.70	28	DR.3163.30	28	DR.400.071	39
DR.3112.10	28	DR.3123.45	29	DR.3151.80	28	DR.3163.35	28	DR.400.081	39
DR.3112.15	28	DR.3123.50	29	DR.3152.00	28	DR.3163.40	28	DR.425.011	44
DR.3112.20	28	DR.3123.55	29	DR.3152.01	28	DR.3163.45	28	DR.425.017	52
DR.3112.25	28	DR.3123.60	29	DR.3152.10	28	DR.3163.50	28	DR.425.060	51
DR.3112.30	28	DR.3123.70	29	DR.3152.15	28	DR.3163.55	28	DR.425.061	44
DR.3112.35	28	DR.3123.80	29	DR.3152.20	28	DR.3163.60	28	DR.425.067	52
DR.3112.40	28	DR.3131.00	29	DR.3152.25	28	DR.3163.70	28	DR.425.471	45
DR.3112.45	28	DR.3131.15	29	DR.3152.30	28	DR.3163.80	28	DR.426.561	42
DR.3112.50	28	DR.3131.20	29	DR.3152.35	28	DR.3171.00	29	DR.426.567	52
DR.3112.55	28	DR.3131.25	29	DR.3152.40	28	DR.3171.01	29	DR.426.780	51
DR.3112.60	28	DR.3131.30	29	DR.3152.45	28	DR.3171.10	29	DR.426.781	44
DR.3112.70	28	DR.3131.35	29	DR.3152.50	28	DR.3171.15	29	DR.426.787	52
DR.3112.80	28	DR.3131.40	29	DR.3152.55	28	DR.3171.20	29	DR.431.081	42
DR.3113.00	28	DR.3131.45	29	DR.3152.60	28	DR.3171.25	29	DR.432.070	51
DR.3113.01	28	DR.3132.00	29	DR.3152.70	28	DR.3171.30	29	DR.440.491	44
DR.3113.08	28	DR.3132.15	29	DR.3152.80	28	DR.3171.35	29	DR.440.497	52
DR.3113.10	28	DR.3132.20	29	DR.3153.00	28	DR.3171.40	29	DR.440.790	51
DR.3113.15	28	DR.3132.25	29	DR.3153.01	28	DR.3171.45	29	DR.440.791	44
DR.3113.20	28	DR.3132.30	29	DR.3153.10	28	DR.3171.50	29	DR.440.797	52
DR.3113.25	28	DR.3132.35	29	DR.3153.15	28	DR.3171.55	29	DR.445.011	42
DR.3113.30	28	DR.3132.40	29	DR.3153.20	28	DR.3171.60	29	DR.445.021	42
DR.3113.35	28	DR.3132.45	29	DR.3153.25	28	DR.3171.70	29	DR.451.011	42
DR.3113.40	28	DR.3133.00	29	DR.3153.30	28	DR.3171.80	29	DR.451.021	42
DR.3113.45	28	DR.3133.15	29	DR.3153.35	28	DR.3172.00	29	DR.452.000	51
DR.3113.50	28	DR.3133.20	29	DR.3153.40	28	DR.3172.01	29	DR.452.005	52
DR.3113.55	28	DR.3133.25	29	DR.3153.45	28	DR.3172.10	29	DR.452.010	51
DR.3113.60	28	DR.3133.30	29	DR.3153.50	28	DR.3172.15	29	DR.452.015	52
DR.3113.70	28	DR.3133.35	29	DR.3153.55	28	DR.3172.20	29	DR.452.020	51
DR.3113.80	28	DR.3133.40	29	DR.3153.60	28	DR.3172.25	29	DR.452.025	52
DR.3121.00	29	DR.3133.45	29	DR.3153.70	28	DR.3172.30	29	DR.452.030	51
DR.3121.01	29	DR.3141.00	29	DR.3153.80	28	DR.3172.35	29	DR.452.035	52
DR.3121.10	29	DR.3141.15	29	DR.3161.00	28	DR.3172.40	29	DR.452.040	51
DR.3121.15	29	DR.3141.20	29	DR.3161.01	28	DR.3172.45	29	DR.452.045	52
DR.3121.20	29	DR.3141.25	29	DR.3161.10	28	DR.3172.50	29	DR.452.050	51
DR.3121.25	29	DR.3141.30	29	DR.3161.15	28	DR.3172.55	29	DR.452.055	52

Code Index

Indice Per Codice

Code/Codice	Page/Pagina	Code/Codice	Page/Pagina	Code/Codice	Page/Pagina	Code/Codice	Page/Pagina	Code/Codice	Page/Pagina
DR.452.060	51	DR.571.000	57	DR.623.020	54	DR.906.110	61	DS.100.044	115
DR.452.065	52	DR.571.010	57	DR.623.030	54	DR.906.120	61	DS.100.045	116
DR.452.070	51	DR.571.020	57	DR.623.040	54	DR.906.130	61	DS.105.010	117
DR.452.075	52	DR.571.030	57	DR.698.010	57	DR.906.140	61	DS.105.020	117
DR.452.080	51	DR.577.310	30	DR.699.010	57	DR.906.150	61	DS.105.030	117
DR.452.085	52	DR.577.320	30	DR.700.010	57	DR.906.180	61	DS.106.010	117
DR.452.090	51	DR.577.330	30	DR.700.020	57	DR.906.210	61	DS.106.020	117
DR.452.095	52	DR.582.010	30	DR.799.050	58	DR.906.211	61	DS.106.030	117
DR.452.100	51	DR.582.014	30	DR.799.060	58	DR.906.212	61	DS.107.010	117
DR.452.105	52	DR.582.020	30	DR.799.070	58	DR.906.370	61	DS.107.020	117
DR.452.110	51	DR.582.024	30	DR.800.050	58	DR.906.500	61	DS.107.030	117
DR.452.115	52	DR.584.014	30	DR.800.060	58	DR.906.510	61	DS.110.850	116
DR.452.120	51	DR.584.161	30	DR.800.070	58	DR.906.530	61	DS.110.855	116
DR.452.125	52	DR.584.164	30	DR.809.010	58	DR.906.550	61	DS.110.860	116
DR.457.011	42	DR.584.171	30	DR.809.020	58	DR.906.560	61	DS.110.865	116
DR.457.021	42	DR.584.231	30	DR.820.170	58	DR.906.570	61	DS.110.870	116
DR.457.031	43	DR.584.281	30	DR.829.050	58	DR.906.580	61	DS.110.875	116
DR.457.041	43	DR.586.020	34	DR.830.085	58	DR.906.590	61	DS.110.880	116
DR.458.011	43	DR.587.030	34	DR.830.086	58	DR.906.600	61	DS.110.885	116
DR.458.031	43	DR.587.040	34	DR.830.087	58	DR.906.620	61	DS.112.845	115
DR.458.041	43	DR.587.050	34	DR.830.089	58	DR.906.660	61	DS.112.855	115
DR.459.011	43	DR.587.060	34	DR.830.120	58	DR.926.170	63	DS.112.865	115
DR.460.050	51	DR.587.130	34	DR.830.121	58	DR.928.170	63	DS.112.875	115
DR.460.051	43	DR.590.014	31	DR.832.010	58	DR.929.170	63	DS.112.885	115
DR.463.000	51	DR.590.024	31	DR.832.020	58	DR.931.170	63	DS.125.010	117
DR.463.001	43	DR.591.421	31	DR.835.010	58	DR.932.170	63	DS.125.020	117
DR.463.005	52	DR.594.013	31	DR.835.020	58	DR.937.000	62	DS.125.040	117
DR.463.007	52	DR.594.014	31	DR.840.010	58	DR.937.010	62	DS.125.050	117
DR.463.010	51	DR.594.023	31	DR.840.020	58	DR.937.020	62	DS.125.060	117
DR.463.011	44	DR.594.024	31	DR.840.030	58	DR.937.030	62	DS.126.044	34
DR.463.015	52	DR.594.033	31	DR.855.010	58	DR.937.040	62	DS.146.014	34
DR.463.017	52	DR.594.034	31	DR.865.014	33	DR.937.050	62	DS.146.024	34
DR.463.020	51	DR.594.043	31	DR.866.014	33	DR.937.060	62	DS.147.014	34
DR.463.021	44	DR.594.044	31	DR.866.024	33	DR.938.110	62	DS.147.024	34
DR.463.025	52	DR.596.011	31	DR.867.000	50	DR.938.130	62	DS.198.040	114
DR.463.027	52	DR.596.021	31	DR.868.000	50	DR.938.150	62	DS.198.050	114
DR.513.031	44	DR.596.031	31	DR.870.011	45	DR.940.160	63	DS.200.100	118
DR.518.010	51	DR.596.041	31	DR.872.001	50	DR.946.160	63	DS.200.121	118
DR.518.020	51	DR.602.013	32	DR.872.005	50	DR.948.000	63	DS.200.330	118
DR.518.030	51	DR.602.014	32	DR.873.017	50	DR.959.008	53	DS.210.120	118
DR.531.160	57	DR.602.023	32	DR.879.014	33	DR.960.008	53	DS.220.450	118
DR.532.160	57	DR.602.024	32	DR.879.024	33	DR.960.011	53	DS.220.640	118
DR.535.000	57	DR.602.033	32	DR.900.000	64	DR.960.018	53	DS.221.010	118
DR.535.010	57	DR.602.034	32	DR.900.001	65	DR.960.021	53	DS.221.020	118
DR.539.010	57	DR.602.043	32	DR.900.002	66	DR.960.028	53	DS.221.030	118
DR.549.000	56	DR.602.044	32	DR.904.010	59	DR.960.031	53	DS.270.190	120
DR.549.001	56	DR.602.053	32	DR.904.020	59	DR.960.038	53	DS.273.010	124
DR.549.002	56	DR.602.063	32	DR.904.030	59	DR.960.048	53	DS.273.020	124
DR.549.003	56	DR.602.073	32	DR.905.001	60	DR.974.038	53	DS.273.160	124
DR.549.004	56	DR.608.011	46	DR.905.002	60	DR.980.027	53	DS.273.190	124
DR.549.010	56	DR.608.021	46	DR.905.003	60	DR.996.005	53	DS.350.017	114
DR.554.000	56	DR.608.111	46	DR.905.004	60	DR.998.010	53	DS.350.027	114
DR.554.001	56	DR.608.121	46	DR.905.005	60	DR.998.020	53	DS.375.020	106
DR.554.002	56	DR.608.131	46	DR.905.006	60	DR.998.030	53	DS.375.100	106
DR.554.003	56	DR.608.211	46	DR.905.007	60	DS.055.010	120	DS.380.010	106
DR.554.010	56	DR.608.221	46	DR.905.008	60	DS.055.020	120	DS.380.020	107
DR.555.000	56	DR.608.231	46	DR.905.009	60	DS.070.010	120	DS.389.145	107
DR.555.001	56	DR.608.241	46	DR.905.010	60	DS.070.020	120	DS.405.000	107
DR.555.002	56	DR.609.060	54	DR.905.011	60	DS.100.010	116	DS.405.010	107
DR.555.010	56	DR.609.140	54	DR.905.012	60	DS.100.014	115	DS.416.010	106
DR.556.000	56	DR.609.170	54	DR.905.013	60	DS.100.015	116	DS.416.011	106
DR.559.000	56	DR.609.180	54	DR.905.014	60	DS.100.020	116	DS.416.012	106
DR.559.001	56	DR.609.190	54	DR.905.015	60	DS.100.024	115	DS.416.013	106
DR.559.002	56	DR.610.170	54	DR.905.016	60	DS.100.025	116	DS.416.020	106
DR.559.003	56	DR.610.180	54	DR.905.017	60	DS.100.030	116	DS.416.030	106
DR.559.010	56	DR.610.190	54	DR.906.020	61	DS.100.034	115	DS.416.040	106
DR.560.000	56	DR.623.000	54	DR.906.090	61	DS.100.035	116	DS.427.010	107
DR.570.000	57	DR.623.010	54	DR.906.100	61	DS.100.040	116	DS.427.020	107

Code Index

Indice Per Codice

Code/Codice	Page/Pagina	Code/Codice	Page/Pagina	Code/Codice	Page/Pagina	Code/Codice	Page/Pagina	Code/Codice	Page/Pagina
DS.427.030	107	DS.830.091	112	DS.929.010	122	DZ.086.039	196	DZ.435.010	197
DS.434.010	16	DS.832.011	112	DS.931.022	125	DZ.092.050	196	DZ.435.020	197
DS.434.020	16	DS.832.015	112	DS.931.028	125	DZ.092.070	196	DZ.465.000	199
DS.435.000	17	DS.832.025	112	DS.931.035	125	DZ.092.080	196	DZ.467.000	199
DS.435.000B	17	DS.832.035	112	DS.931.042	125	DZ.092.100	196	DZ.470.000	199
DS.435.010	17	DS.838.015	112	DS.931.048	125	DZ.094.000	012, 196	DZ.525.010	202
DS.435.010B	17	DS.839.031	112	DS.936.022	125	DZ.095.000	196	DZ.525.020	202
DS.435.020	17	DS.845.015	112	DS.936.028	125	DZ.095.010	196	DZ.525.030	202
DS.435.020B	17	DS.845.025	112	DS.936.035	125	DZ.095.020	196	DZ.525.040	202
DS.435.030	17	DS.848.020	107	DS.936.042	125	DZ.200.010	200	DZ.525.050	202
DS.435.030B	17	DS.848.040	107	DS.936.048	125	DZ.200.020	200	DZ.530.010	202
DS.437.010	17	DS.848.050	107	DZ.050.010	201	DZ.201.010	200	DZ.532.000	202
DS.437.010B	17	DS.848.060	107	DZ.051.010	201	DZ.400.010	197	DZ.535.010	202
DS.488.014	33	DS.848.070	107	DZ.052.010	201	DZ.400.020	197	DZ.535.020	202
DS.488.024	33	DS.849.010	123	DZ.055.010	201	DZ.400.030	197	DZ.535.030	202
DS.488.034	33	DS.849.011	123	DZ.060.010	201	DZ.400.040	197	DZ.535.040	202
DS.503.100	120	DS.849.020	123	DZ.060.020	201	DZ.400.050	197	DZ.535.050	202
DS.508.140	120	DS.849.021	123	DZ.061.010	201	DZ.401.010	197	DZ.540.010	202
DS.524.120	139	DS.849.030	123	DZ.061.020	201	DZ.401.020	197	DZ.540.020	202
DS.525.120	139	DS.849.031	123	DZ.061.030	201	DZ.401.030	197	DZ.544.010	202
DS.526.120	139	DS.851.010	123	DZ.064.010	201	DZ.401.040	197	DZ.555.000	36
DS.527.120	139	DS.851.040	123	DZ.064.015	201	DZ.401.050	197	DZ.556.000	36
DS.530.120	138	DS.851.050	123	DZ.064.020	201	DZ.402.010	197	DZ.565.010	36
DS.531.120	138	DS.851.060	123	DZ.064.025	201	DZ.402.020	197	DZ.565.020	36
DS.533.120	138	DS.853.010	123	DZ.064.030	201	DZ.405.010	197	DZ.565.030	36
DS.536.010	139	DS.855.011	123	DZ.064.035	201	DZ.405.020	197	DZ.565.040	36
DS.536.011	138	DS.855.021	123	DZ.064.040	201	DZ.405.030	197	DZ.565.050	36
DS.537.010	139	DS.855.031	123	DZ.064.045	201	DZ.405.040	197	DZ.572.010	35
DS.537.011	138	DS.855.041	123	DZ.064.050	201	DZ.405.050	197	DZ.572.050	35
DS.539.010	139	DS.863.015	128	DZ.064.055	201	DZ.406.010	197	DZ.572.100	35
DS.539.011	138	DS.864.015	128	DZ.064.060	201	DZ.406.020	197	DZ.573.000	35
DS.540.160	138	DS.865.015	128	DZ.064.065	201	DZ.406.030	197	DZ.573.010	35
DS.541.160	138	DS.865.025	128	DZ.080.000	196	DZ.406.040	197	DZ.573.020	35
DS.560.120	138	DS.866.010	122	DZ.080.010	196	DZ.406.050	197	DZ.574.010	35
DS.561.120	138	DS.866.020	122	DZ.080.020	196	DZ.407.010	197	DZ.575.010	35
DS.570.130	138	DS.867.015	129	DZ.080.030	196	DZ.407.020	197	DZ.8505.01	200
DS.571.130	138	DS.868.010	129	DZ.080.050	196	DZ.408.010	197	DZ.8505.02	200
DS.596.120	137	DS.872.015	127	DZ.080.080	196	DZ.408.020	197	DZ.8505.03	200
DS.597.120	137	DS.872.025	127	DZ.080.090	196	DZ.410.010	198	DZ.8505.04	200
DS.600.130	137	DS.872.035	127	DZ.080.110	196	DZ.410.020	198	DZ.8510.00	200
DS.601.130	137	DS.872.045	127	DZ.080.130	196	DZ.410.030	198	DZ.945.020	203
DS.650.160	120	DS.872.055	127	DZ.080.150	196	DZ.410.040	198	DZ.945.050	203
DS.800.010	122	DS.872.065	127	DZ.080.170	196	DZ.410.050	198	DZ.970.010	203
DS.801.011	129	DS.872.075	127	DZ.080.180	196	DZ.411.020	198	DZ.972.100	203
DS.801.201	129	DS.872.085	127	DZ.081.000	196	DZ.415.010	198	DZ.972.140	203
DS.801.601	129	DS.873.015	127	DZ.081.010	196	DZ.415.020	198	DZ.9950.00	200
DS.801.701	129	DS.873.025	127	DZ.081.020	196	DZ.415.030	198	FB.035.010	108
DS.801.999	129	DS.873.035	127	DZ.081.030	196	DZ.415.040	198	FB.035.020	108
DS.803.010	122	DS.873.045	127	DZ.081.050	196	DZ.420.010	199	FB.035.030	108
DS.804.010	122	DS.873.055	127	DZ.081.080	196	DZ.420.020	199	FB.060.130	108
DS.804.020	122	DS.873.065	127	DZ.081.090	196	DZ.420.030	199	FB.065.100	108
DS.804.030	122	DS.873.075	127	DZ.081.110	196	DZ.420.031	199	FB.065.110	108
DS.804.040	122	DS.873.085	127	DZ.081.130	196	DZ.420.040	199	FB.065.140	108
DS.804.050	122	DS.874.005T	128	DZ.081.150	196	DZ.420.050	199	FB.085.160	108
DS.805.000	122	DS.874.015T	128	DZ.081.170	196	DZ.425.010	198	FB.085.190	108
DS.813.031	124	DS.874.025T	128	DZ.081.180	196	DZ.425.020	198	FB.255.145	108
DS.813.041	124	DS.874.035T	128	DZ.085.090	16	DZ.425.030	198	FB.256.180	108
DS.813.061	124	DS.874.045T	128	DZ.086.010	196	DZ.425.040	198	FB.260.190	108
DS.813.081	124	DS.901.022	126	DZ.086.013	196	DZ.430.000	198	FB.298.010	108
DS.814.031	124	DS.901.028	126	DZ.086.015	196	DZ.430.010	198	FB.298.020	108
DS.814.041	124	DS.901.035	126	DZ.086.019	196	DZ.430.020	198	FB.310.200	107
DS.814.061	124	DS.901.042	126	DZ.086.020	196	DZ.430.030	198	FB.330.150	106
DS.814.081	124	DS.901.048	126	DZ.086.023	196	DZ.430.040	198	FB.430.010	107
DS.825.040	124	DS.911.022	126	DZ.086.025	196	DZ.430.070	197	FB.430.020	107
DS.825.075	124	DS.911.028	126	DZ.086.029	196	DZ.430.071	197	FB.430.030	107
DS.826.040	124	DS.911.035	126	DZ.086.030	196	DZ.430.080	197	FC.280.050	114
DS.826.075	124	DS.911.042	126	DZ.086.033	196	DZ.431.000	198	FC.420.010	120
DS.828.250	114	DS.911.048	126	DZ.086.035	196	DZ.432.000	198	FC.420.185	120

Code Index

Indice Per Codice

Code/Codice	Page/Pagina
FC.435.010	120
FC.435.190	120
FC.730.055	114
FC.826.100	106
FC.833.155	106
FC.920.180	106
FC.927.180	106
OC.450.030	120
OC.450.040	120
OC.450.050	120
OC.450.060	120
OC.640.000	117
OC.640.010	117
OC.640.020	117
OC.850.145	120
OG.450.030	120
OG.450.040	120
OG.450.050	120
OG.450.060	120
OR.720.010	119
OR.720.020	119
OR.720.030	119
OR.740.125	119
OR.741.140	119
OR.742.010	119
OR.742.020	119
OR.742.030	119
OR.742.040	119
OR.770.150	119
OR.775.165	119
OR.820.180	119
SDV69	175
SH.056.100	199
SH.056.125	199
SH.062.125	199
SH.062.150	199
SH.152.075	199
SH.155.120	199
SH.220.150	199
SH.227.200	199
SH.234.250	199
SH.242.350	199
SH.570.150	199
SH.570.180	199
SH.570.200	199
SH.570.250	199
SH.600.020	199
SH.600.040	199
SH.600.060	199
SH.600.090	199
SH.606.090	199
SH.606.100	199
SH.606.125	199
SH.606.150	199
SH.606.200	199
SH.720.100	202
SH.755.110	200
SH.755.150	200
SS.907.270	200
SS.920.200	200
SS.920.300	200
ZP.100.010	204
ZP.100.020	204
ZP.135.010	203
ZP.135.020	203
ZP.135.030	203
ZP.135.040	203

A	Page
Acorn/Wescott Burnishers	41,49
Adams Pliers Wire Bending	190
Aderer Pliers Loop Forming /Bending	193
Aderer Pliers Wire Bending	191
Adhesive Removers	176
Adson Forceps Dissecting	141
Adson Forceps Tissue	141,142
Adson-Brown Forceps Tissue	142
Adson-Fraser Forceps Haemostatic	144
Adson-Micro Forceps Dissecting	141
Adson-Micro Forceps Tissue	141,142
Ainsworth Punches Rubber Dam	63
Albrecht Tweezers Extraction	104
Alcohol Burners	161
Alginate Bowls	164
Alginate Spatulae	164
Allen Elevators Implant Periosteal	112
Alm Retractors Self-Retaining	150
Amalgam Carriers	47
Amalgam Carriers Micro	47
Amalgam Pluggers	40,48
Amalgam Well	47
Anaesthesia Syringes	67-74
Angle Pliers Wire Bending	182,192
Apical Elevators	87
Applicator For Medicaments	50
Applicators Bone Grafting Material	128
Applicators Elastomeric Ligature	177
Applicators For Calcium Hydroxide	50
Articulating Paper Forceps	57
Articulators	160,161
Atraumatic Extraction	75-82
Atraumatic Extraction Forceps	81,82
Atraumatic Forceps	141
Austin Retractors Cheek	106
Austin-Kay Retractors Cheek	106
B	
Baby-Crilewood Needle Holders	146
Backhaus Forceps Towel	143
Band Pushers	175,176
Band Seaters	175
Bandage Scissors	140
Bands Matrix	58
Baumgartner Needle Holders	146,147
Beale Carvers Modeling	167
Beavertail Burnishers	49
Bee Bee Scissors Crown	162
Beerendonk Vernier Caliper	174
Bein Elevators	85,87,89,91
Benders Distal Wires	176
Bernhard Elevators	86
Bernklau Rulers	174
Beyer Rongeurs Bone	119
Bib Holders/Chains	203
Bishop Retractors Cheek	106,107
Bite Gauge	152
Bite Sticks	175
Black Amalgam Pluggers	40,48
Blacks Margin Trimmers	54
Blade Removing Forceps	136
Blades For Laboratory Saw	163
Blades Scalpel	136
Blumenthal Rongeurs Bone	119
Boghosian Filling Instruments	42
Bohm Pliers Crown	162
Boley Gauges	162
Bone Block Clamps	122

B	Page
Bone Chisels	120
Bone Curettes	115-117
Bone Cutters	120
Bone Files	118
Bone Gouges	120
Bone Graft Compactors	128
Bone Grafting Applicators	128
Bone Injectors	123
Bone Mill	123
Bone Rongeurs	119
Bone Scrapers	123
Bone Thickness Gauges	122
Bone Well	123
Bone Well	123
Boone Gauges Bracket Positioning	174
Bottles Glass For medicines	200
Bow Divider Orthodontic	174
Bowdler-Henry Retractor	106
Bowls Alginate	164
Bowls Plaster	164
Bowls Stainless Steel	199
Boxes Endodontic	36
Boxes Stainless Steel	199
Boynton Needle Holders	148
Bracket Placing Tweezers	175
Bracket Positioning Gauges	174
Brass Series Siringhe	71-73
Brewer Forceps Rubber Dam Clamps	63
Bruenings Depressors Tongue	108
Buccal Tube Placing Tweezers	175
Bur Stands	201
Burners Alcohol	161
Burnishers	41,49,50
Burs Disinfecting Boxes	201
Burs Holders and Stands	201
Burs Tungsten Carbide HP	170-172
Busar Elevators Periosteal	112
Buttons Silicone For Impression Trays	155
C	
Calipers	162
Calipers Laboratory	162
Carvers Amalgam	45,55
Carvers For Silicone Impression Material	152
Carvers Laboratory	167,169
Cassette Trays	12,196
Castroviejo Bone Thickness Gauges	122
Castroviejo Needle Holders	145,147
Cattoni Probes Periodontal	8
Cavity Preparation Instruments	45,54
Cawood-Minnesota Müller Retractors Cheek	106
Cawood-Minnesota Retractors Cheek	106
Cement Spatulae	53
Ceramic Sculpturing Instruments	166
Cheatle Forceps Sterilizing	200
Cheek and Lip Retractors	16,17
Chisels Bone	120
Chisels Periodontal	109
Chompret Sindesmotomi	80
Clamp Matrix Strip	58
Clamps Bone Block	122
Cleoid-Discoïd	55
Cleveland Cutters Bone	120
Coleman Elevators	90
College Tweezers	10
College-TOE Tweezers	10
Collin Forceps Sterilizing	200
Color Code Rings	196

C	Page
Columbia Curettes	24
Columbia Retractors Cheek	107
Compactors Bone Graft	128
Compo-Art Instruments	38,39
Compo-Fill Instruments	40-44
Condensing Osteotomes	125
Contrastors	18
Cotton Holders and Dispensers	202
Coupland Elevators	86,87
Crane-Kaplan Scalars	25
Crile Forceps Haemostatic	144
Crile-Rankin Forceps Haemostatic	144
Crilewood Needle Holders	145,147
Crown Forceps	162
Crown Instruments	56,57
Crown Pliers	57,162
Crown Removers	56
Crown Scissors	162
Crown Spreaders	57
Cryer Elevators	86,87,90
Curettes Bone	115-117
Curettes Endodontics	34
Curettes Periodontal	20-24
Curettes Sinus Lift	127,128
Cutters Bone	120
Cutters Distal End	180
Cutters Ligature	181
Cutters Plaster	163
Cutters Wire	180,188,189
D	
Dappen Pots Glass	200
Darby Pery Scalars	26
De Bakke Forceps Atraumatic	141
De La Rosa Pliers Arch Contouring	184
Dental Surgery	105-120
Depressors Tongue	108
Derf Needle Holders	145,147
Diagnostic Instruments	1-12
Disc-System Syringes Self Aspirating	69,71
Disinfecting Boxes For Burs	201
Dispensers Cotton	202
Dispensers Drinking Cup	200
Dissecting Forceps	141,142
Distal end bending instruments	176
Distal End Cutters	180
Dolphin Pliers Universal	188
Dressing Forceps	143
E	
Easy-Color Filling Instruments	38-46
Easy-Color Implantology Instruments	129
Easy-Color Mouth Mirror Handles	3,4
Easy-Color Periodontal Instruments	20,21
Ehrlicke Pattern Impression Trays	156,157
Elastomeric Ligature Applicators / Removers	177
Elevators	85-93
Elevators Periosteal	112-114
Elevators Root Tips	93
Elevators Sinus Lift	127,128
Endodontic Boxes	36
Endodontic Cleaner	35
Endodontic Curettes	34
Endodontic Excavators	30
Endodontic Explorers	30
Endodontic Forceps	34
Endodontic Instruments	27-36
Endodontic Instruments Holder	35

Descriptive Index

E	Page	F	Page	G	Page
Endodontic Micro Applicators	33	Falcon Spatulae Alginate	164	German Model Amalgam Carriers	47
Endodontic Micro Pluggers/Burnishers	32	Falcon Spatulae Plaster	32	Gillies Hooks Skin	149
Endodontic Pluggers	29	Falcon Spreaders Endodontics	175	Gillies Needle Holders	148
Endodontic Reamers	29	Falcon Tweezers Buccal Tube Placing	174	Gingival Cord Packers	152
Endodontic Retractors	33	Falcon Vernier Caliper	180,181,188	Gingival Margin Trimmers	45,54
Endodontic Spreaders	29	Falcon-Cut Pliers	137	Gingivectomy Knives	110
Endodontic Trays	36	Falcon-Cut Scissors	141	Glass Mixing Slabs	53
Endodontic Tweezers	34	Falcon-Grip Forceps Dissecting	141	Goldman-Fox Cutters Bone	120
Endometers	35	Falcon-Grip Forceps Tissue	145,146	Goldman-Fox Elevators Periosteal	113
English Model Amalgam Carriers	47	Falcon-Grip Needle Holders	134	Goldman-Fox Hoes	24
Ermert Knives Wax	165	Falcon-Grip Needle Holders Micro	183,190	Goldman-Fox Probes Periodontal	8,9
Euro Syringes Manual Aspirating	70,73	Falcon-Grip Pliers	68	Goldman-Fox Scalars	25
Examination Sets	11,12	Falcon-ject Ultima Syringes Intraligamental	107	Goldman-Fox Scissors	137-139
Excavators	46,54	Falcon-Sternberg Retractors Cheek	149	Goldman-Fox Tweezers Pocket Marking	120
Excavators Endodontic	30	Farabeuf Retractors	54	Goldstein Filling Instruments	42,43
Explorers	5-7	Ferrier Margin Trimmers	118	Gouges Bone	120
Explorers Endodontics	30	Files Bone	28	Gracey Curettes	20-23
Expros	8	Files Endodontics	109	Gregg Filling Instruments	42,51
Extraction Forceps	94-104	Files Periodontal	40-53	Gritman Knives Plaster	165
Extraction Forceps Children Pattern	94-96	Filling Instruments	39	Gritman Spatulae Modeling	167
Extraction Forceps European Pattern	97-101	Filling Removers	55	Gross-Maier Forceps Dressing	143
Extraction Forceps With Anatomical Handle	102-103	Finishing Knives	152		
Extraction Instruments	83-104	Fischer Gingival Cord Packers	192	H	
Extraction Instruments Sets	84	Fisher Pliers Loop Forming /Bending	10	Haemostatic Forceps	144
Extraction Tweezers	104	Flagg Tweezers	86,88,91	Halsey Needle Holders	145
		Flohr Elevators	141	Halsted Mosquito Forceps Haemostatic	144,179
F		Forceps Atraumatic	162	Handles For Micro Scalpel Blades	132
Fahnenstock Knives Wax	165,166	Forceps Crown	141,142	Handles For Mouth Mirrors	3,4
Falcon Articulators	160	Forceps Dissecting	133	Handles For Photographic Mirrors	16
Falcon Bite Gauge	152	Forceps Dissecting Micro	143	Handles For Scalpel Blades	110,136
Falcon Bone Thickness Gauges	122	Forceps Dressing	34	Hartmann Forceps Haemostatic	144
Falcon Burnishers	49	Forceps Endodontics	94-104	Hedstrom Files	28
Falcon Carvers Modeling	167,168	Forceps Extraction	81,82	Heidebrink Elevators	86,93
Falcon Crown Removers	56	Forceps Extraction Atraumatic	57	Heidemann Filling Instruments	43,44,51,52
Falcon Crown Spreader	57	Forceps For Articulating Paper	136	Heister Mouth Gags	108
Falcon Curettes Sinus Lift	127	Forceps For Blade Removing	144	Hemingway Curettes Bone	115,116
Falcon Cutters Bone	120	Forceps Haemostatic	58	Henahan Retractor	107
Falcon Distal End Bending Pliers (Hammer head)	183	Forceps Matrix	63	Hilger Retractors Cheek	107
Falcon Elevators	85	Forceps Rubber Dam Clamps	34,143	Hirschfield Elevators Periosteal	113
Falcon Elevators Sinus Lift	127	Forceps Splinter	143	Hoes	24
Falcon Excavators	54	Forceps Sponge	200	Holders Burs	201
Falcon Excavators Endodontics	30	Forceps Sterilizing	120	Hollenback Amalgam Pluggers	40
Falcon Filling Instruments	42,51,52	Forceps Suture	141,142	Hollenback Carvers	55
Falcon Forceps For Articulating Paper	57	Forceps Tissue	133	Hollow Chop Pliers Arch Forming Falcon	184
Falcon Forceps Matrix	58	Forceps Tissue Micro	143	Hooks Skin	149
Falcon Forceps Rubber Dam Clamps	63	Forceps Towel	133	Hopkins Elevators Periosteal	113
Falcon Knives Plaster	165	Forceps Watchmaker	143	How Pliers Utility	184
Falcon Luxators	79	Forester Forceps Sponge	13-18	Howard Files Bone	118
Falcon Mallets Bone	120,124	Fotografia	152	Hygienist Scalars	21,25,26
Falcon Osteotomes Implant	124	Fox Bite Plane	152	Hylin Carvers Modeling	169
Falcon Pliers Adhesive Removing	182	Fox Ruler	55	Hylin Ceramica Carvers Modeling	169
Falcon Pliers Band Removing	181	Frahm Carvers	62	Hylin Elevators	88
Falcon Pliers Bracket Removing	182	Frames Rubber Dam	113	Hylin-Falcon Carvers Modeling	169
Falcon Pliers Detailing Step	186	Freer Elevators Periosteal	88	Hylin-Lecron Carvers Modeling	169
Falcon Pliers Ligature Forming	181	Friedman Elevators	119		
Falcon Pliers Ligature Tying	178, 179	Friedmann Rongeurs Bone	119	I	
Falcon Pliers Lingual Arch Forming	186	Friedmann-Micro Rongeurs Bone	119	ID-Color Impression Trays	153-155
Falcon Pliers Surgical Ball Hook Crimping	186	Friedmann-Mini Rongeurs Bone	21	ID-Color Silicone Buttons	155
Falcon Pliers Torquing With Key	186	Furcation KS Curettes	57	Implant Gauges	122
Falcon Pliers V-Bend Forming	186	Furrer Pliers Crown	89	Implant Osteotomes	124
Falcon Pliers Wire Bending	182,192			Implant Retractors	107
Falcon Pluggers Amalgam	48	G		Implantology Instruments	121-130
Falcon Pluggers Endodontics	31	Gallipots Stainless Steel	199	Impression Accessories	151-158
Falcon Retainers Matrix	58	Gardner Chisels Bone	120	Impression Trays Stainless Steel	153,156
Falcon Retractors Cheek	107	Gauges Bracket Positioning	174	Injectors Bone	123
Falcon Retractors Implant	107	Gauze Packers	114	Instrument Trays	196-199
Falcon Rongeur Sinus	122	Gerald Forceps Dissecting	142	Instruments for Aesthetic Restorations	38,39
Falcon Scissors	137-139	Gerald Forceps Tissue	142	Intraligamental Syringes	68,71

I	Page	M	Page	N	Page
Intraoral Photographic Mirrors	14-16	Maryland Moffit Probes Periodontal	9	Nyström Bands Matrix	58
Iris Forceps Dissecting	141	Mathieu Needle Holders	146,148	Nyström Carvers	45
Iris Forceps Tissue	142	Mathieu-Kocher Needle Holders	146,148	Nyström Retainers Matrix	58
Iris Scissors	137-139	Matrix Forceps	58		
IV Forceps Rubber Dam Clamps	63	Matrix Retainers	58	O	
IV Punches Rubber Dam	63	Matrix Strip Clamp	58	Occlusor	161
Ivory Bands Matrix	58	Mayo Scissors	140	Ochsenbein Periodontal Chisels	109
Ivory Retainers Matrix	58	Mayo-Hegar Needle Holders	146-148	Ohl Elevators Periosteal	114
Iwanson Calipers	162	McFarlane Hoes	24	Olsen-Hegar Needle Holders	146,148
		McFarlane Scalars	21	Orban Knives Gingivectomy	110
J		Mckellops Pliers Loop Forming /Bending	192	Oringer Lip and Cheek Retractors	107
Jacquette Scalars	25,26	Mead Mallets Bone	120	Orthodontics Instruments	173-194
Jacquette-Towner Scalars	25,26	Mead Rongeurs Bone	119	Orthodontics Pliers	180-187
Jarabak Pliers Wire Bending	185	Mead/West Elevators Periosteal	113	Osteotomes	120
Jars Forceps	200	Membrane Placement Instruments	129	Osteotomes Bone Condensing	125
Johnson Pliers Band Contouring	181	Meriam Tweezers	10	Osteotomes Implant	124
Jones Forceps Towel	143	Merrit Probes Periodontal	9	Osteotomes Sinus Lift	126
		Mershon Band Pushers	175		
K		Metzenbaum Needle Holders	146	P	
Keat Tweezers Buccal Tube Placing	175	Metzenbaum Scissors	137-139	P.K. Thomas Instruments	167
Kelly Forceps Haemostatic	144	Metzenbaum-Delicate Scissors	140	Parker-Langenbeck Retractors	149
Kelly Scissors	137-139	Michigan Probes Periodontal	8,9	Partsch Chisels Bone	120
Kelly-Rankin Forceps Haemostatic	144	Micro Amalgam Carriers	47	Partsch Gouges Bone	120
Key Rings	203	Micro Endodontic Applicators	33	Partsch Mallets Bone	120
Kilner Hooks Skin	149	Micro Endodontic Forceps	34	Pean Forceps Haemostatic	144
Kilner Retractors Cheek	106	Micro Forceps Dissecting	133	Pedo Scissors Crown	162
Kirkland Knives Gingivectomy	110	Micro Forceps Tissue	133	Peeso Pliers Contouring	193
Kirkland Periodontal Chisels	109	Micro Forceps Watchmaker	133	Peeso Pliers Wire Bending	193
Knives Finishing	55	Micro Instruments	131-134	Peet Splinter Forceps	34,143
Knives Gingivectomy	110	Micro Mouth Mirrors	2	Perfection Model Mouth Mirrors	2
Knives Plaster	165	Micro Needle Holders	134	Perforation Repair Instruments	33
Knives Wax	165,166	Micro Pluggers/Burnishers For Endodontics	32	Periodontal Chisels	109
Kocher Forceps Haemostatic	144	Micro Scissors	132	Periodontal Curettes	20-24
Kocher-Delicate Forceps Haemostatic	144	Micro Torches	161	Periodontal Files	109
Kocher-Langenbeck Retractors	150	Middeldorp Retractors	150	Periodontal Instruments	19-26
		Mill Bone	123	Periodontal Probes	5,8,9
L		Miller Files Bone	118	Periosteal Elevators	112-114
La Grange Scissors	137-139	Miller Forceps For Articulating Paper	57	Periotomes	78
Laboratory Instruments	159-172	Minnesota Retractors Cheek	106	Perry Tweezers	10
Laboratory Pliers	188-193	Minnesota-Simion Retractors Cheek	106	Petite Sterilization cassettes	12,196
Ladmore Burnishers	41	Minnesota-Urban Retractors Cheek	106	Photo Retractors	16,17
Langenbeck Retractors	150	Mirrors Dental	2	Pichard Elevators Periosteal	112,113
Laster Retractors Cheek	106	Mirrors Photographic	14-16	Pinze per allineatori	187
Lecluse Elevators	92	Modeling Carvers And Spatulae	167,169	Pistol-Ject Syringes Intraligamental	71
Lecron Carvers Modeling	169	Moderna Sterilization cassettes	196	P-Ject Syringes Manual Aspirating	68,71,72
Lecron-Mini Carvers Modeling	169	Molt Curettes Bone	117	Placement Instruments for Membrane	129
Lessmann Knives Wax	165,166	Molt Elevators Periosteal	112,113	Plaster Bowls	164
Lichtenstein Spatulae Plaster	164	Molt Endodontic Curettes	34	Plaster Cutters	163
Ligature Cutters	181	Molt Mouth Gags	108	Plaster Knives	165
Ligature Scissors	140	Morrel Crown Removers	56	Plaster Saws	163
Ligature Tuckers / Directors	177	Mortar And Pestle	200	Plaster Spatulae	164
Lindo-Levian Elevators	90	Mosquito Forceps Haemostatic	144	Plastic protection tube	68
Lister Scissors Bandage	140	Mosquito-Micro Forceps Haemostatic	144	Pliers Adhesive Removing	182
Littauer Scissors Ligature	140	Mouth Gags	108	Pliers Arrow Clasp Forming/Bending	193
Locklin Scissors	138	Mouth Mirror Handles	3,4	Pliers Band Removing	181
London Hospital Elevators	90	Mouth Mirrors	2	Pliers Bracket Removing	182
Lucas Curettes Bone	115,116	Mouth Mirrors Micro	2	Pliers Crown	57,162
Luer Rongeurs Bone	119	Mouth Props	108	Pliers Detailing Step	186
Luxating Hybrids	76,77			Pliers Distal End Bending (Hammer head)	183
Luxators	79			Pliers Elastomeric Placing	178, 179
		N		Pliers Laboratory	188-193
M		Nabers Probes Periodontal	8	Pliers Ligature Forming	181
Mallets Bone	120,124	Nance Pliers Loop Forming /Bending	185	Pliers Ligature Tying	178, 179
Mallets Riveting	163	Needle Holders	145-148	Pliers Lingual Arch Forming	186
Manici Per Sindesmotomo	80	Needle Holders Micro	134	Pliers Orthodontics	180-187
Manual Aspirating Syringes	70,72,73	Needle Re-cappers	74	Pliers Surgical Ball Hook Crimping	186
Margin Trimmers	45,54	NiTi Endodontic Instruments	28-29	Pliers Torquing With Key	186
Markley Amalgam Pluggers	48	Non-aspirating syringe	73	Pliers Universal	188,189
		Noyes/Castroviejo Scissors	132		

Descriptive Index

P	Page	S	Page	T	Page
Pliers Utility	183,184	Scissors Micro	132	Towel Holders/Chains	203
Pliers V-Bend Forming	186	Seldin Elevators	88	Towner Scalers	25,26
Pliers Wire Bending	181-193	Seldin Elevators Periosteal	114	Tray For Rubber Dam Clamps	59
Pluggers Amalgam	40,48	Self Aspirating Syringes	69,71	Trays Endodontic	36
Pluggers Endodontics	29	Semken Forceps Dissecting	141	Trays Instruments	196-199
Pocket Marking Tweezers	120	Semken Forceps Tissue	142	Trays Kidney	199
Posters	204	Senn-Miller Retractors	149	Tuckers Ligature	177
Potts Elevators	91	Separators Placing Pliers	178	Tungsten Carbide Burs HP	170-172
Probes	150	Sets Rubber Dam Instruments	64,65,66	Tunneling instruments	111
Probes Implant Depth	122	Shepherd Retractor	106	Tweed Pliers Loop Forming /Bending	185
Probes Periodontal	5,8,9	Silver Points Forceps	34	Tweed/Angle Pliers Arch Forming	185
Probes Surgical	150	Simplex Retractors Cheek	17	Tweezers Bracket Placing	175
Projection-System Syringes Self Aspirating	69	Simplex-Falcon Retractors Cheek	17	Tweezers Buccal Tube Placing	175
Punches Rubber Dam	63	Sindesmotomi	80	Tweezers Bur Holding	201
		Sinus Lift Curettes	127,128	Tweezers Cotton	10
R		Sinus Lift Elevators	127,128	Tweezers Elastomeric Ligature Removing	178
Racks For Instruments	197-198	Sinus Lift Osteotomes	126	Tweezers Endodontics	34
Racks For Pliers	194	Sinus Rongeurs	122	Tweezers Extraction	104
Racks For Trays	197-198	Skin Hooks	149	Tweezers For Membrane Placement	129
Reamers Endodontics	29	Smaha Pliers Ligature Tying	179	Tweezers Pocket Marking	120
Remover Elastomeric Ligature	177	SOFT-LINE Curettes Bone	115	Tweezers Soldering	163
Removers Crown	56	SOFT-LINE Endodontic Instruments	30-34	TWIST-LOCK Sterilization cassettes	196
Restorative Instruments	37-66	Soldering Tweezers	163		
Retainers Matrix	58	Spatulae Alginate	164	U	
Retractors Cheek and Lip	16,17	Spatulae Cement	53	Ultima Needle Re-cappers	74
Retractors Endodontic	33	Spatulae Plaster	164	UNC Probes Periodontal	9
Retractors Implant	107	Spatulae Plaster	164	Universal Curettes	24
Retractors Photo	16,17	Spencer Scissors Ligature	140	Universal Scissors Bandage	140
Retractors Self-Retaining	150	Splinter Forceps	34,143	University of Minnesota Retractors Cheek	106
Retractors Tissue And Skin	149,150	Sponge Forceps	143	USA Model Impression Trays	153,156
Reynolds Pliers Band Contouring	181	Spreaders Crown	57	USC Knives Finishing	55
Rhodes Periodontal Chisels	109	Spreaders Endodontics	29		
Rings Color Coding	196	SS-2000 Syringes	68-70	V	
Riveting Mallets	163	Standard Scalers	26	Vehe Carvers Modeling	167
Roach Carvers Modeling	167	Standard Scissors	140	Vernier Calipers	174
Rochester-Pean Forceps Haemostatic	144	Stands Burs	201		
Roghe Spatulae Plaster	164	Sterilizing And Sundries	195-204	W	
Rongeurs Bone	119	Sterilizing Forceps	200	Wakefield Osteotomes	120
Rongeurs Sinus	122	Sternberg Retractors Cheek	107	Waldsachs Pliers Universal	188
Roser-König Mouth Gags	108	Stieglitz Splinter Forceps	143	Walter F. Barry Elevators	92
Routurier Forceps Extraction	104	Stokes Forceps Rubber Dam Clamps	63	Ward Retractors Cheek	106
Rubber Dam Clamp Forceps	63	Stokes/Palmer Forceps Rubber Dam Clamps	63	Wards Amalgam Pluggers	48
Rubber Dam Clamps	59,60,61	Strabismus Scissors	137	Wards Carvers	55
Rubber Dam Clamps Tray	59	Strumentti per Soft Brushing	130	Warwick-James Elevators	86,90
Rubber Dam Frames	62	Super Amalgam Pluggers	40	Wax Knives	165
Rubber Dam Instruments	59-66	Super-Cut Scissors	138	Weingart Pliers Utility	183
Rubber Dam Instruments Sets	64,65,66	Surgery Instruments	135-150	Weitlaner Retractors Self-Retaining	150
Rubber Dam Punches	63	Suture Forceps	120	Well Amalgam	47
Rubber Dam Template	63	Swedish Micro Vascular Needle Holders	145	Well Bone	123
Ruddle Endodontic Curettes	34	Swiss Model Amalgam Carrier	47	Wescott Burnishers	41,49
Rulers	174	Syringes Anaesthesia	68-73	Weston Cement Spatulae	53
		Syringes Intraligamental	68,71	White Burnishers	41,49
S		Syringes Manual Aspirating	70,72,73	WHO Probes Periodontal	5,8,9
Sacks Knives Plaster	165	Syringes Self Aspirating	69,71	Wicks For Alcohol Lamps	161
Saws Laboratory	163			Wieder Depressors Tongue	108
Scalers	21,24-26	T		Wiland Carvers	55
Scalpel Blades	136	Tanner Amalgam Pluggers	40	Williams Probes Periodontal	8,9
Scalpel Handles	110,136	Tanner Knives Finishing	55	Williger Curettes Bone	117
Scalpels	136	Taylor Scalers	25	Williger Elevators Periosteal	114
Schaedel Forceps Towel	143	Template Rubber Dam	63	Winter Elevators	92
Schlemmer Elevators	91	TG Periodontal Chisels	109	Wire Bending Pliers	181-193
Schmeckebier Elevators	88	Tissue Forceps	141,142	Wire Cutters	180,188,189
Schwarz Pliers Arrow Clasp Forming/Bending	193	Tissue Retractors	149,150	Witzel Forceps Extraction	104
Schwarz Pliers Loop Forming /Bending	191,192	Toennis Needle Holders	146	Woodson Filling Instruments	51
Scissors	137-140	Tofflemire Retainers Matrix	58	Wynman-Falcon Forceps Crown	57
Scissors Bandage	140	Tongs	163		
Scissors Crown	162	Tongue Depressors	108	X	
Scissors Ligature	140	Towel Forceps	143	X-Ray Clips	203



X	Page
X-Ray Hangers	203
Y	
Young Frames Rubber Dam	62
Young Pliers Loop Forming /Bending	193
Younger-Good Scalers	25
Z	
Zahle Carvers Modeling	168

Indice Per Descrizione

A	Page
Abbassalingua	108
Acorn/Wescott Brunitori	41,49
Adams Pinze Per Piegare	190
Aderer Pinze Per Anse Chiuse	193
Aderer Pinze Per Piegare	191
Adson Pinzette Anatomiche	141
Adson Pinzette Chirurgiche	141,142
Adson-Brown Pinzette Chirurgiche	142
Adson-Fraser Pinze Emostatiche	144
Adson-Micro Pinzette Anatomiche	141
Adson-Micro Pinzette Chirurgiche	141,142
Ainsworth Pinze Per Forare La Diga	63
Albrecht Pinzette Per Estrazione	104
Allen Scollaperiostei	112
Alm Divaricatori Autostatici	150
Anelli Di Identificazione	196
Anestesia-Siringhe	67-74
Angle Pinze Per Piegare	182,192
Apical Leve Per Radici	87
Appendiadiografie	203
Applicatore Per Legature Elastiche	177
Applicatore Per Micro Endodonzia	33
Applicatori Di Osso Triturato	128
Applicatori Per Sottofondo	50
Apribocca	108
Apricorone	57
Articolatori	160,161
Austin Divaricatori Per Guance	106
Austin-Kay Divaricatori Per Guance	106

B	Page
Baby-Crilewood Porta Aghi	146
Backhaus Pinze Per Pannolino	143
Base Riponi Ago	74
Baumgartner Porta Aghi	146,147
Beale Strumenti Per Modellare	167
Beavertail Brunitori	49
Bee Bee Forbici Per Corone	162
Beerendonk Calibro	174
Bein Leve Per Radici	85,87,89,91
Bernhard Leve Per Radici	86
Bernklau Righello	174
Beyer Pinze Ossivore Alveolotome	119
Bishop Divaricatori Per Guance	106,107
Bisturi	136
Bisturi Per Gengivectomia	110
Black Otturatori Per Amalgama	40,48
Blacks Finitore Per Bordi Gengivali	54
Blumenthal Pinze Ossivore Alveolotome	119
Boghosian Strumenti Per Otturazioni	42
Bohm Pinze Per Corone	162
Boley Calibri	162
Bone Scrapers	123
Boone Calibro Per Posizionamento Attacchi	174
Bottoni In Silicone Per Porta Impronte	155
Bowdler-Henry Divaricatori	106
Boynton Porta Aghi	148
Brass Series Siringhe	71-73
Brewer Pinze Per Uncini	63
Bruenings Abbassalingua	108
Brunitori	41,49,50
Busar Scollaperiostei	112

C	Page
Calibri	162,174
Calibro Facciale	152
Calibro Per Implantologia	122
Calibro Per Posizionamento Attacchi	174

C	Page
Carvers (per modellare e rifinire otturazioni)	45,55
Cassette' Inox Per Sterilizzare	12,196
Castroviejo Porta Aghi	145,147
Castroviejo Spessimetri Per Osso	122
Catenella Per Mantelline	203
Cattoni Sonde Millimetriche	8
Cawood-Minnesota Divaricatori Per Guance	106
Cawood-Minnesota Müller Divaricatori Per Guance	106
Cesoie Per Osso	120
Cesoie Taglia Gesso	163
Cheatle Pinze Per Sterilizzazione	200
Chirurgia dentale	105-120
Chompret Syndesmotomes	80
Cleoidi -Discoidi	55
Cleveland Cesoie Per Osso	120
Coleman Leve Per Radici	90
College Pinzette Per Medicazione	10
College-TOE Pinzette Per Medicazione	10
Collin Pinze Per Sterilizzazione	200
Coltelli Per Cera	165,166
Coltelli Per Gesso	165
Columbia Curettes	24
Columbia Divaricatori Per Guance	107
Compasso Separatore Ortodontico	174
Compattatori Per Osso	128
Compo-Art Strumenti Per Otturazioni	38,39
Compo-Fill Strumenti Per Otturazioni	40-44
Conservativa-Strumenti	37-66
Contenitori In Acciaio Inox	199
Contenitori Per Disinfettare Le Frese	201
Contenitori Per Endodonzia	36
Contenitori Per Frese	201
Contenitori Per Pinze	200
Coupland Leve Per Radici	86,87
Crane-Kaplan Levatartaro	25
Crile Pinze Emostatiche	144
Crile-Rankin Pinze Emostatiche	144
Crilewood Porta Aghi	145,147
Cryer Leve Per Radici	86,87,90
Cucchiai Alveolari	115-117
Curette sopra-gengivali a "zappa"	24
Curettes Per Endodonzia	34
Curettes Per Parodontologia	20-24
Curettes Per Rialzo Del Seno	127,128
Curettes Universali	24

D	Page
Dappen In Vetro	200
Darby Perry Levatartaro	26
De Bakey Pinzette Atraumatiche	141
De La Rosa Pinze Di Per Contornare Archi	184
Derf Porta Aghi	145,147
Diagnostica-Strumenti	1-12
Direzionatori Di Legature	177
Disc-System Siringhe Autoaspiranti	69,71
Distributori Di Bicchieri	200
Distributori Di Cotone	202
Divaricatori	149,150
Divaricatori Autostatici	150
Divaricatori in silicone	108
Divaricatori Per Endodonzia	33
Divaricatori per fotografia	16,17
Divaricatori Per Implantologia	107
Divaricatori Per Labbra e Guance	16,17
Dolphin Pinze Universale	188

E	Page
Easy-Color Manici Per Specchietti	3,4

E	Page
Easy-Color Strumenti Per Implantologia	129
Easy-Color Strumenti Per Otturazioni	38-46
Easy-Color Strumenti Per Parodontologia	20,21
Ehricke Mod. Porta Impronte	156,157
Endodonzia-Strumenti	27-36
Ermerit Coltelli Per Cera	165
Escavatori	46,54
Escavatori Endodontici	30
Estrazione Atraumatica	75-82
Estrazione-Strumenti	83-104
Euro Siringhe Ad Aspirazione Manuale	70,73
Expros (Combinazione Sonde/Sonde millimetriche	8

F	Page
Fahnenstock Coltelli Per Cera	165,166
Falcon Apricorona	57
Falcon Articolatori	160
Falcon Brunitori	49
Falcon Calibro	174
Falcon Calibro Facciale	152
Falcon Cesoie Per Osso	120
Falcon Coltelli Per Gesso	165
Falcon Curettes Per Rialzo Del Seno	127
Falcon Divaricatori Per Guance	107
Falcon Divaricatori Per Implantologia	107
Falcon Escavatori	54
Falcon Escavatori Endodontici	30
Falcon Forbici	137-139
Falcon Levacorone	56
Falcon Leve Per Radici	85
Falcon Luxators	79
Falcon Martelli Chirurgici	120,124
Falcon Osteotomi Per Implantologia	124
Falcon Otturatore Per Canali	31
Falcon Otturatori Per Amalgama	48
Falcon Pinze Per Formare Archi Linguali	186
Falcon Pinze Per Formare Le Legature	181
Falcon Pinze Per Grippare Ganci Chirurgici E Stop	186
Falcon Pinze Per La Rimozione Di Attacchi	182
Falcon Pinze Per La Rimozione Di Bande	181
Falcon Pinze Per Legature	178, 179
Falcon Pinze Per Matrice	58
Falcon Pinze Per Piegare	182,192
Falcon Pinze Per Piegare I Distali (Hammer head)	183
Falcon Pinze Per Piegatura A Baionetta	186
Falcon Pinze Per Piegatura A V	186
Falcon Pinze Per Rialzo Del Seno	122
Falcon Pinze Per Rimuovere Residui Di Adesivo	182
Falcon Pinze Per Torquing Con Chiave	186
Falcon Pinze Per Uncini	63
Falcon Pinzette Per Carta Da Articolazioni	57
Falcon Pinzette Per Posizionare Tubi Buccali	175
Falcon Porta Matrice	58
Falcon Scollatori Per Rialzo Del Seno	127
Falcon Spatole Per Alginato	164
Falcon Spatole Per Gesso	164
Falcon Spessimetri Per Osso	122
Falcon Spreaders Per Canalari	32
Falcon Strumenti Per Modellare	167,168
Falcon Strumenti Per Otturazioni	42,51,52
Falcon-Cut Forbici	137
Falcon-Cut Pinze	180,181,188
Falcon-Grip Pinze	183,190
Falcon-Grip Pinzette Anatomiche	141
Falcon-Grip Pinzette Chirurgiche	141
Falcon-Grip Porta Aghi	145,146
Falcon-Grip Porta Aghi Micro	134
Falcon-ject Ultima Siringhe Intraligamentali	68

F	Page
Falcon-Sternberg Divaricatori Per Guance	107
Farabeuf Divaricatori	149
Ferrier Finitore Per Bordi Gengivali	54
Finitore Per Bordi Gengivali	45,54
Fischer Strumenti Per Filo Retrattore	152
Fisher Pinze Di Per Anse Chiuse	192
Flagg Pinzette Per Medicazione	10
Flohr Leve Per Radici	86,88,91
Forbici	137-140
Forbici Micro	132
Forbici Per Corone	162
Forbici per Fasce	140
Forbici per legature	140
Forester Pinza Porta Spugna	143
Fox Piano di Occlusione	152
Fox Regolo	152
Frahm Carvers	55
Freer Scollaperiostei	113
Fresoni In Tungsteno HP	170-172
Friedman Leve Per Radici	88
Friedmann Pinze Ossivore Alveolotome	119
Friedmann-Micro Pinze Ossivore Alveolotome	119
Friedmann-Mini Pinze Ossivore Alveolotome	119
Furcation KS Currettes	21
Furrer Pinze Per Corone	57

G	Page
Gardner Scalpelli Per Osso	120
Gerald Pinzette Anatomiche	142
Gerald Pinzette Chirurgiche	142
Gillies Porta Aghi	148
Gillies Uncini Cutanei	149
Goldman-Fox Cesoi Per Osso	120
Goldman-Fox Curette sopra-gengivali a "zappa"	24
Goldman-Fox Forbici	137-139
Goldman-Fox Levatartaro	25
Goldman-Fox Pinzette Per Marcare Le Tasche	120
Goldman-Fox Scollaperiostei	113
Goldman-Fox Sonde Millimetriche	8,9
Goldstein Strumenti Per Otturazioni	42,43
Gracey Currettes	20-23
Gregg Strumenti Per Otturazioni	42,51
Griglia Per Strumenti	197-198
Gritman Coltelli Per Gesso	165
Gritman Strumenti Per Modellare	167
Gross-Maier Pinze Porta Tamponi	143

H	Page
Halsey Porta Aghi	145
Halsted Mosquito Pinze Emostatiche	144,179
Handles For Syndesmotomes Tips	80
Hartmann Pinze Emostatiche	144
Hedstrom Lime	28
Heidebrink Leve Per Radici	86,93
Heidemann Strumenti Per Otturazioni	43,44,51,52
Heister Apribocca	108
Hemingway Cucchiali Alveolari	115,116
Henahan Divaricatori	107
Hilger Divaricatori Per Guance	107
Hirschfield Scollaperiostei	113
Hollenback Carvers	55
Hollenback Otturatori Per Amalgama	40
Hollow Chop Pinze Per Formare Archi	184
Hopkins Scollaperiostei	113
How Pinze Universale	184
Howard Lime Per Osso	118
Hygenist Levatartaro	21,25,26
Hylin Ceramica Strumenti Per Modellare	169

H	Page
Hylin Leve Per Radici	88
Hylin Strumenti Per Modellare	169
Hylin-Falcon Strumenti Per Modellare	169
Hylin-Lecron Strumenti Per Modellare	169

I	Page
ID-Color Bottoni in Silicene	
ID-Color Porta Impronte	155
Impronta-Accessori	153-155
Intiettori per Osso	151-158
Iris Forbici	123
Iris Pinzette Anatomiche	137-139
Iris Pinzette Chirurgiche	141
IV Pinze Per Forare La Diga	142
IV Pinze Per Uncini	63
Ivory Matrici	63
Ivory Porta Matrice	58
Iwanson Calibri	58
	162

J	Page
Jacquette Levatartaro	
Jacquette-Towner Levatartaro	25,26
Jarabak Pinze Per Piegare	25,26
Johnson Pinza Per Contornare Le Bande	185
Jones Pinze Per Pannolino	181
	143

K	Page
Kappen In Vetro	
Keat Pinzette Per Posizionare Tubi Buccali	200
Kelly Forbici	175
Kelly Pinze Emostatiche	137-139
Kelly-Rankin Pinze Emostatiche	144
Kilner Divaricatori Per Guance	144
Kilner Uncini Cutanei	106
Kirkland Bisturi Per Gengivectomia	149
Kirkland Scalpelli Per Parodontologia	110
Kocher Pinze Emostatiche	109
Kocher-Delicate Pinze Emostatiche	144
Kocher-Langenbeck Divaricatori	144
	150

L	Page
La Grange Forbici	137-139
Laboratorio-Strumenti	159-172
Ladmore Brunitori	41
Lame Per Bisturi	136
Lame Per Seghetto	163
Lampade Ad Alcool	161
Langenbeck Divaricatori	150
Laster Divaricatori Per Guance	106
Lecluse Leve Per Radici	92
Lecron Strumenti Per Modellare	169
Lecron-Mini Strumenti Per Modellare	169
Lessmann Coltelli Per Cera	165,166
Levatartaro (Scaler)	21,24-26
Leve Ibride	76,77
Leve Per Frammenti	93
Leve Per Radici	85-93
Lichtenstein Spatole Per Gesso	164
Lime Per Canalari	28
Lime Per Osso	118
Lime Per Parodontologia	109
Lindo-Levin Leve Per Radici	90
Lister Forbici per Fasce	140
Littauer Forbici per legature	140
Locklin Forbici	138
London Hospital Leve Per Radici	90
Lucas Cucchiali Alveolari	115,116
Luer Pinze Ossivore Alveolotome	119

L	Page
Luxators	119
	79

M	Page
Manici per bisturi	
Manici Per Microlame	110,136
Manici Per Specchietti Foto Intraorali	132
Manici Per Specchietti Per Bocca	16
Markley Otturatori Per Amalgama	3,4
Martelletti Per Rivettare	48
Martelli Chirurgici	163
Maryland Moffit Sonde Millimetriche	120,124
Mathieu Porta Aghi	9
Mathieu-Kocher Porta Aghi	146,148
Matrici	146,148
Mayo Forbici	58
Mayo-Hegar Porta Aghi	140
McFarlane Curette sopra-gengivali a "zappa"	46-148
McFarlane Levatartaro	24
Mckellops Pinze Di Per Anse Chiuse	21
Mead Martelli Chirurgici	192
Mead Pinze Ossivore Alveolotome	120
Mead/West Scollaperiostei	119
Meriam Pinzette Per Medicazione	113
Merrit Sonde Millimetriche	10
Mershon Spingibanda	9
Metzenbaum Forbici	175
Metzenbaum Porta Aghi	137-139
Metzenbaum-Delicate Forbici	146
Michigan Sonde Millimetriche	140
Micro Applicatore Per Endodonzia	8,9
Micro Bruciatori	33
Micro Forbici	161
Micro Otturatore/Brunitore Per Endodonzia	132
Micro Pinze Per Endodonzia	32
Micro Pinzette Anatomiche	34
Micro Pinzette Chirurgiche	133
Micro Pinzette Watchmaker	133
Micro Porta Aghi	133
Micro Specchietti Per Bocca	134
Micro Strumenti	2
Middeldorff Divaricatori	131-134
Miller Lime Per Osso	150
Miller Pinzette Per Carta Da Articolazioni	118
Minnesota Divaricatori Per Guance	57
Minnesota-Simion Divaricatori Per Guance	106
Minnesota-Urban Divaricatori Per Guance	106
Misuratore Per Canali	106
Modello Inglese Spingi Amalgama	35
Modello Svizzero Spingi Amalgama	47
Modello Tedesco Spingi Amalgama	47
Moderna Cassette	47
Molt Apribocca	196
Molt Cucchiali Alveolari	108
Molt Currettes Per Endodonzia	117
Molt Scollaperiostei	34
Morrel Levacorone	112,113
Morsetto Per Matrici	56
Mortaio E Pestello	58
Mortaio Per Amalgama	200
Mortaio Per Osso	47
Mosquito Pinze Emostatiche	123
Mosquito-Micro Pinze Emostatiche	144

N	Page
Nabers Sonde Millimetriche	8
Nance Pinze Di Per Anse Chiuse	185
NI-Ti-Strumenti Canalari	28-29
Noyes/Castroviejo Forbici	132

Indice Per Descrizione

N	Page
Nyström Carvers	45
Nyström Matrici	58
Nyström Porta Matrice	58

O	Page
Occlusore	161
Ochsenbein Scalpelli Per Parodontologia	109
Ohi Scollaperiosteï	114
Olsen-Hegar Porta Aghi	146,148
Orban Bisturi Per Gengivectomia	110
Oringer Divaricatori Per Labbra e Guance	107
Orthodonzia-Strumenti	173-194
Osteotomi	120
Osteotomi Per Condensazione	125
Osteotomi Per Implantologia	124
Osteotomi Per Rialzo Del Seno	126
Otturatore Per Canali	29
Otturatore/Brunitore Per Micro Endodonzia	32
Otturatori Per Amalgama	40,48

P	Page
P.K. Thomas Strumenti Per Modellare	167
Parker-Langenbeck Divaricatori	149
Parodontologia-Strumenti	19-26
Partsch Martelli Chirurgici	120
Partsch Scalpelli Per Osso	120
Partsch Sgorbie Per Osso	120
Pean Pinze Emostatiche	144
Pedo Forbici Per Corone	162
Peeso Pinze Per Contornare	193
Peeso Pinze Per Piegare	193
Peet Pinze Per Frammenti	34,143
Perfection Specchietti Per Bocca	2
Periotomi	78
Perry Pinzette Per Medicazione	10
Pelite Cassette	12,196
Photography	13-18
Piastra In Vetro Per Miscelazione	53
Piatto Per Forare La Diga	63
Pichard Scollaperiosteï	112,113
Pinze Da Laboratorio	188-193
Pinze Emostatiche	144
Pinze Ossivore Alveolotome	119
Pinze Per Cilindri E Muffole	163
Pinze Per Corone	57,162
Pinze Per Endodonzia	34
Pinze Per Estrazione	94-104
Pinze Per Estrazione Atraumatiche	81,82
Pinze Per Estrazione Con Manico Anatomico	102-103
Pinze Per Estrazione Modello Europeo	97-101
Pinze Per Estrazione Per Bambini	94-96
Pinze Per Forare La Diga	63
Pinze Per Formare Archi Linguali	186
Pinze Per Formare Le Legature	181
Pinze Per Frammenti	34,143
Pinze Per Griappare Ganci Chirurgici E Stop	186
Pinze Per La Rimozione Di Attacchi	182
Pinze Per La Rimozione Di Bande	181
Pinze Per La Rimozione Di Corpi	34
Pinze per lame bisturi	136
Pinze Per Legature	178, 179
Pinze Per Matrici	58
Pinze Per Orthodonzia	180-187
Pinze Per Pannilino	143
Pinze Per Piegare	181-193
Pinze Per Piegare Ganci A Freccia	193
Pinze Per Piegare I Distali (Hammer head)	183
Pinze Per Piegatura A Baionetta	186

P	Page
Pinze Per Piegatura A V	186
Pinze Per Rialzo Del Seno	122
Pinze Per Rimuovere Residui Di Adesivo	182
Pinze Per Sterilizzazione	200
Pinze Per Tendere Elastici	178
Pinze Per Torquing Con Chiave	186
Pinze Per Uncini	63
Pinze Porta Spugna	143
Pinze Porta Tamponi	143
Pinze Riposizionatrici Di Osso	122
Pinze Universali	188,189
Pinze Utilita/Universale	183,184
Pinzette Anatomiche	141,142
Pinzette Anatomiche Micro	133
Pinzette Atraumatiche	141
Pinzette Chirurgiche	141,142
Pinzette Chirurgiche Micro	133
Pinzette Per Carta Da Articolazioni	57
Pinzette Per Endodonzia	34
Pinzette Per Estrazione	104
Pinzette Per Marcare Le Tasche	120
Pinzette Per Medicazione	10
Pinzette Per Posizionamento Della Membrana	129
Pinzette Per Posizionare Attacchi	175
Pinzette Per Posizionare Tubi Buccali	175
Pinzette Per Radiografie	203
Pinzette Per Rimuovere Le Legature	178
Pinzette Per Saldatura	163
Pinzette Per Sutura	120
Pinzette Per Trattenere Le Frese	201
Pistol-Ject Siringhe Intraligamentali	71
P-Ject Siringhe Ad Aspirazione Manuale	68,71,72
Pliers for aligners	187
Pluggers Per Canali	29
Porta Aghi	145-148
Porta Aghi Micro	134
Porta Chiavi	203
Porta Frese	201
Porta Impronte In Acciaio Inox	153,156
Porta Matrici	58
Porta Strumenti Canalari	35
Posters	204
Potts Leve Per Radici	91
Projection-System Siringhe Autoaspiranti	69
Protezione In Plastica	68
Pulitore Per Strumenti Canalari	35

R	Page
Raccoglitori Per Osso	123
Rastrelliera Per Vassoï	197-198
Reamers Per Canalari	29
Reynolds Pinza Per Contornare Le Bande	181
Rhodes Scalpelli Per Parodontologia	109
Righelli	174
Roach Strumenti Per Modellare	167
Rochester-Pean Pinze Emostatiche	144
Roghe Spatole Per Gesso	164
Roser-König Apribocca	108
Routurier Pinze Per Estrazione	104
Ruddle Curettes Per Endodonzia	34

S	Page
Sacks Coltelli Per Gesso	165
Scalpelli Per Osso	120
Scalpelli Per Parodontologia	109
Schaedel Pinze Per Pannilino	143
Schlemmer Leve Per Radici	91
Schmeckebier Leve Per Radici	88

S	Page
Schwarz Pinze Di Per Anse Chiuse	191,192
Schwarz Pinze Per Piegare Ganci A Freccia	193
Scollaperiosteï	112-114
Scollatori Per Rialzo Del Seno	127,128
Seghetti Di Laboratorio	163
Seghetti Per Gesso	163
Seldin Leve Per Radici	88
Seldin Scollaperiosteï	114
Semken Pinzette Anatomiche	141
Semken Pinzette Chirurgiche	142
Senn-Miller Divaricatori	149
Set Di Strumenti Per Diga	64,65,66
Set Di Strumenti Per Estrazione	84
Set Strumenti Prima Visita	11,12
Sgorbie Per Osso	120
Shephard Divaricatori	106
Simplex Divaricatori Per Guance	17
Simplex-Falcon Divaricatori Per Guance	17
Siringa non aspirante	73
Siringhe Ad Aspirazione Manuale	70,72,73
Siringhe Autoaspiranti	69,71
Siringhe Intraligamentali	68,71
Siringhe Per Anestesia	68-73
Smaha Pinze Per Legature	179
Soft brushing instruments	130
SOFT-LINE Cucchiari Alveolari	115
SOFT-LINE Strumenti Per Endodonzia	30-34
Sonde	5-7
Sonde Millimetriche	5,8,9
Sonde Per Canali	30
Sonde Per Chirurgia	150
Sonde Per Implantologia	122
Spatole Per Alginato	164
Spatole Per Gesso	164
Spatoline Per Cemento	53
Specchi Per Foto Interorali	14-16
Specchietti Per Bocca	2
Specchietti Per Bocca Micro	2
Spencer Forbici per legature	140
Spessimetri Per Osso	122
Spingi Amalgama	47
Spingi Amalgama Per Micro Otturazioni	47
Spingibanda	175,176
Spreaders Per Canalari	29
SS-2000 Siringhe	68-70
Standard Forbici	140
Standard Levatartaro	26
Sterilizzazione E Varie	195-204
Sternberg Divaricatori Per Guance	107
Stieglitz Pinze Per Frammenti	143
Stokes Pinze Per Uncini	63
Stokes/Palmer Pinze Per Uncini	63
Stoppini Di Ricambio Per Lampade Ad Alcool	161
Strabismus Forbici	137
Strumenti Per Diga	59-66
Strumenti Da Smalto	45,54
Strumenti di contrasto	18
Strumenti Levacorone	56
Strumenti Per Ceramica	166
Strumenti Per Chirurgia	135-150
Strumenti per Conservativa Estetica	38,39
Strumenti Per Corone	56,57
Strumenti per cure canalari	33
Strumenti Per Filo Retrattore	152
Strumenti Per Implantologia	121-130
Strumenti Per Impronta Di Silicone	152
Strumenti Per Modellare	167,169
Strumenti Per Otturazioni	40-53

S	Page
Strumenti Per Posizionamento Della Membrana	129
Strumenti Per Rifinire	55
Strumenti Per Rimuovere Otturazioni	39
Strumenti Per Tunneling	111
Strumento Per L'Applicazione Medicamenti	50
Strumento per piegature distali	176
Strumento Per Rimuovere Elastici	177
Strumento Per Rimuovere L'Adesivo	176
Super Otturatori Per Amalgama	40
Super-Cut Forbici	138
Supporto Per Pinze	194
Swedish Micro Vascular Porta Aghi	145
Syndesmotomes	80

T	
Tamponatori	114
Tanner Otturatori Per Amalgama	40
Tanner Strumenti per rifinire	55
Taylor Levatartaro	25
Tazze In Acciaio Inox	199
Tazze Per Alginato	164
Tazze Per Gesso	164
Telai Per Diga	62
TG Scalpelli Per Parodontologia	109
Toennis Porta Aghi	146
Tofflemire Porta Matrice	58
Towner Levatartaro	25,26
Trimmer per il margine gengivale	45,54
Trituratore Per Osso	123
Tronchesini Distali	180
Tronchesino Per Filo	180,188,189
Tronchesino Per Legature	181
Tweed Pinze Di Per Anse Chiuse	185
Tweed/Angle Pinze Per Formare Archi	185
TWIST-LOCK Cassette	196

U	
Ultima Base Riponi Ago	74
UNC Sonde Millimetriche	9
Uncini Cutanei	149
Uncini Per Diga	59,60,61
Universal Forbici per Fasce	140
University of Minnesota Divaricatori Per Guance	106
USA Mod. Porta Impronte	153,156
USC Strumenti per rifinire	55

V	
Vassoi Porta Strumenti	196-199
Vassoi Reniformi	199
Vassoio Endodontico	36
Vassoio Porta Uncini	59
Vehe Strumenti Per Modellare	167

W	
Wakefield Osteotomi	120
Waldsachs Pinze Universale	188
Walter F. Barry Leve Per Radici	92
Ward Divaricatori Per Guance	106
Wards Otturatori Per Amalgama	48
Wards Strumenti Per Modellare	55
Warwick-James Leve Per Radici	86,90
Weingart Pinze Universale	183
Weitlaner Divaricatori Autostatici	150
Wescott Brunitori	41,49
Weston Spatoline Per Cemento	53
White Brunitori	41,49
WHO Sonde Millimetriche	5,8,9
Wieder Abbassalingua	108

W	Page
Wiland Strumenti per Modellare	55
Williams Sonde Millimetriche	8,9
Williger Cucchiari Alveolari	117
Williger Scollaperioste	114
Winter Leve Per Radici	92
Witzel Pinze Per Estrazione	104
Woodson Strumenti Per Otturazioni	51
Wynman-Falcon Pinze Per Corone	57

Y	
Young Pinze Per Anse Chiuse	193
Young Telai Per Diga	62
Younger-Good Levatartaro	25

Z	
Zahle Strumenti Per Modellare	168

Falcon reserve the right to improve the function or design of any instrument without prior notice and will not be responsible for any typographical inaccuracies.

La Falcon si riserva di migliorare la funzionalità o la forma di qualsiasi strumento in catalogo senza preavviso e declina ogni responsabilità per eventuali inesattezze ortografiche.



Falcon Medical Italia Srl.

Office address / Sede operativa:
Via S. Donato, 2045
55100 Lucca, Italy
tel: +39 0583 490459
+39 0583 511023
fax: +39 0583 463628
info@falconmedical.it
www.falconmedical.it

Legal address / Sede legale:
Via dei Bichi, 340
55100 S. Marco, Lucca - Italy

Edition 3/2012

Copyright © Falcon Medical Italia Srl. 2012
Reprinting of this catalogue even partially is not allowed
www.hueblue.com